



- Rectangular caps
- Rocker-action pushbutton cap
- 12.5 mm x 10.1 mm; 18.65 mm x 10.1 mm; 25.0 mm x 10.1 mm
- h = 12.2 mm
- Material: ABS/polycarbonate
- Temp. Range:
  - Solid cap: -40/+65°C
  - Transparent cap: -40/+85°C
- Panel cut-out: 1A/1H-13.0 x 10.5, 1M-25.7 x 10.5, 1ZA-19.4x10.5

All dimensions in mm

Tolerances +/-0.2mm

### DIMENSIONS

#### SMD w/LED + 1A

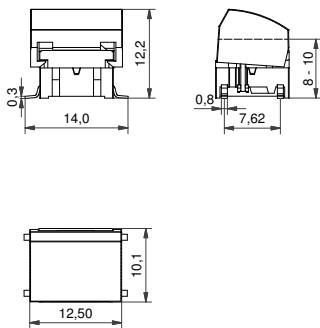

#### TH w/LED + 1H

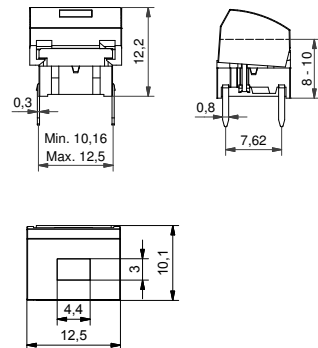

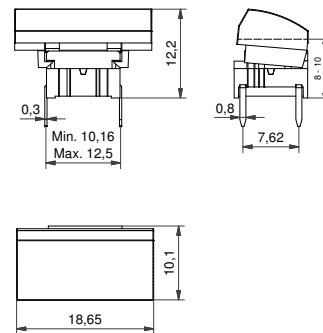

#### TH + 1ZA

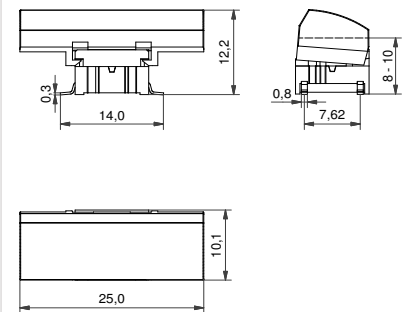

#### SMD + 1M





### ILLUMINATED – HOW TO ORDER

Switch	Mounting	Actuation force	LED	+	Cap	Colour code 1H	Lens 1H
<b>5 G</b>	<input type="checkbox"/> <input type="checkbox"/> <input type="checkbox"/>	<input type="checkbox"/> <input type="checkbox"/>	<input type="checkbox"/> <input type="checkbox"/> <input type="checkbox"/> <input type="checkbox"/>		<input type="checkbox"/> <input type="checkbox"/>	<input type="checkbox"/> <input type="checkbox"/>	<input type="checkbox"/>
	<b>TH9</b> through-hole <b>SH9</b> surface mount	<b>20</b> <b>35</b> <b>65</b> <b>Q*</b>	<b>02</b> blue <b>22</b> green <b>42</b> yellow <b>61</b> white <b>82</b> red <b>2242</b> green/yellow <b>8222</b> red/green <b>8242</b> red/yellow		<b>1H</b>  <b>1A</b> 	<b>03</b> grey <b>09</b> black  <u>Colour code 1A</u> <b>16</b> frosted white	<b>1</b> transparent <b>2</b> green <b>4</b> yellow <b>6</b> frosted white <b>8</b> red

\*For an illuminated quiet 2.0N switch add Q to the end of the switch part number.

### NON-ILLUMINATED – HOW TO ORDER

Switch	Mounting	Actuation force	+	Cap	Colour code 1A/1M	Colours 1ZA:
<b>5 G</b>	<input type="checkbox"/> <input type="checkbox"/> <input type="checkbox"/>	<input type="checkbox"/> <input type="checkbox"/> <input type="checkbox"/>		<input type="checkbox"/> <input type="checkbox"/> <input type="checkbox"/> <input type="checkbox"/>	<input type="checkbox"/> <input type="checkbox"/>	
	<b>TH9</b> through-hole <b>SH9</b> surface mount	<b>20</b> <b>20Q</b> <b>35</b> <b>65</b>		<b>1A</b>  <b>1ZA</b>  <b>1M</b> 	<b>00</b> blue <b>02</b> green <b>03</b> grey <b>04</b> yellow <b>06</b> white <b>08</b> red <b>09</b> black	<b>03</b> grey <b>06</b> white <b>09</b> black <b>30</b> ultra blue <b>40</b> dusty blue <b>42</b> aqua blue <b>50</b> metal dark blue <b>53</b> metal light grey <b>57</b> metal dark grey <b>58</b> metal bordeaux

Ordering example:

5GSH93582 + 1H098 with illumination OR 5GTH965 + 1ZA57 without illumination OR \*5GTH92001Q (illuminated quiet version).

Please see colour codes, updates of products and changes of specifications on [www.mec.dk](http://www.mec.dk)

# Legends

Available for Multimec caps

standard legends

LEGEND	1B09U_ 1B09D_	1DS09_	1FS096R_	1ZB09D_ 1ZB16DLMH_	1ZCS_	10R_ & 10RF_ 10RM16_	10Q_ 10QM16_
0	000	000	000				
1	001	001	001				
2	002	002	002				
3	003	003	003				
4	004	004	004				
5	005	005	005				
6	006	006	006				
7	007	007	007				
8	008	008	008				
9	009	009	009				
#		107	107				
*		019	019				
→		033					
←		133					
↑		034					
↓		134					
↶		135	135				
+						054	054
-						059	059
▲				136*			
⏻		123	123		123*	123	123
ON/OFF						017	017
STOP						018	018
START						031	031
RESET					038	038	038
CANCEL						048	048
ENTER					105	105	105
ESC					051		
OK					118*	118	118
SET					119		
MENU					120		
FUNC					121		
HOME					122		

## STANDARD OPTIONS

1B  
pad printed

1DS  
pad printed

1FS  
reverse printed

1ZB  
pad printed  
\*laser marked

1ZCS  
pad printed  
\*reverse printed  
\*laser marked

10R(F) & 10Q  
pad printed  
reverse printed

10RM & 10QM  
metal symbol

# Legends

Available for Multimec caps

how to order

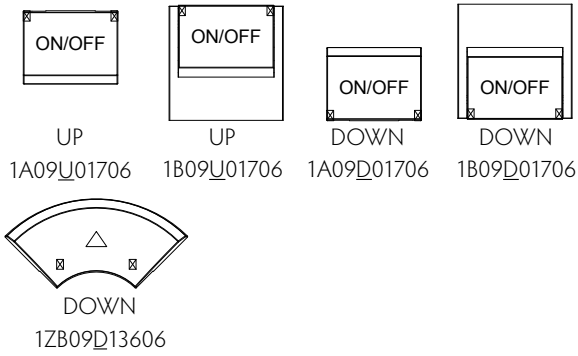

## POSITIONING OF LEGENDS ON ROCKER-ACTION CAPS

When ordering legends for caps with hinge-type cap retention system, it is important to note the position of the cap. An extra letter (U or D) needs to be added to the part number to refer to the position of the hinges in relation to the legend. See samples to the left.

Rocker-action caps without a lens: 1A, 1B, 1M, 1ZA and 1ZB

Orientation of the switch:

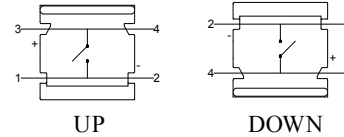

## LEGEND ILLUMINATION

Option 1: LASER MARKED

In case of laser marked legends an "LM" is added after the cap colour, before the legend code. We recommend using hard paint (additional "H" ) for increased lifetime of the paint. E.g. 1ZB16DLMH13609

Option 2: REVERSE PRINTED

In case of reverse printed caps an "R" is added after the cap colour, before the legend code. Especially relevant when standard legends has both negative and positive print option. E.g. 1FS096R00009

Option 3: METAL SYMBOL

Only available for 10RM and 10QM (therefore the "M"). E.g. 10RM16059

## STANDARD AND CUSTOM LEGENDS - HOW TO ORDER

### STANDARD LEGENDS

- Standard are only certain legends on certain caps. See the table on the previous page.
- All standard pad-printed legends are white on black caps.
- All standard reverse-printed and laser marked legends are black on frosted white cap.

Cap	Cap colour	Direction*	Type*	Legend	Legend colour*
□□□□	□□	□□	□□□□	□□□□	□□
<b>1B</b>	<b>00</b> blue	<b>D</b> down	<b>LM</b> laser marked on soft paint	<b>001</b> 1	<b>00</b> blue
<b>1DS</b>	<b>02</b> green	<b>U</b> up	<b>LMH</b> laser marked on hard paint	<b>002</b> 2	<b>02</b> green
... etc	<b>03</b> grey		<b>R</b> reverse printed	<b>003</b> 3	<b>03</b> grey
	<b>04</b> yellow	*only for hinge-type caps	*in case of illumination	... etc	<b>04</b> yellow
	<b>06</b> white				<b>06</b> white
	<b>08</b> red				<b>08</b> red
	<b>09</b> black				<b>09</b> black
	<b>16</b> frosted white				... etc
	... etc				

\*in case of laser marked legends the colour of the soft or hard paint

## NOTE:

- The size of the legends listed may not correspond to the actual size.
- If you decide to use one of the standard legends without any adjustments (without a new cliché) on another cap than designated in the table, then there is no start-up cost, for this to apply the cap has to be black and the print white.
- Standard legend colours are white paint on a black cap and black paint on a frosted white cap. Other colour combinations are handled as custom.
- For further information on legends please contact your local distributor or MEC.

PLEASE FIND THE FULL LIST OF AVAILABLE LEGENDS ON MEC WEBSITE [www.apem.com](http://www.apem.com)

Ordering example: 1ZW0913611806; 1B06U13508; 10R16R10509























Please see colour codes, updates of products and changes of specifications on [www.apem.com](http://www.apem.com)

No.	00		02		03		04		06		08		09	
Colour	blue		green		grey		yellow		white		red		black	
RAL Code	5012		6018		7004		1023		9010		3000		9004	

No.	30		32		33		34		38		40		42	
Colour	ultra blue		mint green		tele grey		melon		noble red		dusty blue		aqua blue	
RAL Code	5002		6029		7046		1028		3002		5014		5021	

## Metallic Colours

No.	50		53		57		58	
Colour	dark blue		light grey		dark grey		bordeaux	
RAL Code	No Ral Code		No Ral Code		No Ral Code		No Ral Code	

CAP CODE		00	02	03	04	06	08	09	30	32	33	34	38	40	42	50	53	57	58
1A		•	•	•	•	•	•	•											
1B		•	•	•	•	•	•	•											
1C				•			•	•											
1DS		•	•	•	•	•	•	•	•	•	•	•	•	•	•	•	•	•	•
1ES/1FS		•	•	•	•	•	•	•											
1GAS/1GCS		•	•	•	•	•	•	•											
1H				•				•											
1JS		•	•	•	•	•	•	•											
1KS		•	•	•	•	•	•	•											
1M		•	•	•	•	•	•	•											
1NS				•				•											
1PS		•	•	•	•	•	•	•											
1QS/1RS		•		•				•											
1SS/1LS		•	•	•	•	•	•	•											
1TS/1US/1VS		•		•				•	•										
1WAS/1WDS/1WPS		•		•				•	•	•				•	•		•	•	
1XS		•	•	•	•	•	•	•											
1ZA				•		•		•	•					•	•	•	•	•	•
1ZB				•		•		•	•					•	•	•	•	•	•
1ZCS				•		•		•	•					•	•	•	•	•	•
1Z/1ZW		•		•		•		•											
10R/10RF + 10Q		•	•	•	•	•	•	•											



- Through-hole (TH) or surface mount (SMD)
- 50mA/24VDC
- Single pole/momentary
- 10,000,000 operations lifetime (NO function)
- Temperature range:
  - Switch: -40/+160°C
  - LED: -40/+85°C
- IP 67 sealing
- Actuation force: 2.0N, 3.5N, 6.5N
- NO or NC/NO

All dimensions in mm

Tolerances +/-0.2mm

### THROUGH-HOLE (TH)

5G

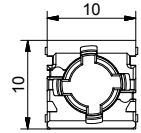
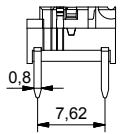
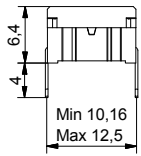

5G illuminated

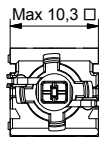
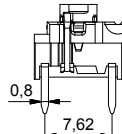
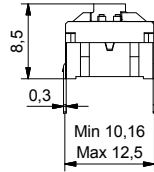

5E

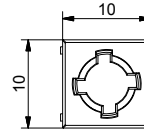
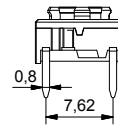
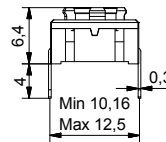

### PCB LAYOUT

Non-illuminated

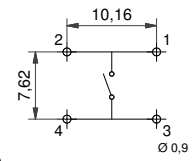

1 LED

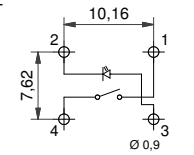

2 LED

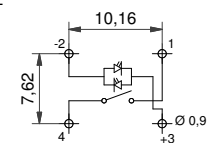

### SURFACE MOUNT (SMD)

5G

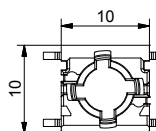
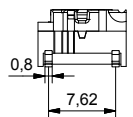
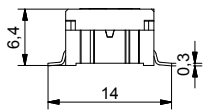

5G illuminated

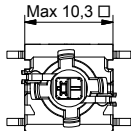
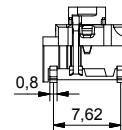
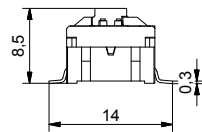

5E

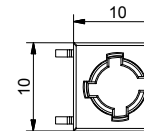
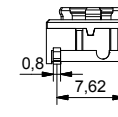
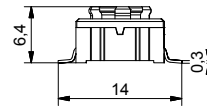

### PCB LAYOUT

Non-illuminated

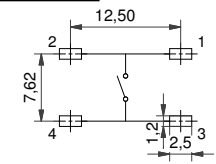

1 LED

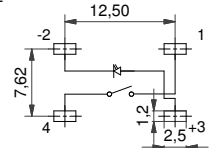

2 LED

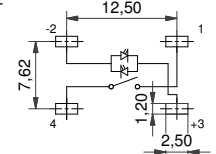

### NORMALLY CLOSED/NORMALLY OPEN FUNCTION

- Available for 5E and non-illuminated 5G in 3.5N actuation force.
- Same PCB layout as the NO 5E and 5G
- Housing colour is **grey**
- Switch point 0.7 mm +/- 0.3 mm
- Return point 0.5 mm +/- 0.3 mm

### NOT FOR SALE IN JAPAN

### CIRCUIT DIAGRAM

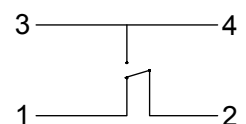

### RIGHT ANGLE SWITCHES

### PCB LAYOUT

5E

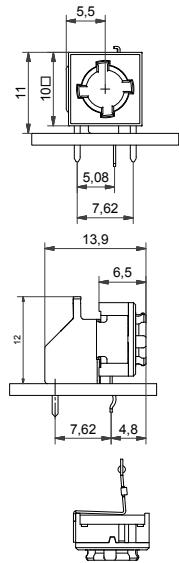

5G

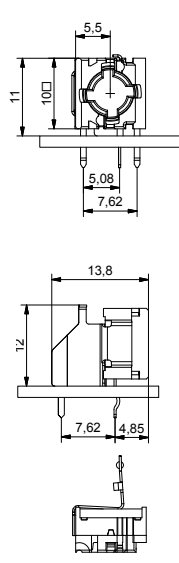

5G + 1SS

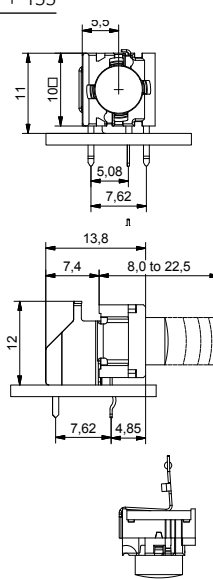

5G + 1DS

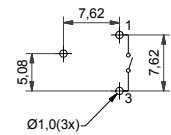
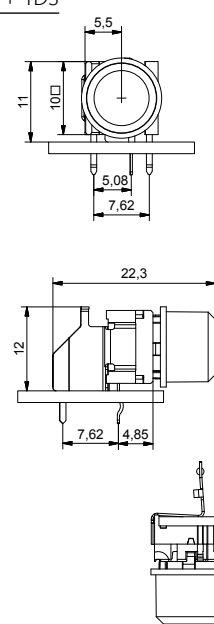

multimec® 5 series has only normally open (NO) non-illuminated right angle switch.

### ILLUMINATED – HOW TO ORDER

Switch	Mounting	Actuation force	LED	Quiet (optional)
<b>5 G</b>	<input type="checkbox"/> <input type="checkbox"/> <input type="checkbox"/>	<input type="checkbox"/> <input type="checkbox"/> <input type="checkbox"/>	<input type="checkbox"/> <input type="checkbox"/> <input type="checkbox"/>	<input type="checkbox"/>
	<b>TH9</b> through-hole <b>SH9</b> surface mount	<b>20</b> <b>35</b> <b>65</b>	<b>02</b> blue <b>22</b> green <b>42</b> yellow <b>61</b> white	<b>Q</b> only for 2.0N
			<b>82</b> red <b>2242</b> green/yellow <b>8222</b> red/green <b>8242</b> red/yellow	

### NON-ILLUMINATED – HOW TO ORDER

Switch	Mounting	Actuation force	RAS (optional)	or	NC/NO (only for 3.5N)
<b>5 E</b>	<input type="checkbox"/> <input type="checkbox"/> <input type="checkbox"/>	<input type="checkbox"/> <input type="checkbox"/> <input type="checkbox"/>	<input type="checkbox"/> <input type="checkbox"/> <input type="checkbox"/>	<input type="checkbox"/> <input type="checkbox"/> <input type="checkbox"/>	<input type="checkbox"/> <input type="checkbox"/> <input type="checkbox"/> <input type="checkbox"/>
	<b>TH9</b> through-hole <b>SH9</b> surface mount	<b>20</b> <b>20Q</b> <b>35</b> <b>65</b>	<b>RAS</b> right angle switch		<b>NCNO</b> normally closed/ normally open function

Switch	Mounting	Actuation force	RAS (optional)	or	NC/NO (only for 3.5N)
<b>5 G</b>	<input type="checkbox"/> <input type="checkbox"/> <input type="checkbox"/>	<input type="checkbox"/> <input type="checkbox"/> <input type="checkbox"/>	<input type="checkbox"/> <input type="checkbox"/> <input type="checkbox"/>	<input type="checkbox"/> <input type="checkbox"/> <input type="checkbox"/>	<input type="checkbox"/> <input type="checkbox"/> <input type="checkbox"/> <input type="checkbox"/>
	<b>TH9</b> through-hole <b>SH9</b> surface mount	<b>20</b> <b>20Q</b> <b>35</b> <b>65</b>	<b>RAS</b> right angle switch		<b>NCNO</b> normally closed/ normally open function

Ordering example: 5ESH935 (non-illuminated), 5GTH9658222 (illuminated), 5GSH935NCNO (normally closed/normally open); 5ETH920RAS (right angle) 5ETH920Q or 5GSH92061Q (quiet versions)

Please see colour codes, updates of products and changes of specifications on [www.apem.com](http://www.apem.com)

### Basic switch spacing

through-hole (TH)

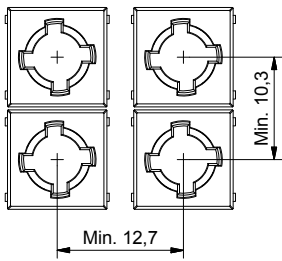

surface mount (SMD)

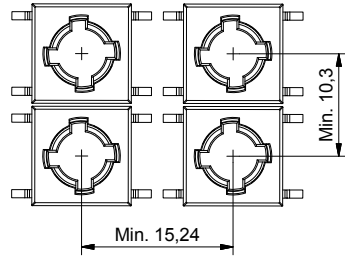

### Recommended switch/cap spacing

Switch spacing

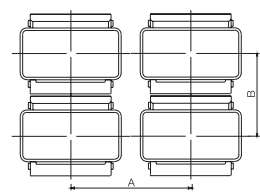

Cap dimensions

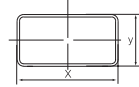

Panel cut-out

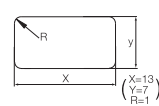

### Panel cut-out

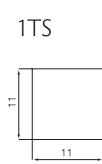
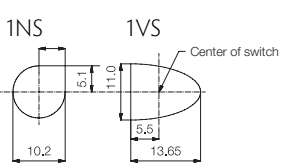

### Spacing examples

multimec  
5GT+1B/C+2C/D

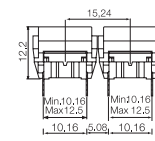

multimec  
5GS+1B/C+2C/D

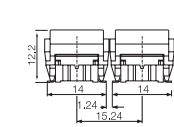

multimec  
5GT + 1A/H

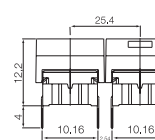

multimec  
5GT + 1M

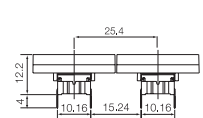

multimec  
1NS + 1NS + 1NS

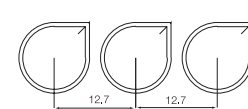

multimec  
1VS + 1TS+ 1VS

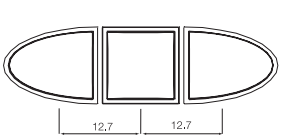

Cap series	Recommended min. switch spacing AxB	Nominal cap dimension WxH	Recommended min. panel cut-out
1A/1H	12.7x10.16	12.6x10.1	13.0x10.5
1B/1C+2C/2D	15.24x15.24	15.1x15.1	15.5x15.5
1DS/1ES/1FS	12.7x12.7	ø9.6	ø10.0
1GAS	12.7x11.14	ø11	ø11.4
1GCS	15.14x15.14	ø15	ø15.4
1JS	12.7x12.7	ø9.6	ø10.4
1KS/1KBS/1KCS	15.24x15.24	14.3x14.3	14.7x14.7
1M	25.4x10.16	25.0x10.	25.7x10.5
1NS	12.7x12.7	ø9.8/□4.9	ø10.2/□5.1
1PS/1QS/1RS	15.24x10.16	6.5x12.5	7.0x13.0, R max. 1.0
1SS/1IS/1LS	12.7x12.7	ø6.5	ø7.0
1TS	12.7x12.7	10.6x10.6	11.0x11.0
1US	12.7x12.7	ø10.6	ø11.0
1VS	12.7x12.7	10.6x13.25	11.0x13.65
1WAS/1WPS	12.7x10.3	12.5x6.5	12.9x6.9
1WDS	15.34x10.3	15.2x8.0	15.6x8.4
1XS	12.7x12.7	9.4x7.4	9.8x7.9
1YS	17x17	15x15	16x16
1ZA	18.84x10.3	18.7x10.1	19.4x10.5
1ZB	24.34x12.1	R1=7.4; R2=17.5 90°	R1=7.1; R2=17.5-17.75 90°
1ZCS	14.44x14.44	ø14.3	ø14.7
1Z/1ZW	35.5x35.5; 41.6x41.6	ø29.5	ø30.3
10R/10RF/10RM	40.5x40.5	ø30.0	ø30.6
10Q/10QM	32.5x32.5	22x22	22.5x22.5

## Tape & Reel

Tape and reel is available for the parts listed and has the following specifications:

Reel diameter:	Ø330mm	Tape and reel material:	antistatic or better
Tape width:	24mm	Quantity per reel:	see list
Pitch:	see list		

### 3C/3E/5E/5G multimec<sup>®</sup> tape & reel

Part No.	Ordering Code	Pitch	Quantity per reel
3CSH9	3CSH9R	16	500
3ESH9	3ESH9R	16	500
5ESH9XX	5ESH9XXR	16	500
5GSH9XX	5GSH9XXR	16	500
5XSH9XX1SSXX-08.0	5XSH9XXR1SSXX-08.0	20	250
5XSH9XX1SSXX-09.5	5XSH9XXR1SSXX-09.5	20	250
5XSH9XX1SSXX-10.4	5XSH9XXR1SSXX-10.4	20	250
5XSH9XX1SSXX-11.0	5XSH9XXR1SSXX-11.0	20	250
5XSH9XX1SSXX-12.0	5XSH9XXR1SSXX-12.0	20	250
All varimec h <12.5; add R after part no.			20 250

### illuminated 5G multimec<sup>®</sup> tape & reel

Part No.	Ordering Code	Pitch	Quantity per reel
5GSH9XX02	5GSH9XX02R	20	250
5GSH9XX22	5GSH9XX22R	20	250
5GSH9XX42	5GSH9XX42R	20	250
5GSH9XX61	5GSH9XX61R	20	250
5GSH9XX82	5GSH9XX82R	20	250
5GSH9XX2242	5GSH9XX2242R	20	250
5GSH9XX8222	5GSH9XX8222R	20	250
5GSH9XX8242	5GSH9XX8242R	20	250

## How to assemble

multimec<sup>®</sup>  
5GS+1A/H

multimec<sup>®</sup>  
5GS+1B/C+2C/D

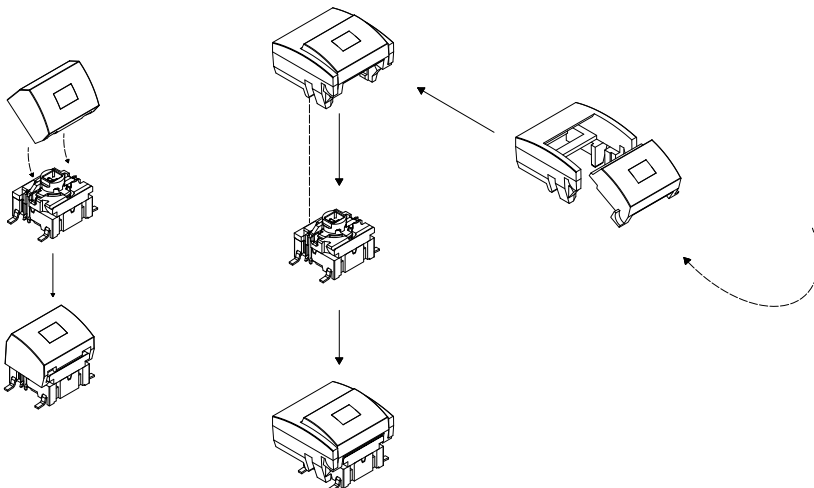

## Operating force

(typical example)

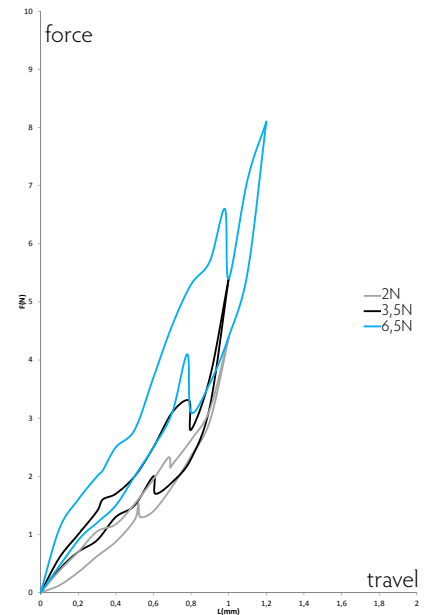

## Mounting tool for multimec<sup>®</sup> through-hole switches

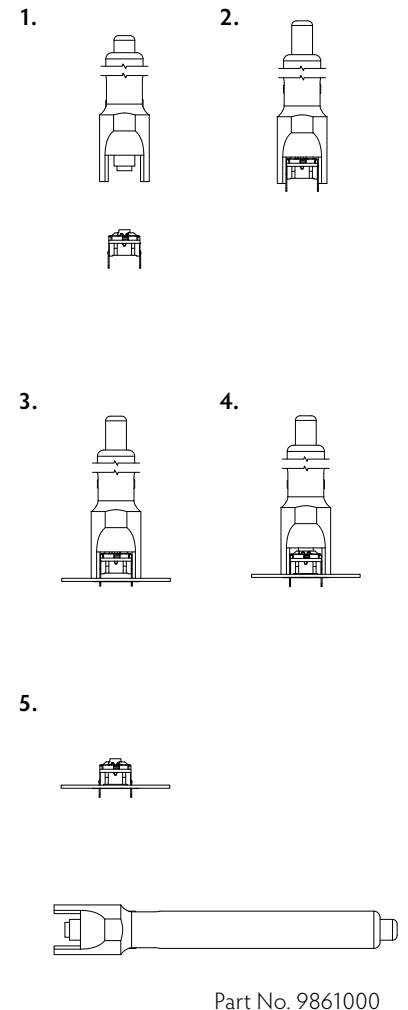



## RoHS Compatible

	HIGH TEMPERATURE VERSIONS		
	SILVER	GOLD	NC/NO
<b>ELECTRICAL SPECIFICATIONS</b>			
Contact resistance	<30m Ω - typ. 10m Ω		
Insulation resistance	>10M Ω		
Recommended load	0.5-50mA 24VDC	0.5μ-50mA 24VDC	
Contact bounce	<2mS - typically 0.5mS		
<b>MECHANICAL SPECIFICATIONS</b>			
Standard actuation force (switch)	2.0N, 3.5N, 6.5 N		3.5N
Max. Actuation force without cap	115N for 60 sec	(according to MIL-PRF-22885H)	100N for 10 sec
Key travel (switch)	1 mm		
Life time (switch)	>10,000,000 cycles		>1,000,000 cycles
<b>TEMPERATURE RANGE</b>			
Working temperature	Min -40°C Max +160°C		
Storage temperature	Min -40°C Max +160°C		
5G with LED (working & storage temp)	Min -30°C Max +85°C		
Soldering (through-hole switch)	IEC 60068-2-20 8:		
	Infrared, vapour phase, wave - max 240°C for max 40 sec or max 260°C for max 30 sec.		
	Soldering iron - max 350°C for max 3 sec.		
	Flux tight.		
<b>SOLDERING (SMD)</b>	JEDEC J-STD-020E		
<b>ENVIRONMENTAL ENDURANCE IEC 68-2-3</b>			
Temperature	+40°C		
Humidity	93% RH		
Duration	56 Days		
<b>TEMPERATURE CYCLING IEC 68-2-14</b>			
Temperature limit	Min -55°C - Max +85°C		
Number of cycles	200		
Exposure time at each temperature	10 min		
Recovery time before measurements	16 hrs		
Sealing IEC 529	IP-67		
Cleaning	Standard methods - see usage guidelines		
<b>MATERIAL SPECIFICATIONS - SWITCHES</b>			
Housing	PPS UL94V0		
Actuator	PPS UL94V0		
Sealing + spring	Silicone rubber		
Contact spring	Stainless steel		Stainless steel
	+ 3μAg		+ 1μAu
Fixed contacts	SnCu + 2μNI + 3μAg	SnCu + 2μNI + 1μAu	
Terminals	SnCu + 2μNI + 3μSn100		

## Caps, Bezels & Legends – Material Specifications

MATERIAL	PARTS	TEMP. LIMIT	UL RATING
ABS	1A, 1B, 1C, 1DS, 1ES, 1FS, 1H, 1JS, 1KS, 1LS, 1M, 1NS, 1PS, 1QS, 1RS, 1TS, 1US, 1VS, 1WAS, 1WDS, 1WPS, 1XS, 1Z, 1ZA, 1ZB, 1ZCS, 1ZW, 2C, 2D, 2K, reflectors for 1KBS/1KCS and 1YS	Max. 65°C	UL94HB
Polycarbonate	All lenses and transparent colour caps, lids for 1KBS/1KCS	Max. 85°C	UL94HB
Polyamide	1GAS/1GCS, 1SS, 2SS	Max. 160°C	UL94V2
Legends Adhesion	DS/EN ISO 2409 Class 1 & ASTM D3359 Class 4B		

### LEDs specifications

#### 5G switches

Colour		Blue	Green	Yellow	White	Red	High Intensity Green	
Colour Codes		02	22	42	61	82	29	
<b>ABSOLUTE MAXIMUM RATINGS (Ta=25°C)</b>								
Power	mW	95	75	60	48	65	102.5	
Current forward	mA	25	30	25	15	25	25	
Forward peak current	mA	100	80	60	100	100	150	
Voltage reverse	V	5	5	5	NA	12	5	
Operating temperature	°C	-40/+85	-55/+85	-40/+85	-40/+85	-30/+85	-40/+85	
Storage temperature	°C	-40/+90	-55/+85	-40/+90	-40/+85	-40/+85	-40/+85	
Soldering temperature	°C	245 for max. 10 sec						
<b>ELECTRICAL-OPTICAL CHARACTERISTICS (Ta=25°C)</b>								
Voltage forward	Typ. V	3.3	2	1.75**	2.85	2	3.3	
	Max. V	3.7	2.4	2.35	3.1	2.5	4.1	
Current reverse (VR=5V)	Max. µA	50	100	10	NA	100	50	
Wave length	nm	470	571	591	NA	633	525	
Spread	Δnm	25	NA	15	NA	16	30	
Spread angle	degree	120	130	120	150	160	60	
<b>Luminous Intensity</b>	Min. mcd	45	18	28.5	71	28	500	
	Typ. mcd	112*	35	72*	224*	180*	1000	
Optical intensity	Lm/w	NA	NA	NA	36	7	NA	

\*Max.mcd \*\*Min. V

#### 3F switches

#### 3FXXX (for 1E-1F-1N-1Q-1R-1S-1X)

#### 3FXXX (for 1K-1T-1U-1V-1W-1WD)

Colour		B	G	Y	W	R	G/Y	R/G	R/Y	G	Y	R
Colour Codes		00	20	40	65	80	2040	8020	8040	24	46	87
<b>Absolute Maximum Ratings</b>	(Ta=25°C)											
Power	mW	105	70	60	120	60	120	100	120	60	60	120
Current forward	mA	30	20	20	25	20	25	30	25	25	25	50
Forward peak current	mA	150	60**	60**	100	60**	150	120	150	60	60	200
Voltage reverse	V	5	3	3	5	3	5	5	5	5	5	5
Operating temperature	°C	-40/+85			-40/+85	-25/+85	-40/+85	-55/+100	-40/+85	-40/+85	-40/+85	-40/+85
Storage temperature	°C	-40/+85			-40/+100	-30/+100	-40/+85	-55/+100	-40/+85	-40/+85	-40/+100	-40/+100
Soldering temperature	°C	260 for max 5 sec					260 for max 2 sec			300 for max 3 sec	260 for max 5 sec	
<b>Electrical-Optical Characteristics (Ta=25°C)</b>												
Voltage forward	Typ. V	3.8	2.1	2.1	3.8	2.0	2.1	2.0	2.1	2.0*	2.0	2.0***
	Max. V	4.5	3.0	3.0	4.3	3.0	2.8	2.6	2.8	2.4*	2.4	2.4***
Current reverse (VR=5V)	µA	10	10	10	50	10	2	2	2	10	10	10
Wave length	nm	466	563	585	NA	650	565/590	630/565	625/590	570	589	624/632
Spread	Δnm	60	40	40	NA	40	35	35	35	10	NA	20
Spread angle	degree	60	45	45	25	45	60	200	60	100	40	40
<b>Luminous Intensity</b>	Min. mcd	18	9.0	5.6	630	5.6	8	2.2	8	70****	630	400****
	Typ. mcd	50	25	16	1000	16	25	4.8	25	20****	1250	800****
Orientation	The longer pin is the anode, the shorter is the cathode. For bicolour LEDs the anode for the first colour (ex. 2080) is the longer pin.											

\*\*Pulse width 1ms Duty cycle 1:5, \*\*\*/F =50mA, \*\*\*\* Luminous Flux mlm

B=Blue, G=Green, Y=Yellow, R=Red, W=White

Specifications are subject to change without notice.

Specifications are subject to change without notice.

For product updates and/or changes of specifications please see [www.apem.com](http://www.apem.com)

# Usage guidelines

## How to get the best results with MEC Switches?

These guidelines are offered to users of MEC Switches as an aid to ensure successful and reliable switch operation.

### Temperature

Both unimec™ and multimec® switches are produced in low and high temperature versions. Please see the technical specifications for details on operating and storage temperatures and soldering guidelines to make sure you select the best switch for your application. When wave soldering is taking place, MEC strongly recommend that the temperature profile is analysed and compared with the temperature rating of the switch. In case of doubt always select the high temperature versions unimec™ 154XX, and multimec® 5XXH9XX. It is also important to monitor the accumulated heat build up from both the pre-heat zones and the solder zone.

Most standard accessories for both unimec™ and multimec® switches are made from ABS plastic with a maximum operating temperature of 65°C. It is strongly recommended that accessories are mounted after soldering of the switch. If this is not possible care must be taken not to overheat the accessories during the soldering process. The 1SS, 1GAS/1GCS and Varimec™ caps are, however, made of high temperature materials and will meet the same temperature specifications as the high temperature switches.

For accessories made from other plastic materials please see multimec® and unimec™ technical specifications.

LEDs have their own temperature specifications. When fitted in a high temperature switch the LED will determine the max. operating temperature, i.e. 5GTH93524 has an upper temperature limit of 85°C! This also applies with 3F switches.

### Mounting and Dismounting

If switches are to be mounted in rows it is essential that the recommendations regarding spacing are followed. PC board thickness should be 1.4±0.2 mm and terminal hole diameter should be 0.9mm.

All unimec™ and multimec® caps and bezels are easily snapped onto the switch modules and can be changed at a later time with the exception of the unimec 16.700 cap. The same applies to the 3E caps. Once these caps are installed they are not designed to be removed. To do so may cause damage to the switch and the PC board if not done very carefully. If the 16.300 or 16.700 cap must be removed from a unimec™ alternate action switch, make sure that the switch actuator is in the released, upper position before attempting to remove the cap. This will prevent possible damage to the internal latching pin.

Care must be taken when inserting the 3FT switch and LED assembly into the PC board. Do not press direct on the LED. This will force the LED down into the actuator and risks to cause the switch contacts to remain in the closed position. To correct the fault, the LED must be raised slightly and centered in the actuator to assure unrestricted movement of the actuator. A mounting tool is available for multimec® switches.

### Soldering and Cleaning unimec™

Most assembly and field problems experienced by users of unsealed switches are caused by the contamination of the contacts during soldering and cleaning.

Contact contamination may be recognised by an increase in contact resistance and possible intermittent operation of the switch, especially in low power applications. Care must be taken not to submerge the switch in cleaning agents or spray the switch during cleaning. The switch must be protected at all times to prevent contamination by flux or cleaning liquids.

For unimec™ alternate versions we recommend to leave the actuator in the released upper position during soldering. This makes the switch more resistant to overheating.

### Soldering and Cleaning multimec®

multimec® switches are fully sealed to IP67 specifications to prevent solder flux and aqueous based cleaning solutions from entering the switch and contaminating the contacts. The switches can be placed on the PC board with other components and wave soldered. multimec® offers a high level of sealing, however, with aqueous solvent solutions care must be taken to avoid the worst case situation with water jets, complete immersion into a liquid with a temperature below the board or surface tension reducing additives.

Recommended cleaning methods are demineralized water. Any surface tension reducing agents, such as soap, must not be used as they risk causing a potential leakage of the switch.

### Soldering - Through Hole Versions

Hand soldering: Max. 350°C for max. 3 sec., this applies for both low temperature and high temperature versions.

Wave soldering: heat built up in the switch during pre-heating and soldering must not exceed the maximum operating temperature of the switch. If, for some reason, a high pre-heating temperature is required, MEC recommend the high temperature switches. In any case peak temperature must not exceed 260°C, and soldering time is max 10 sec.

### Soldering - Surface Mount Versions

For all methods - infrared, convection and vapour phase. The upper limit 260°C/30 sec must be observed. The soldering temperature profile must have moderate temperature gradients.

### RoHS Compliance

As of 1 July 2006 MEC has completed the conversion to RoHS compliance. For more info please see our homepage [www.apem.com](http://www.apem.com)

### Temperature Limits:

Low temperature switch	115°C
High temperature switch	160°C
LEDs	85/100°C
Accessories	65/85/160°C

### Packaging

unimec™ and multimec® switches are packed in rigid tubes of 50 pieces each.

A box contains 1.000 pcs.

The surface mount versions of multimec® switches with a height up to 12.5mm can also be delivered on tape/reel. Each reel contains 250/500 pcs.