

STRADA-SQ-T2-B

IESNA Type II (medium) beam with minimized house side backlight. Version with location pins. Assembly with installation tape.

TECHNICAL SPECIFICATIONS:

Dimensions	25 x 25 mm
Height	9.1 mm
Fastening	tape
Colour	clear
Box size	476 x 273 x 292 mm
Box weight	8.7 kg
Quantity in Box	2058 pcs
ROHS compliant	yes ⓘ



MATERIAL SPECIFICATIONS:

Component	Type	Material	Colour
STRADA-SQ-T2-B	Lens	PMMA	clear
ROSE-TAPE	Tape	PU tape	black

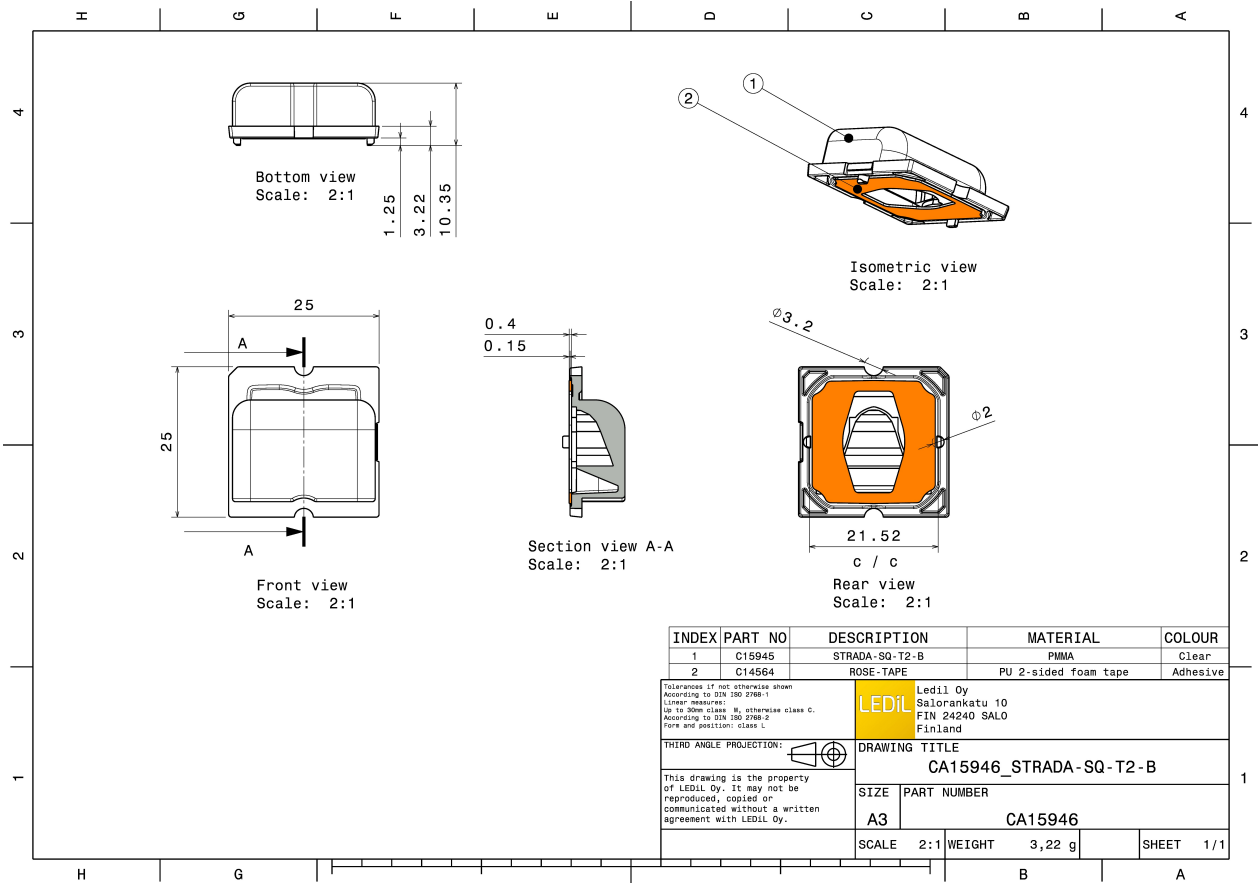

PHOTOMETRIC DATA (MEASURED):



LED LUXEON M/MX
FWHM Asymmetric
Efficiency 92 %
Peak intensity 0.700 cd/lm
Required components:

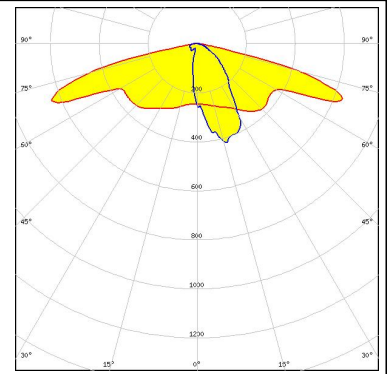

PHOTOMETRIC DATA (SIMULATED):

CITIZEN

LED PSL440
FWHM Asymmetric
Efficiency 90 %
Peak intensity 0.870 cd/lm
Required components:

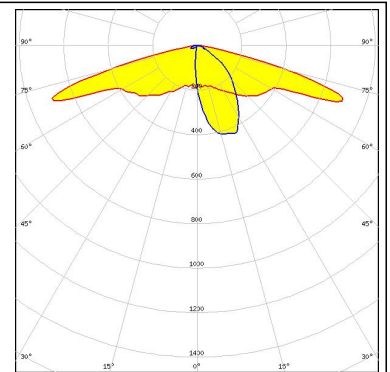

CITIZEN

LED PSL445
FWHM Asymmetric
Efficiency 88 %
Peak intensity 0.500 cd/lm
Required components:

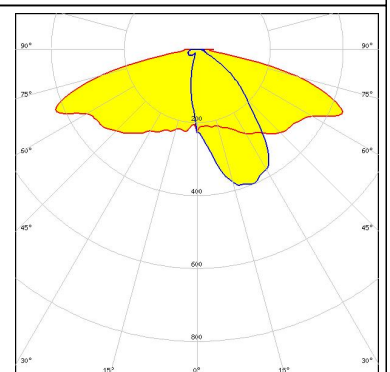

CREE

LED XHP50
FWHM Asymmetric
Efficiency 92 %
Peak intensity 0.730 cd/lm
Required components:

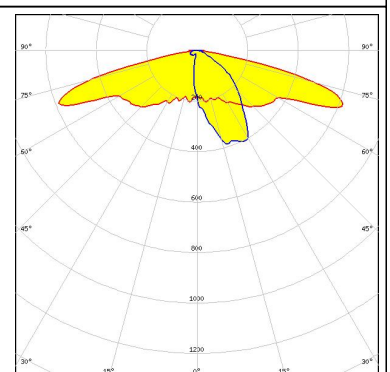

CREE

LED XP-E2
FWHM Asymmetric
Efficiency 91 %
Peak intensity 1.130 cd/lm
Required components:

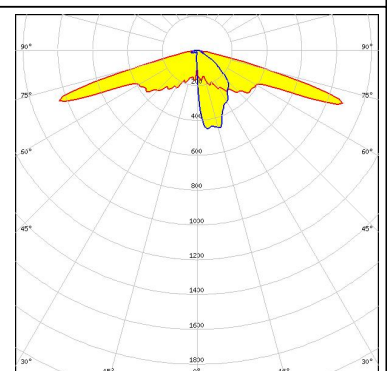

PHOTOMETRIC DATA (SIMULATED):



LED LUXEON M/MX

FWHM Asymmetric

Efficiency 76 %

Peak intensity 0.460 cd/lm

Required components:

Undefined Manufacturer: Protective Plate, Glass

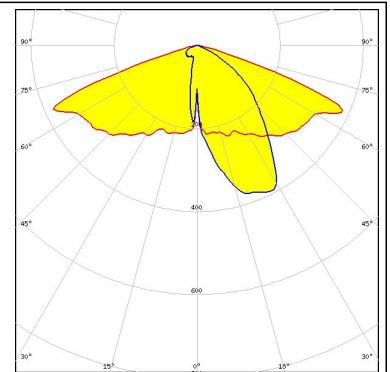

LED Duris S8

FWHM Asymmetric

Efficiency 91 %

Peak intensity 1.100 cd/lm

Required components:

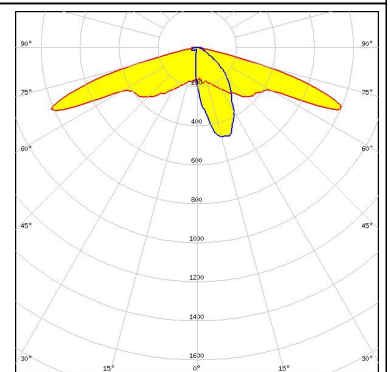

GENERAL INFORMATION:

NOTE: The typical beam angle will be changed by different color, chip size and chip position tolerance. The typical total beam angle is the full angle measured where the luminous intensity is half of the peak value.

MATERIALS:

As part of our continuous research and improvement processes, and to ensure the best possible quality and availability of our products, LEDiL reserves the right to change material grades without notice.

PRODUCT DATA USER AGREEMENT AND DISCLAIMER:

The measured data in the provided downloadable LEDiL Product Datasheets and Mechanical 2D-Drawings is rounded and provided as reference for planning. LEDiL Oy's optical specifications have been verified by conducting performance testing of the products in accordance with the company's quality system. The reported data are averaged results of multiple measurements with typical variation. LEDiL Oy reserves the right to without prior notification make changes and improvements to its products.

LEDiL Oy assumes neither warranty, nor guarantee nor any other liability of any kind for the contents and correctness of the provided data. The provided data has been generated with highest diligence but the provided data may in reality not represent the complete possible variation range of all intrinsic parameters. Therefore, in certain cases a deviation from the provided data could occur.

LEDiL Oy reserves the right to undertake technical changes of its products without further notification which could lead to changes in the provided data. LEDiL Oy assumes no liability of any kind for the possible deviation from any provided data or any other damage resulting from the usage of the provided data.

The user agrees to this disclaimer and user agreement with the download or usage of the provided files.

LEDiL Oy

Joensuunkatu 13
FI-24240 SALO
Finland

LEDiL Inc.

228 West Page Street
Suite D
Sycamore IL 60178
USA

Local sales and technical support

[www.ledil.com/
where_to_buy](http://www.ledil.com/where_to_buy)

Shipping locations

Salo, Finland
Hong Kong, China

Distribution Partners

[www.ledil.com/
where_to_buy](http://www.ledil.com/where_to_buy)