

ASSEMBLY - VIEW FROM FRONT

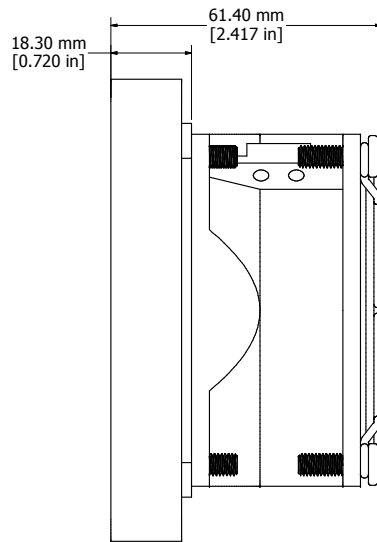

ASSEMBLY - VIEW FROM SIDE

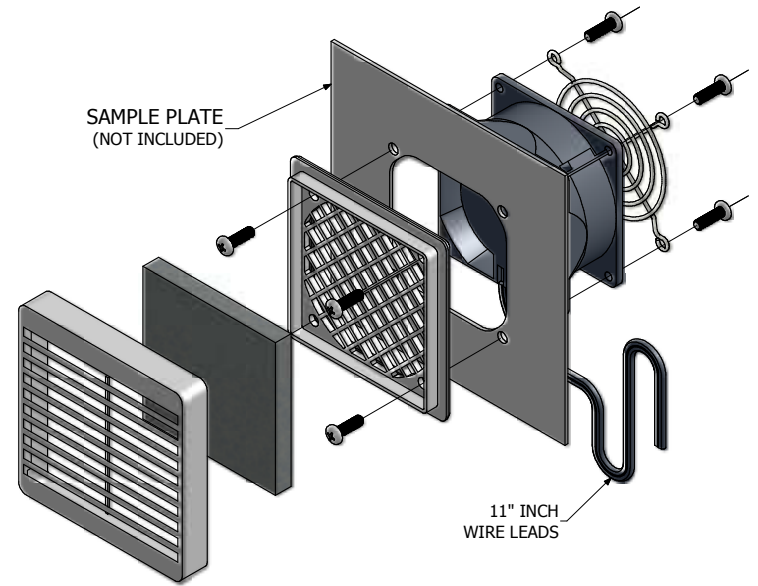

EXPLODED ISOMETRIC VIEW

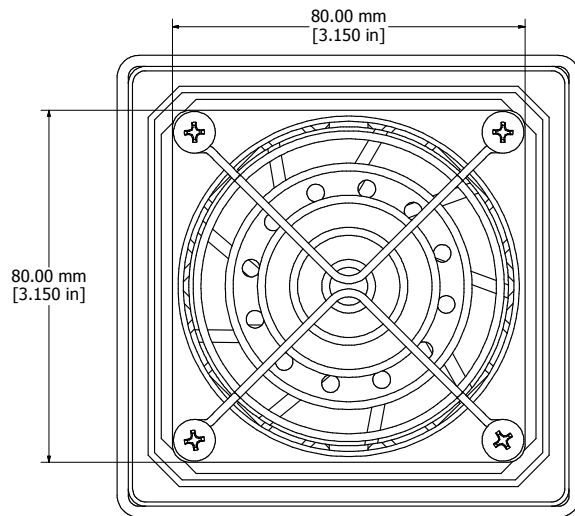

ASSEMBLY - VIEW FROM BACK

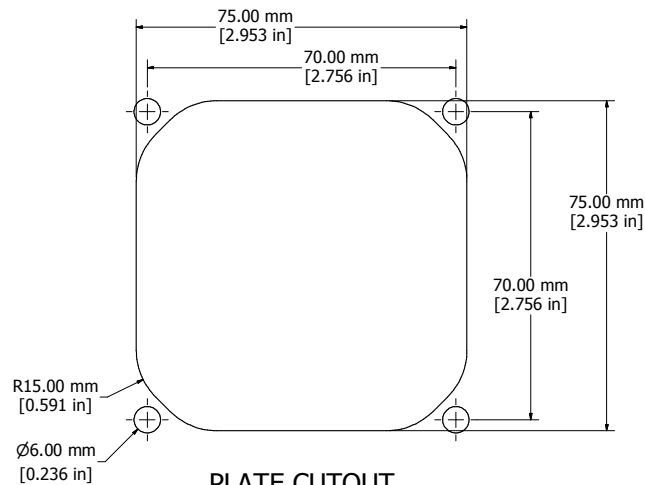

PLATE CUTOUT

DNFF080**230
Finish - Front Screen - ABS Plastic
- Back Panel - ABS Plastic
Rated - 230 VAC, 50/60 Hz, 0.05 Amps
Free Flow Air Delivery - 32 CFM
Colours
DNFF080BK230 - Black
DNFF080CG230 - Gray/Beige
DNFF080GY230 - Gray
DNFF080LG230 - Light Gray
Hardware
8 Screws - Panhead Self-tapping 10-32 x 1/2"
4 Speed Nuts

