

DATE	REV	EON	APP'D. BY
1/31/06	A1	7462	JM
2/7/06	A2	7486	JM
3-31-06	A3	7567	TRM
5-23-12	A4	9477	SMN

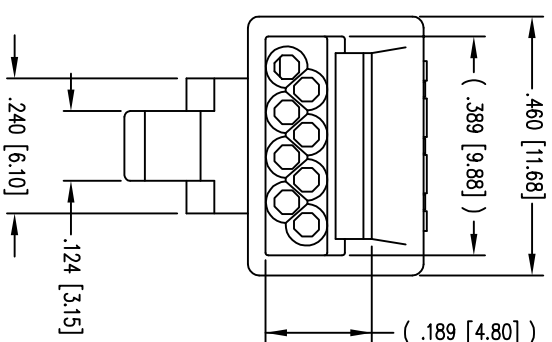
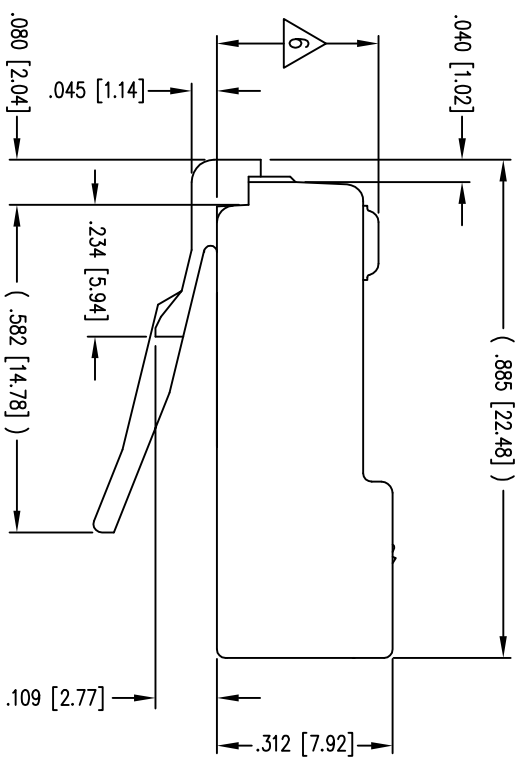
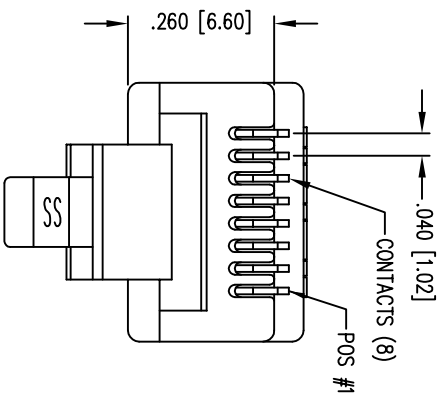
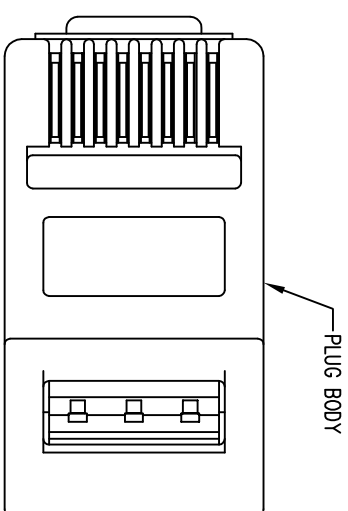

- NOTES:
- 1- PLUG KIT CONSISTS OF :  
PRE-INSERTED PLUG HOUSING  
MANAGEMENT BAR
  - 2- MATERIALS :  
FRONT HOUSING PLASTIC : CLEAR POLYCARBONATE, UL 94-V0  
MANAGEMENT BAR : CLEAR POLYCARBONATE, UL 94-V0  
CONTACTS : PHOSPHOR BRONZE, SELECTIVE GOLD PLATING
  - 3- CONTACTS TERMINATE STRANDED & SOLID CONDUCTORS UP  
TO .042 [1.07] OUTSIDE DIAMETER OF INSULATION.
  - 4- FOR PRODUCT SPECIFICATION SEE PRO26-01.
  - 5- DIMENSIONS AND TOLERANCES COMPLY WITH FCC/CFR 47, PART 68.
- ⚠ TERMINATED PLUG HEIGHT: .237 [6.02] ±.005 [0.13] ON CABLE

A

A

B

B

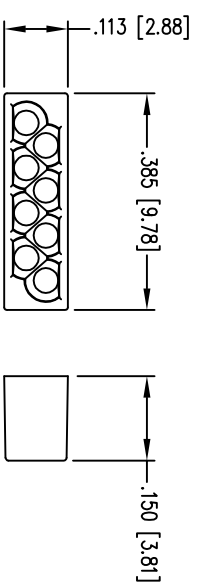

MANAGEMENT BAR  
P/N 370808M2-MB

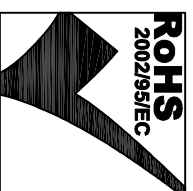

BULK	50 MICRO-INCHES [1.27um]	943-SP-370808M2
PACKAGE	CONTACT PLATING IN MATING AREA	PART NUMBER

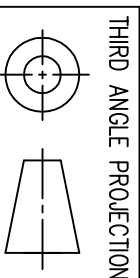

DO NOT SCALE DRAWING  
DRAWING IS SUBJECT TO  
CHANGE WITHOUT NOTICE

DIMENSIONS: INCHES [METRIC]

UNLESS OTHERWISE SPECIFIED  
TOLERANCES ARE ±.005 [0.13]  
ANGLES ARE ± 1°

SHEET NO. 1 OF 1

**Bel Stewart Connector**

11118 Susquehanna Trail South  
Glen Rock, PA 17327-9199  
(717) 235-7512 Fax: (717) 235-7954  
<http://www.stewartconnector.com>

TITLE: CAT 5 PLUG

THIS DRAWING AND THE SUBJECT MATTER SHOWN THEREON ARE  
CONFIDENTIAL, AND THE PROPRIETARY PROPERTY OF BEL STEWART CONNECTOR  
AND SHALL NOT BE REPRODUCED, COPIED, OR USED IN ANY MANNER WITHOUT  
PRIOR WRITTEN CONSENT OF BEL STEWART CONNECTOR. THIS PRODUCT  
MAY BE PROTECTED BY ONE OR MORE OF THE FOLLOWING US PATENTS:  
5628647 6402559 6409533 6524728  
7753717 8033663  
OTHER PATENTS MAY BE PENDING.

DRN BY:	R.S.	DATE	2-2-94
APPD BY:	TGM	DATE	2-2-94
DWG NO.	CT370001	REV.	A4