

Part No. 1001011

GPS/GLONASS/Beidou/Galileo FR4 Antenna (On/Off Ground)

1.561, 1.575, 1.603 GHz

Supports: Tracking, Smart Home, Agriculture, Automotive, Healthcare, Digital Signage, Wearables, Industrial Devices

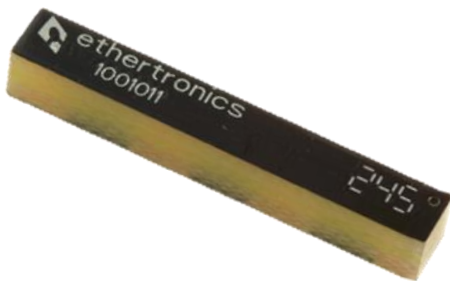

Ethertronics' antennas deliver on the key needs of device designers for higher functionality and performance in smaller/thinner designs. These innovative antennas provide compelling advantages for 1.575 GHz enabled handheld devices, media players and other mobile devices.

Real-World Performance and Implementation

Antennas may look alike on the outside, but the important difference is inside. Other antennas may contain simple PIFA or monopole designs that interact with their surroundings, complicating layout or changing performance with use position. Ethertronics' antennas utilize patented Isolated Magnetic Dipole (IMD) technology to deliver a unique size and performance combination.

Greater Flexibility

Ethertronics' IMD technology enables the advance antenna design that delivers superior performance in reception critical applications. 1001011 is capable for off-ground and on-ground (over metal) environments.

Electrical Specifications

Typical Characteristics, on 72 x 50 mm PCB

Frequency (GHz)	1.559 - 1.563	1.575	1.559 - 1.591	1.593 - 1.610
Mounting	Off Ground / On Ground			
GNSS Bands	Beidou	GPS	Galileo	Glonass
Peak Gain (dBi)	0.96 / -0.26	0.87 / -0.22	0.96 / -0.18	1.00 / -0.35
Efficiency (%)	72 / 47	71 / 46	70 / 45	69 / 41
Center Frequency f_0 (GHz)	1.561	1.575	1.575	1.603
VSWR	1.5:1 / 2.5:1			
Feed Point Impedance	50 Ω unbalanced			

Mechanical Specifications & Ordering Part Number

Ordering Part Number	1001011
Size (mm)	22.0 x 3.2 x 3.3
Mounting	Surface mounted to the PCB
Weight (grams)	0.45
Packaging	Tape & Reel
Demo Board	1001011-02

GPS / GLONASS / Beidou / Galileo FR4 Antenna

1.559 – 1.610 GHz

KEY BENEFITS

Stay-in-Tune

IMD antenna technology provides superior RF field containment, resulting in less interaction with surrounding components.

Quicker Time-to-Market

By optimizing antenna size, performance and emissions, customer and regulatory specifications are more easily met.

Reliability

Products are the latest RoHS version compliant.

APPLICATIONS

- Embedded design
- Cellular, Headsets, Tablets
- Gateway, Access Point
- Handheld
- Telematics
- Tracking
- Healthcare
- M2M, Industrial devices
- Smart Grid
- OBD-II



1.575 GHz Ethertronics' Embedded Antenna Specifications.
Ethertronics produces a wide variety of standard and custom antennas to meet user needs.

Antenna Dimensions

Typical antenna dimensions (mm)

Part Number	A (mm)	B (mm)	C (mm)
1001011	22.0 ± 0.3	3.2 ± 0.2	3.3 ± 0.3

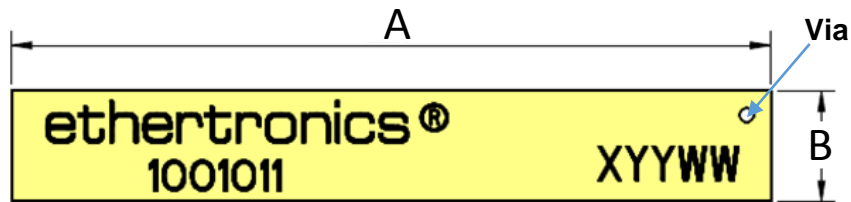
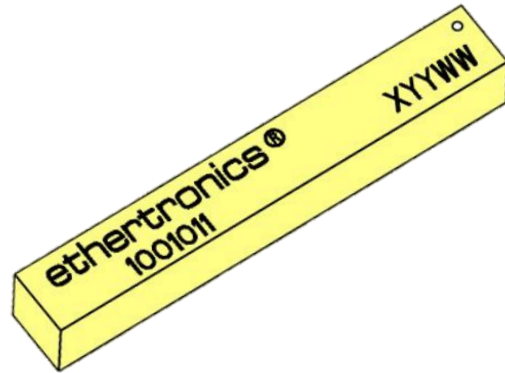

Top View

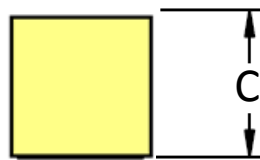

Height

Pin Descriptions

Pin#	Description
1	Feed
2	Dummy Pad
3	Dummy Pad
4	Dummy Pad

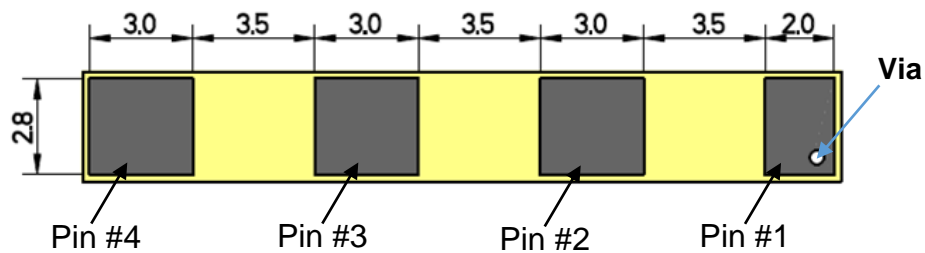

Bottom View



1.575 GHz Ethertronics' Embedded Antenna Specifications.
Ethertronics produces a wide variety of standard and custom antennas to meet user needs.

VSWR and Efficiency Plots (Off-Ground)

Typical Performances on 72 x 50 mm PCB

VSWR

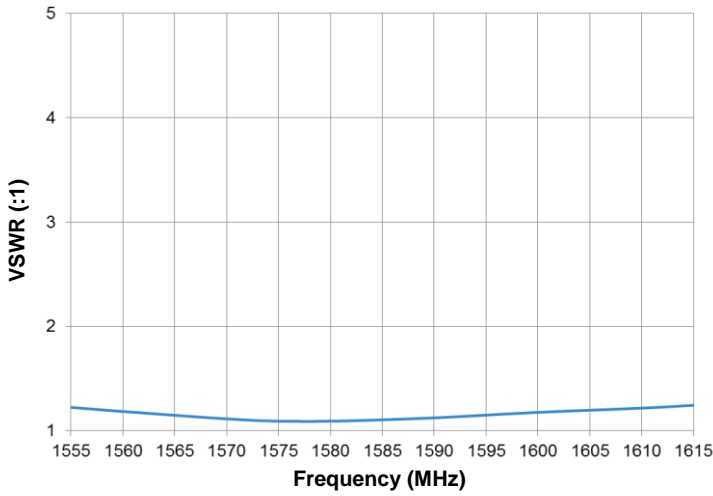

Efficiency

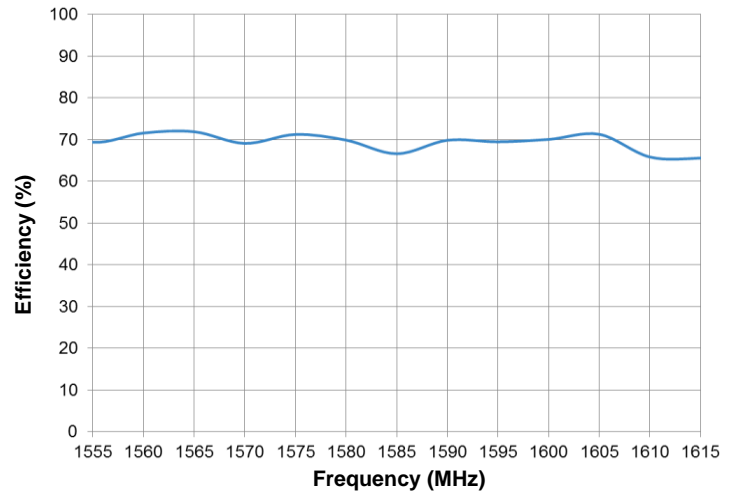

Antenna Radiation Patterns (Off-Ground)

Typical Performances on 72 x 50 mm PCB
measured @ 1.575 GHz

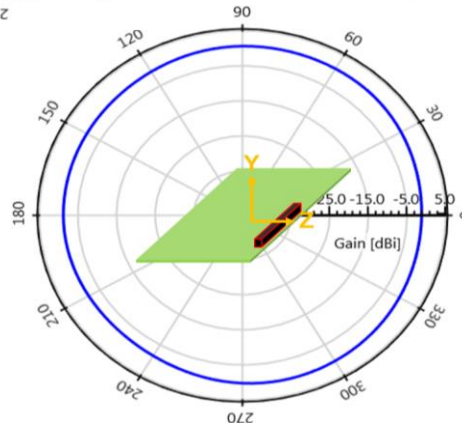
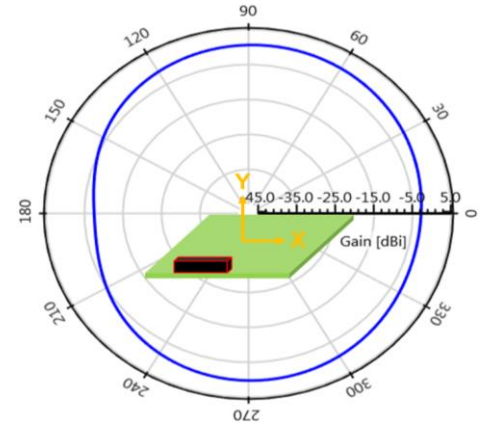
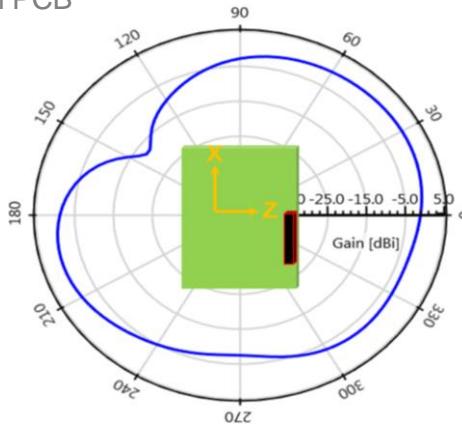



1.575 GHz Ethertronics' Embedded Antenna Specifications.
Ethertronics produces a wide variety of standard and custom antennas to meet user needs.

Antenna Layout (Off-Ground)

Typical layout dimensions (mm)

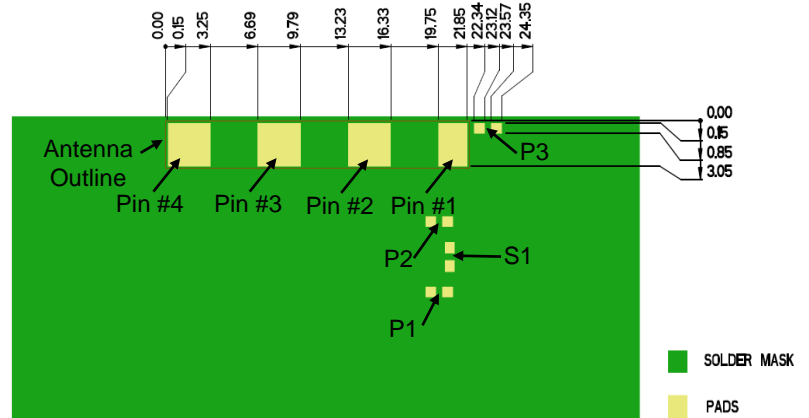
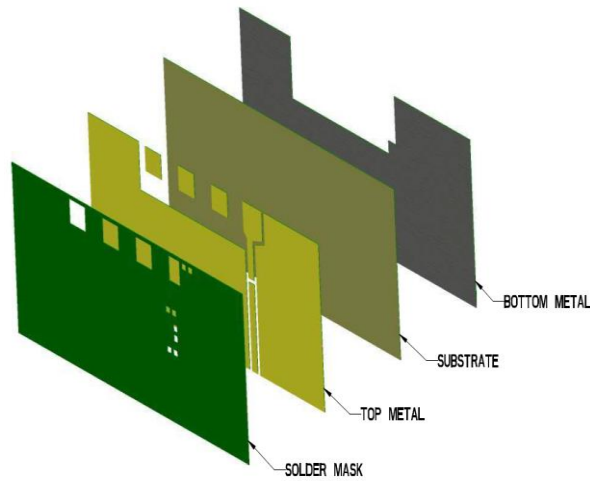

* VIAS: Diam. 0.2mm, (no vias on transmission lines).
Via holes must be covered by solder mask

Pin Descriptions

Pin#	Description
1	Feed
2	Dummy Pad
3	Dummy Pad
4	Dummy Pad

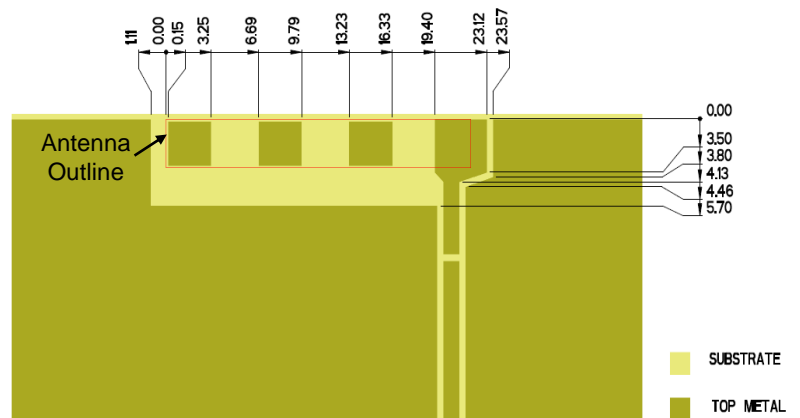

Matching Pi Network (Demo Board)

Component	Value	Tolerance
P1	DNI	N/A
S1	4.3pF	±0.25pF
P2	1pF	±0.5pF
P3	0Ω	N/A

*Actual matching values depend on customer design

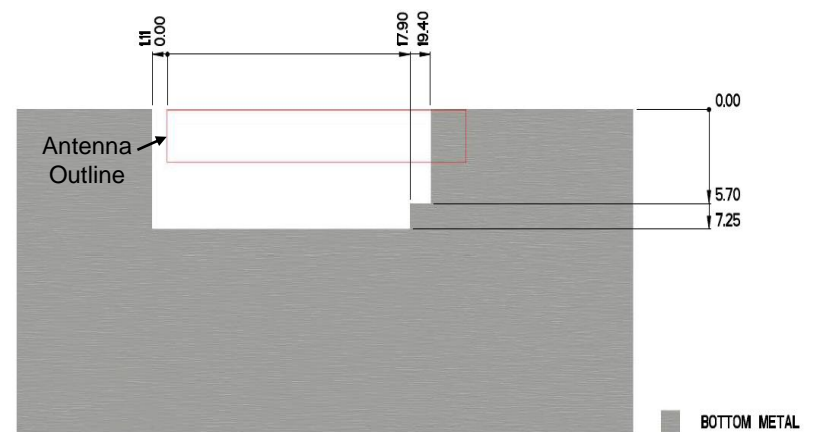
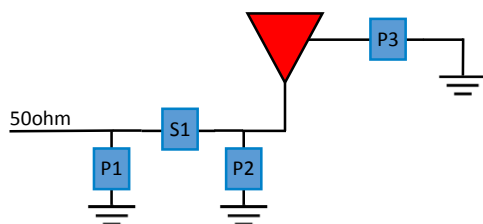



1.575 GHz Ethertronics' Embedded Antenna Specifications.
Ethertronics produces a wide variety of standard and custom antennas to meet user needs.

VSWR and Efficiency Plots (On-Ground)

Typical Performances on 72 x 50 mm PCB

VSWR

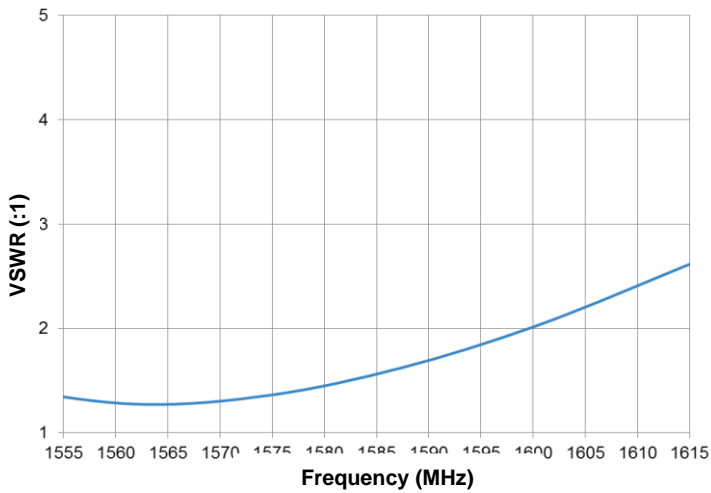

Efficiency

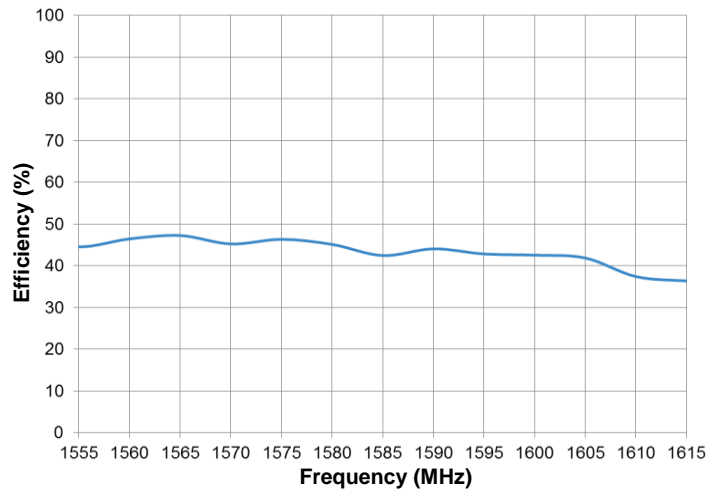

Antenna Radiation Patterns (On-Ground)

Typical Performances on 50 x 72 mm PCB
measured @ 1.575 GHz

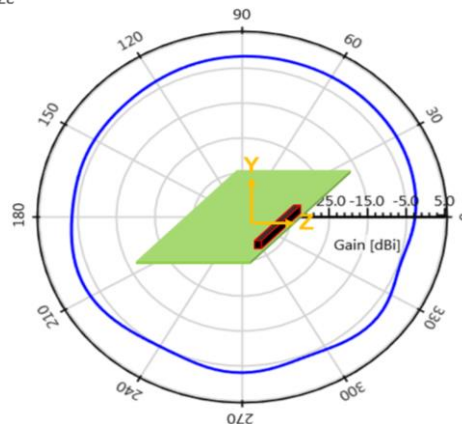
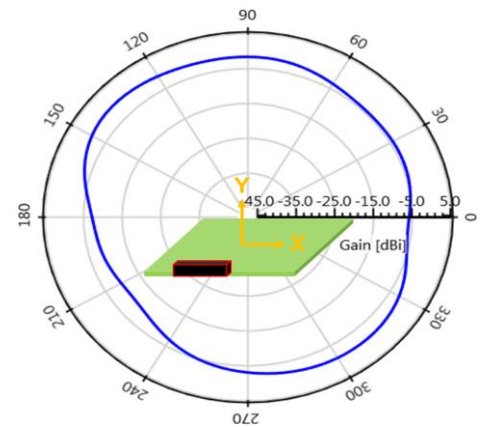
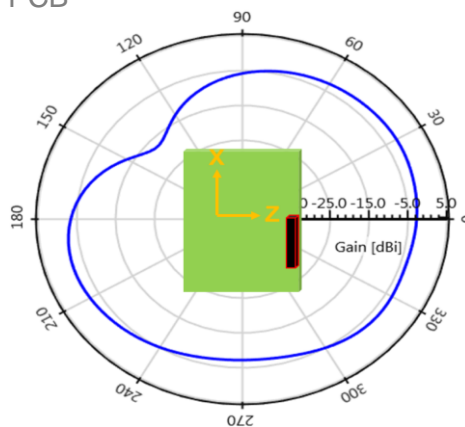



1.575 GHz Ethertronics' Embedded Antenna Specifications.
Ethertronics produces a wide variety of standard and custom antennas to meet user needs.

Antenna Layout (On-Ground)

Typical layout dimensions (mm)

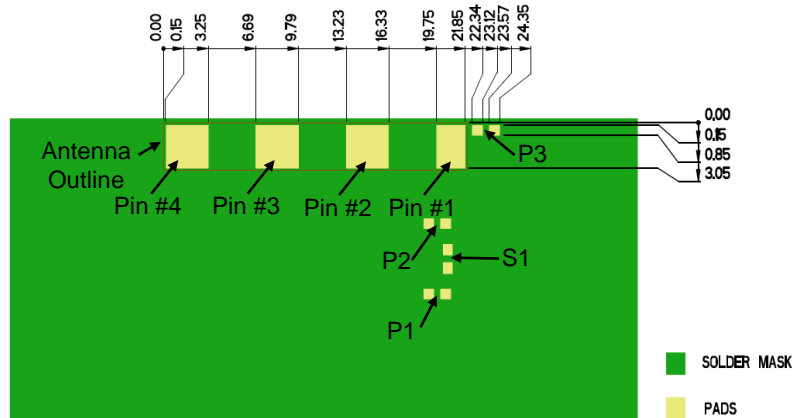
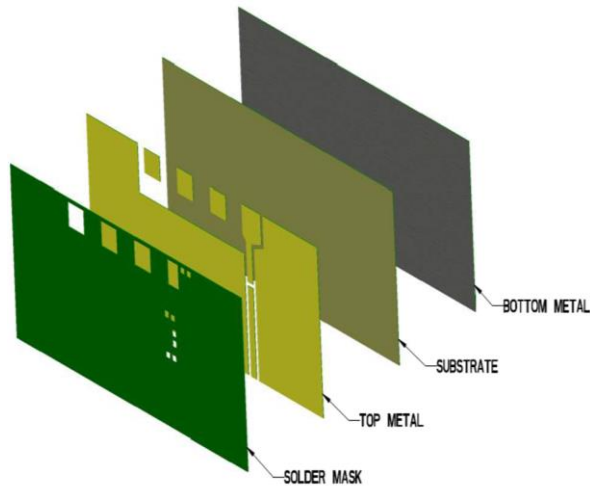

* VIAS: Diam. 0.2mm, (no vias on transmission lines).
Via holes must be covered by solder mask

Pin Descriptions

Pin#	Description
1	Feed
2	Dummy Pad
3	Dummy Pad
4	Dummy Pad

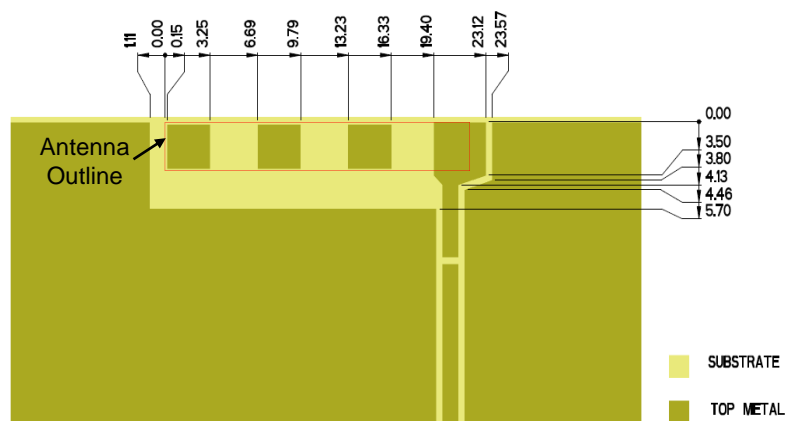

Matching Pi Network (Demo Board)

Component	Value	Tolerance
P1	2.4pF	±0.1pF
S1	0Ω	N/A
P2	DNI	N/A
P3	0Ω	N/A

*Actual matching values depend on customer design

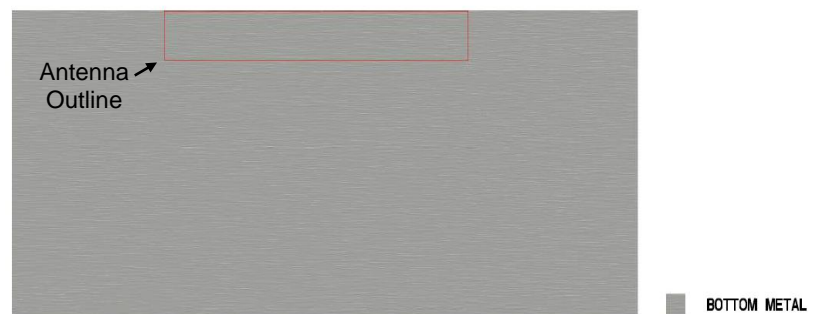
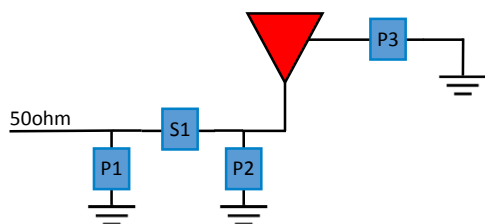



1.575 GHz Ethertronics' Embedded Antenna Specifications.
Ethertronics produces a wide variety of standard and custom antennas to meet user needs.

Antenna Demo Board
1001011-02 Off-Ground

Part Number	A (mm)	B (mm)	C (mm)
1001011-02	72.0	50.0	15.0

