



Get In-depth Support for Saving Energy by Visualizing Each Power Consumption



200kWh

Inverter air-conditioning power consumption visualization

Refrigerating power consumption and temperature* visualization

* When analog input is used

300kWh

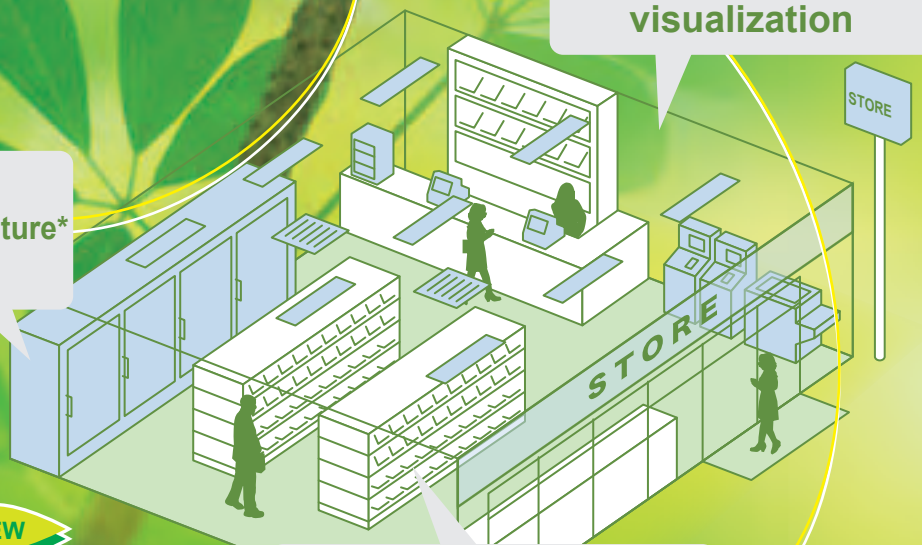

Lighting power consumption and illumination* visualization

* When analog input is used

50kWh

NEW

NEW



KW2G
Eco-POWER METER
Standard type



KW2G-H
Eco-POWER METER
SD memory card type



KW2G / KW2G-H
Eco-POWER METER
Expansion unit (Power measurement and Pulse output)



KW1M
Eco-POWER METER
Standard type



KW1M-H
Eco-POWER METER
SD memory card type



KW1M-R
Eco-POWER METER
Built-in wireless type

(Slave unit)



KW7M
Eco-POWER METER
DIN rail



KW4M
Eco-POWER METER
DIN 48

IP66



KW8M
Eco-POWER METER
DIN 48x96



Visualizing energy consumption is the first step toward energy savings.

Install Eco-POWER METERS in lighting equipment, air conditioners, and production equipment to measure power consumption and check the current status. Then, with specific targets in place, the implementation and management of an energy savings plan is quick and simple. Visualizing target achievements improves the energy usage cycle and allows for changes to be made to maximize efficiency.

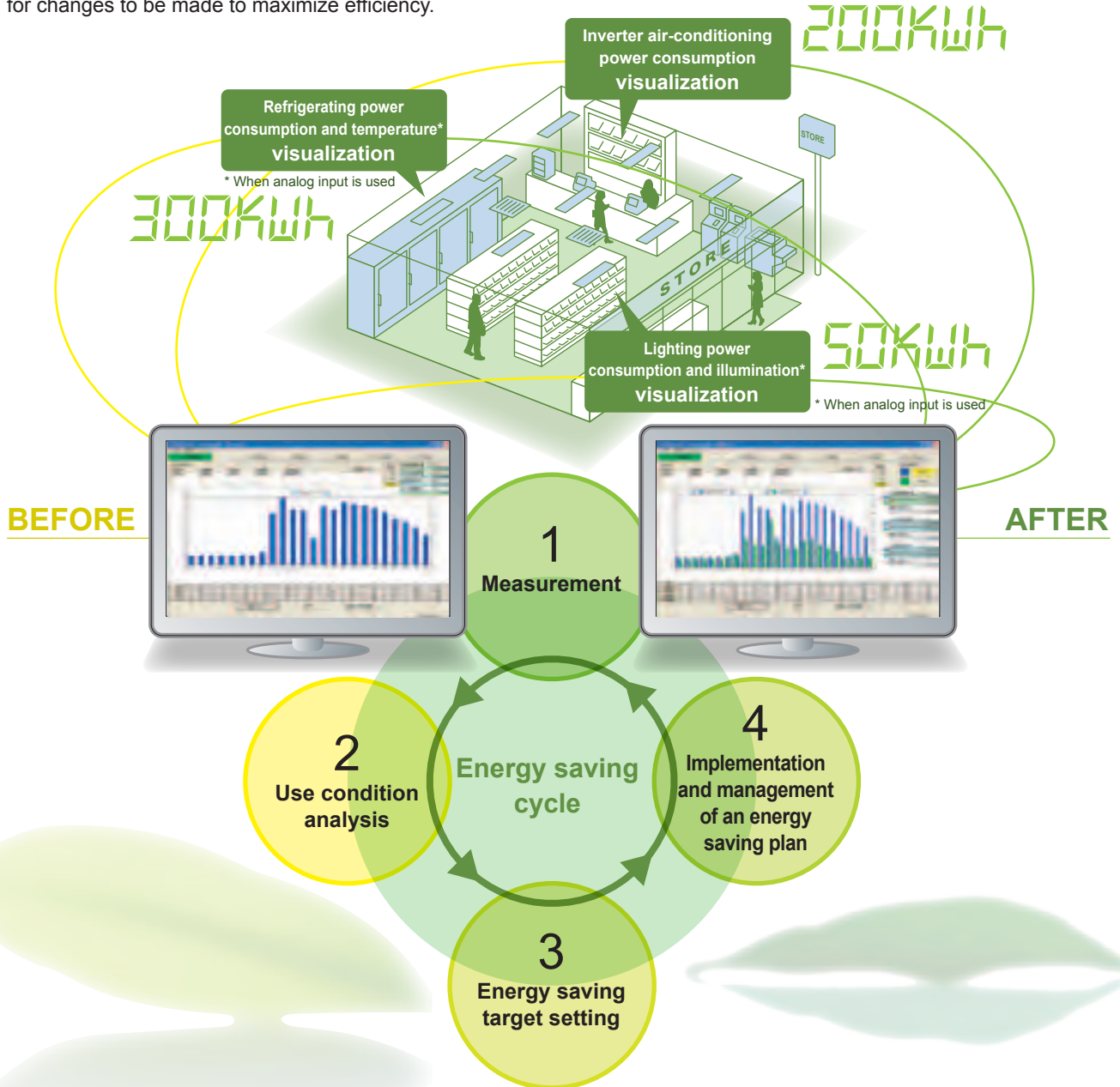

Market Trend

To reduce the usage of earth's resources, demand for a longer product lifecycle increases.



3 Year Warranty

3 year warranty
Factory Automation
Devices Products

Company direction

Pursue and supply high quality standard products which can be safely used in long term.

* Please refer to our website for warranted products and extent of 3 year warranty.

TYPICAL APPLICATIONS



Convenience stores

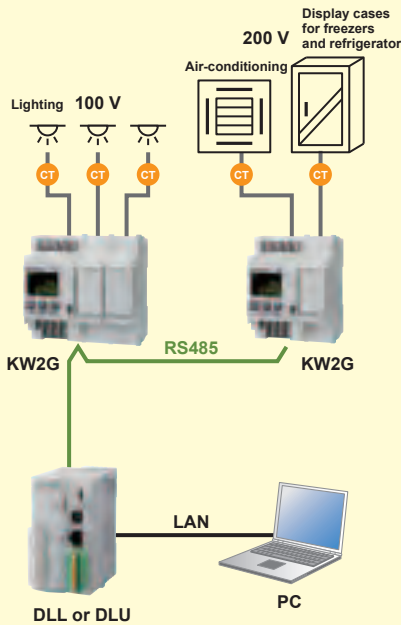

You can add only the required number of units in a small switchboard. Ideal for small stores.

Connector-expandable type

KW2G Eco-POWER METER



Schools and supermarkets

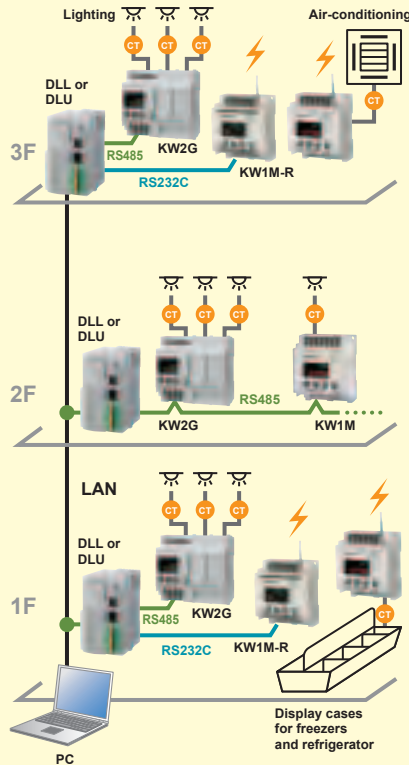

(Master unit)
KW1M-R Eco-POWER METER
(Slave unit)

Wiring work not required. Ideal if the layout is frequently changed.

Built-in wireless type



You can add only the required number of units, preventing waste.

Connector-expandable type

KW2G Eco-POWER METER



Plants

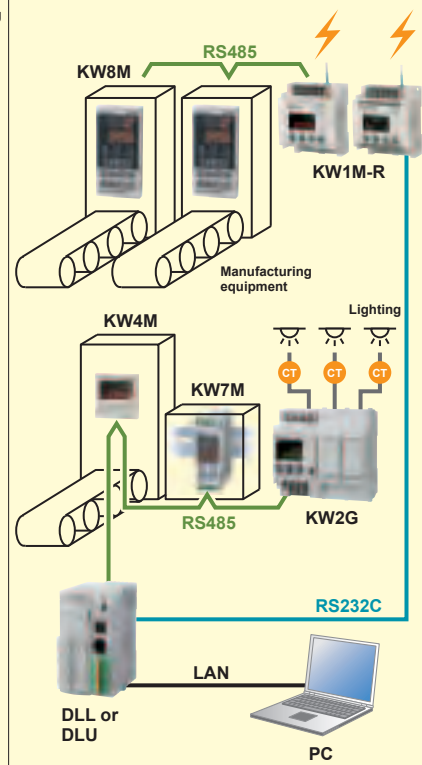

Mountable on a panel surface. Applicable to 400 V equipment.

Panel surface mount type

KW8M Eco-POWER METER



Mountable on a panel. Waterproof (IP66).

Waterproof type

KW4M Eco-POWER METER



Designed for DIN rail mounting, ideal for installation in a panel.

Panel-mount DIN rail type

KW7M Eco-POWER METER



Expandable for large equipment with multiple power supplies.

Connector-expandable type

KW2G Eco-POWER METER

Easy when you want small-scale visualization or for trial runs



Easy to measure. You can immediately check data on a PC.

SD memory card type

KW1M-H Eco-POWER METER











Easily measure multiple circuits, immediately view results on a PC screen.

SD memory card type

KW2G-H Eco-POWER METER

Eco-POWER METER SELECTION GUIDE

Needs	Recommended model
<ul style="list-style-type: none"> ■ Need to measure power of general-purpose CT installed at facility ■ Need to measure high current circuits 	<p>KW8M 1 A / 5 A CT input type </p> <ul style="list-style-type: none"> • Capable of direct input from 1 A / 5 A CT in the secondary side and up to 4,000 A CT in the primary side without using a dedicated CT
<ul style="list-style-type: none"> ■ Need to measure multiple points ■ Need to measure micro-power such as standby power ■ Need to measure existing equipment without line stoppage ■ Need to load analog data or pulse data 	<p>KW2G Series </p> <ul style="list-style-type: none"> • Expandable, as needed, to up to 7 expansion units. • Able to measure micro-power. • Simple measurement function enables measuring CT power only. • The environmental conditions and power can be monitored by using expansion units. (Analog input and pulse input types)
<ul style="list-style-type: none"> ■ Need to simply visualize data on Eco-POWER METER ■ Need to reduce initial costs ■ Need to use the Eco-POWER METER for trials ■ Need alternative cable communications (RS485 and LAN) 	<p>KW1M-H / KW2G-H </p> <ul style="list-style-type: none"> • Main unit has built-in memory. • Transfer of data to SD memory card allows visualization on PC screens, and with the KW2G-H, no wiring needed except for operating power supply.
<ul style="list-style-type: none"> ■ Need to measure three-phase four-wire systems 	<p>KW1M Series (except AKW1110) and KW8M Series </p> <ul style="list-style-type: none"> • Direct measurement even of three-phase, four-wire 400 V AC system can be done without VT.
<ul style="list-style-type: none"> ■ Need to collect data wirelessly ■ Need to reduce installation costs and man-hour of data collection ■ Need to flexibly alter equipment layout ■ Need to bypass cabling difficulties 	<p>KW1M-R </p> <ul style="list-style-type: none"> • Installation costs reduced because no wires are needed for communications. • Auto routing system for easy wireless set up • RS485 connection enables other Eco-POWER METERS to be ready for wireless communications.
<ul style="list-style-type: none"> ■ Need waterproofing for use of water 	<p>KW4M </p> <ul style="list-style-type: none"> • IEC IP66 certified protective structure
<ul style="list-style-type: none"> ■ Need to monitor demand 	<p>KW1M-H / KW8M High performance type </p> <ul style="list-style-type: none"> • Built-in simple demand function • Alarm outputs when demand target value is exceeded. * Demand function of Eco-POWER METER is that of Japanese specifications.
<ul style="list-style-type: none"> ■ Need low-cost power meter ■ Need capability to measure 200 V three-phase three-wire system, etc. 	<p>KW1M (AKW1110), KW4M and KW7M </p> <ul style="list-style-type: none"> • Space-saving design at a reasonable price achieve visualization.

USEFUL FUNCTIONS

1 A / 5 A CT input type

When you want to use a general-purpose CT

Without using a dedicated CT, direct input from up to 4,000 A CT in the primary side, 1 A or 5A CT in the secondary side is possible.



KW8M
1 A / 5 A CT input type

You can measure with a direct connection to an already-installed large-capacity general-purpose CT.

Other Eco-POWER METER Series

When taking dedicated CT measurements of more than 600 A

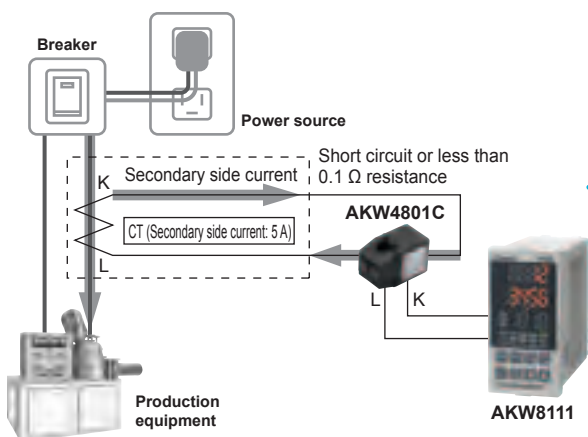

KW8M 1 A / 5 A CT input type

When taking large-capacity general-purpose CT measurements of more than 600 A

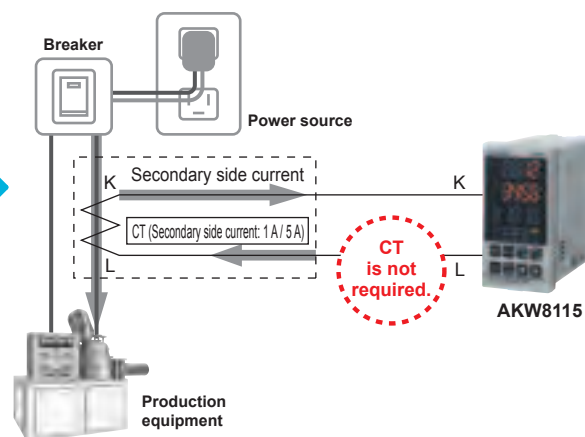

Eco-POWER METER Series accuracy does not include CT error. For dedicated CT measurements of more than 600 A, two CTs are necessary, but since the 1 A / 5 A CT input type **KW8M**, direct input from a single CT is possible, and you can carry out measurement with higher accuracy than provided by other Eco-POWER METER Series models.
For measurements of less than 600 A, measurement from a single CT, whether dedicated or general-purpose, is possible.

Inverter (primary side) measurement function

For measurement of inverter power supply equipment introduced for saving energy

Owing to general susceptibility to high frequency interference, it is said to be difficult to accurately measure power supplied by inverters.



Entire Eco-POWER METER Series
*Only Eco-POWER METERS with power measurement function

Our customers expressed strong demand for a line-up of Eco-POWER METERS that would enable measurement of inverter power supplies (primary side).

Ideal for measuring inverter power for large equipment, lighting, etc.

Application example



Compressor



Molding machine



Lighting

USEFUL FUNCTIONS

Unit expansion possible function

Up to 8 units! expandable to suit conditions of use without waste!

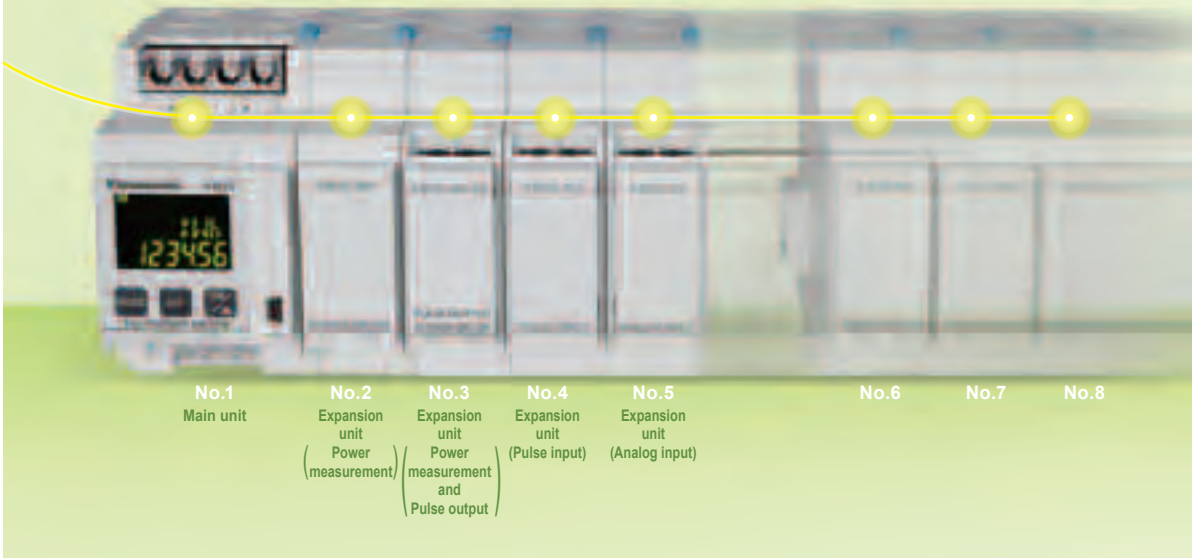

You can get pulse output from each measurement circuit

Application example

Expansion unit (AKW2160G) can be used to monitor integrated electric power value according to measured power or to issue alarms from pulse output, and can be controlled by PLC or other host system.

Using pulse output it is easy to connect to other companies' equipment with pulse input functions.

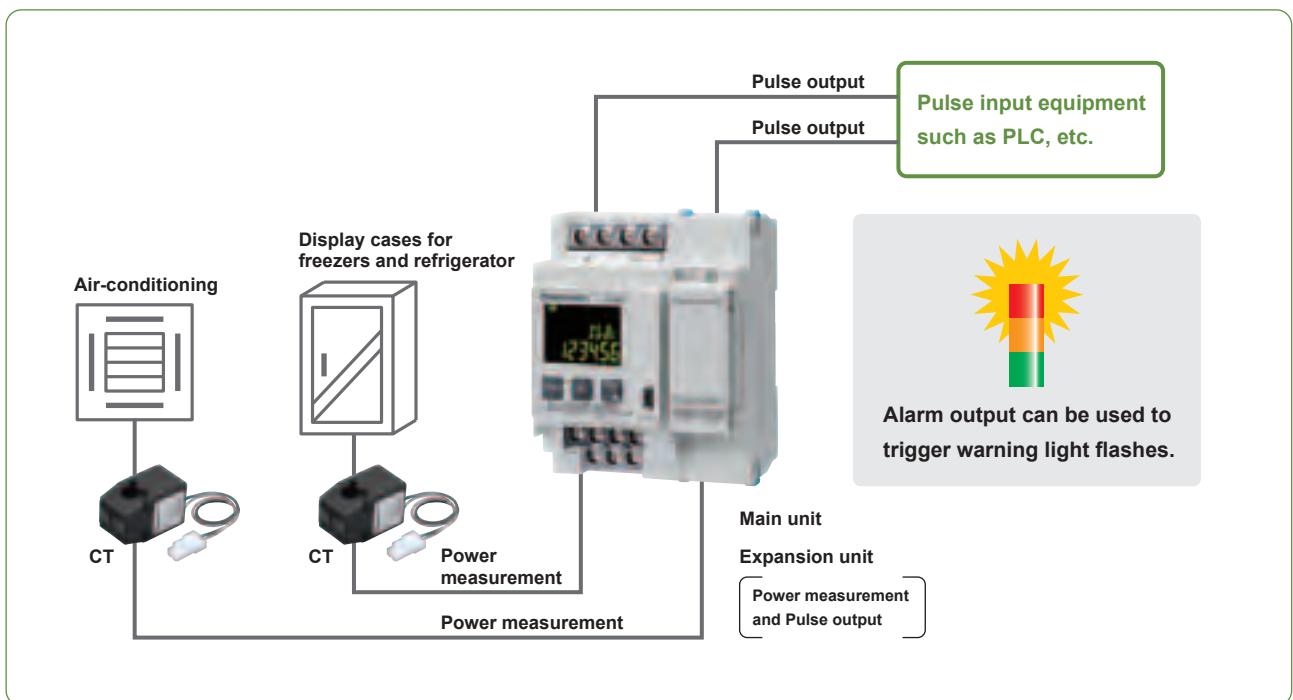

Easy wire-saving expandability brings diversity of measurement

Eliminate excess wiring by using up to seven expansion units to add-on the required number of CT inputs for your application.

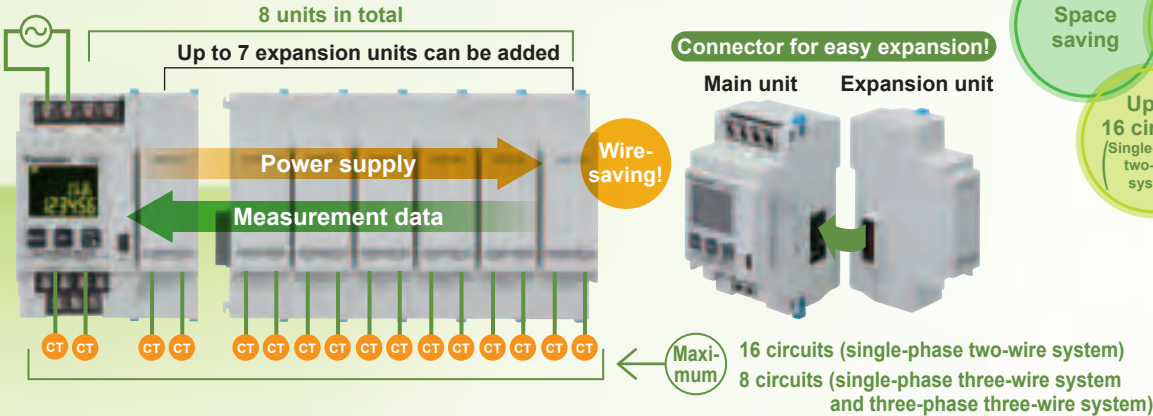

Connectable to various sensors as well as electric power

Application example

Air/water consumption, temperature, humidity, illumination and other environmental conditions along with power can be monitored by using expansion units for pulse/analog input.

- Power measurement
 - Main unit (AKW2010G)
 - Main unit (AKW2020G)
 - Expansion unit (AKW2110G)
 - Expansion unit (AKW2160G)
- Pulse input
 - Main unit (AKW2010G) = one input
 - Main unit (AKW2020G) = one input
 - Expansion unit (AKW2152G) = two inputs
- Analog input
 - Expansion unit (AKW2182G) = two inputs

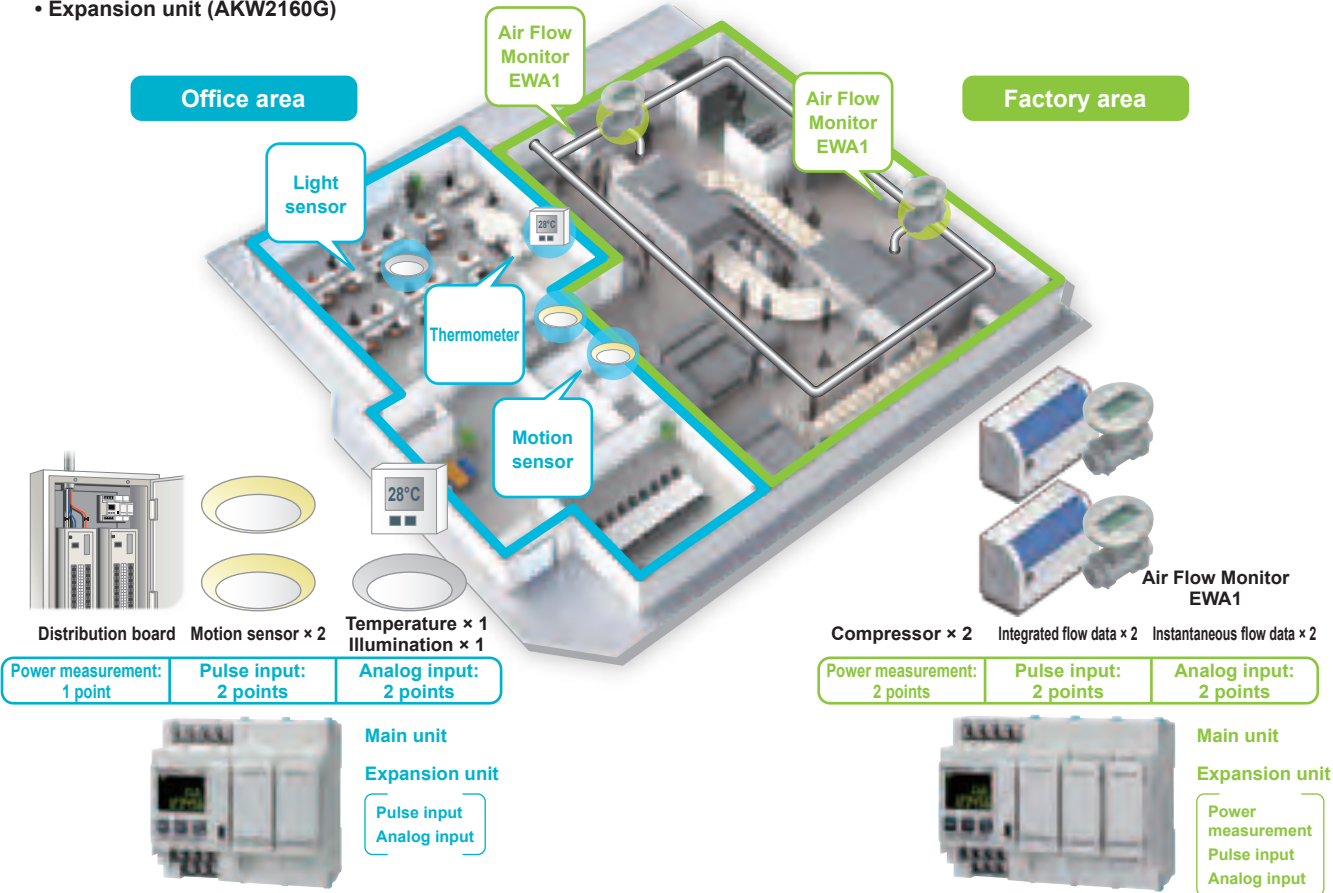

USEFUL FUNCTIONS

SD memory card function

Easy to implement, visualization of energy usage made easy!



Measurement data is automatically saved to an SD memory card.

Data collection is possible without a network.

- Data can be saved at intervals of 1, 5, 10, 15, 30, or 60 minutes.
- Previous power usage is displayed on screen (For KW1M-H: up to 1.5 years worth, for KW2G-H: up to 8 days worth).
- Lithium battery backup eliminates worries during power outage.
- Data is stored to memory of main unit when an SD memory card is not inserted.



Measurement data that is saved to the SD card can be easily displayed in graph form using the free KW View software tool.

- No complicated settings are required. Data from multiple Eco-POWER METERS can be compared in a single graph.
- In addition to electrical power, create comparison graphs for pulse data or analog data loaded by KW2G-H expansion unit (pulse input type and analog input type).



Ideal for switchboards or embedded devices

Application example

SD memory card compatibility enables economical implementation without the need to set up an external data loggers and a LAN or other network connection for measuring and storing the data. Takes only a small space in an electrical switchboard or embedded device and is ideal for small-scale measurement.

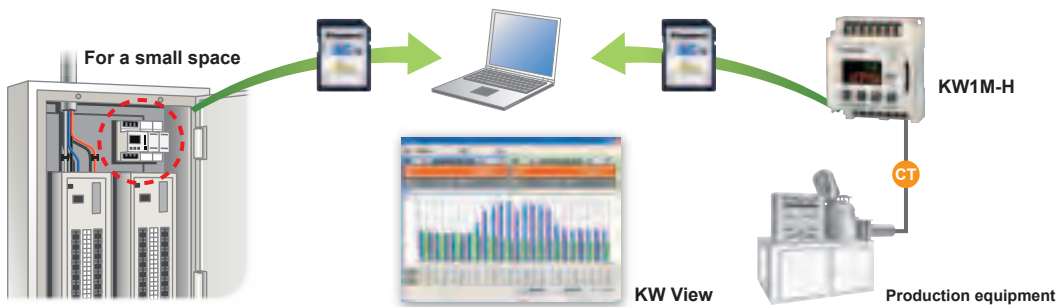

For measurements at remote locations

Application example

Using the free KW Watcher software, you can simultaneously graph data stored in the Data logger as well as on the SD memory card.

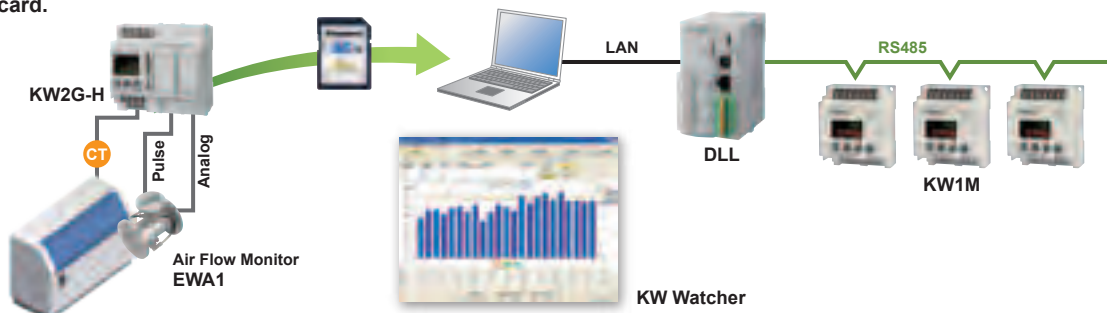

Wireless capability

Easy wire-saving in existing facilities where wiring is difficult



KW1M-R

Going wireless reduces the labor and installation cost for implementation

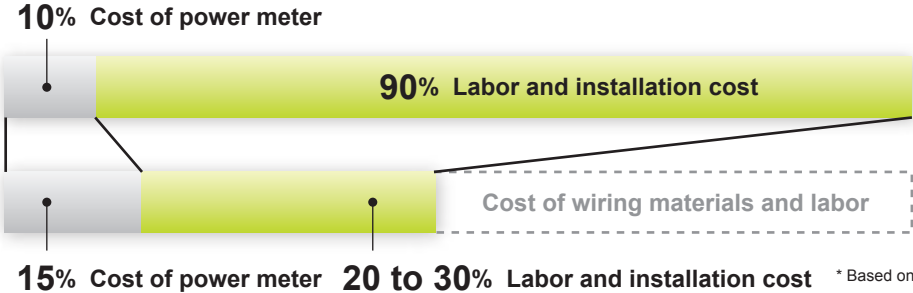

About half!

* Based on internal research
Actual costs depend on site conditions.

Wireless auto routing allows easy communications setting via the built-in screen. Using RS485 connection also enables wireless communications other Eco-POWER METERS besides the KW1M-R

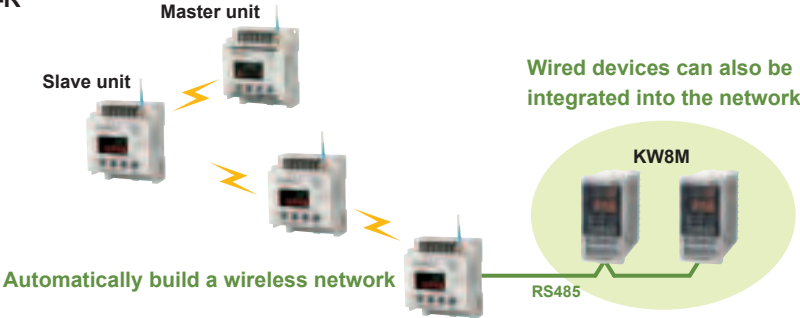

You can connect to up to 99 MEWTOCOL devices, 247 MODBUS (RTU) devices (incl. slave units).

Ideal for installation where wiring is difficult or where equipment layout flexibility is required **Application example**

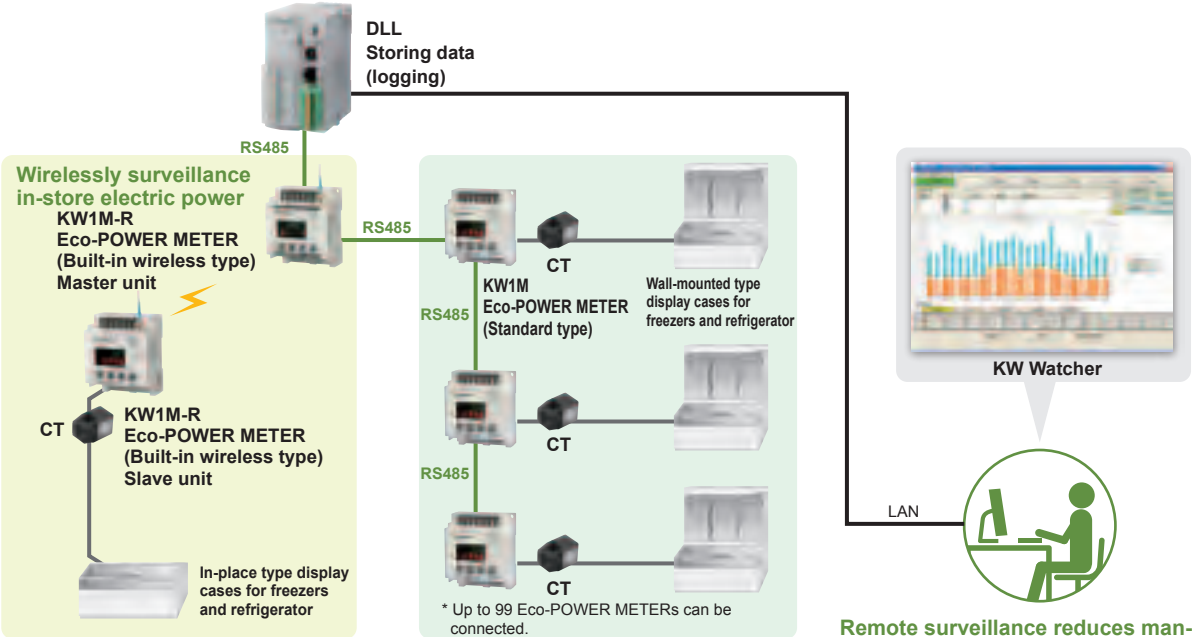

*Please contact our sales offices for more information about which areas this product can be used.

USEFUL FUNCTIONS

Micro-power measurement function

You can even visualize standby power

Standby power is a key to saving energy

By understanding both operating power and standby power, you can reduce non-operational energy wastage and initiate power-saving activities that go beyond what was formerly possible.



KW2G and KW2G-H can also measure fine currents. When the load current declines, micro-power measurement mode is automatically activated (auto range switching function).

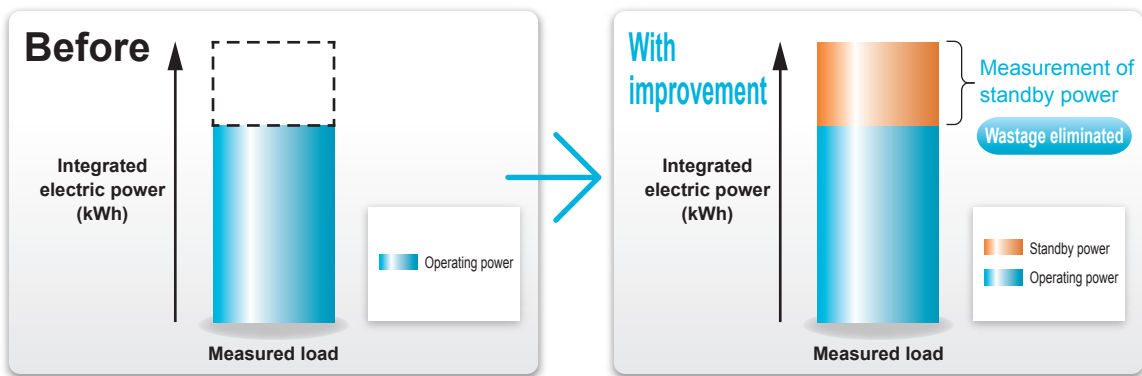

Simple measurement function

For existing equipment that must stay switched on and sequential measurement



Ideal for existing facilities where it is better not to switch off equipment and for sequential measurement **Application example**

No power supply wiring needed for the measuring the load! Because connection to the CT is possible, electric power measurement can be done without powering down the equipment.

- STEP1** Phase and wire system setting (for each unit)
- STEP2** Set simple measurement mode
- STEP3** Voltage and power factor setting (common to each unit)
- STEP4** Set simple measurement mode

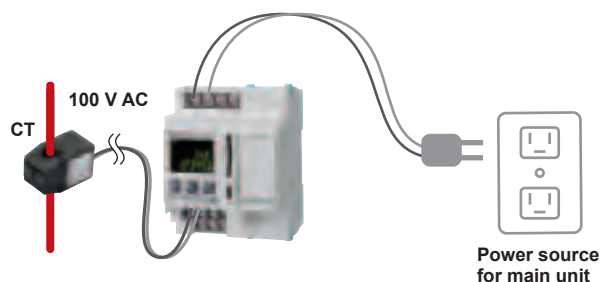

Simple demand function

Affordable peak demand control!

Estimate power consumption peak demand and get support for power management and cost-efficiency.



Operation overview of simple demand control

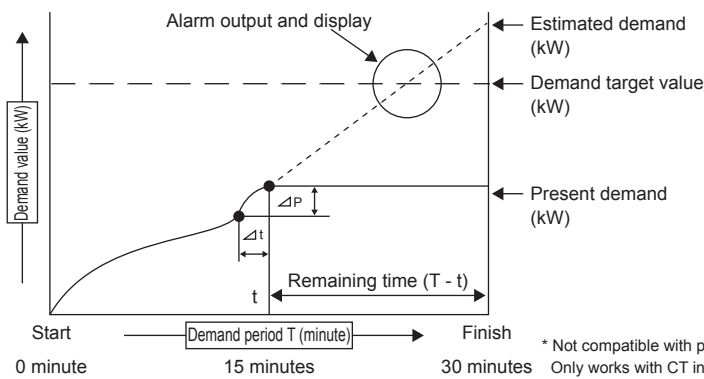

The simple demand function averages electric power during 30-minute periods and estimates demand on a per-minute basis.

* Not compatible with pulse input.
Only works with CT input (power measurement).

* The demand function of Eco-POWER METER is that of Japanese specifications.

Demand control for cost-efficiency

Application example



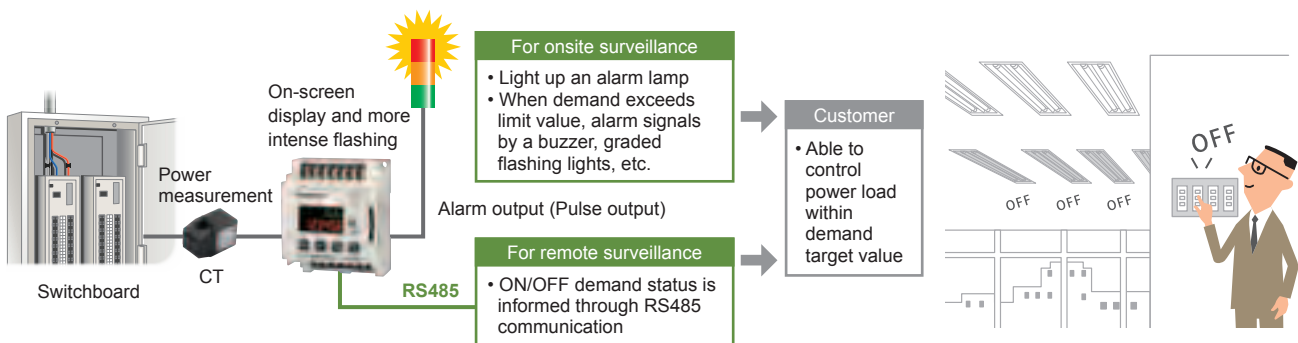





If demand exceeds present demand or estimated demand target values, an alarm alerts the customer.



*Simple demand should be treated as a rough guide. Power-use scheduling is set by the Eco-POWER METER.

PERFORMANCE COMPARISON

○ : Available
— : Not available

Product name	Main unit		Expansion unit				KW1M Standard type	KW1M-H SD memory card type		
	KW2G	KW2G-H	KW2G / KW2G-H							
	Standard type	SD memory card type	Power measurement	Power measurement and Pulse output	Pulse input	Analog input				
Appearance	 DIN	 DIN	 DIN	 DIN	 DIN	 DIN	 DIN Screw Frame	 DIN Screw Frame	 DIN Screw Frame	
Model No.	AKW2010G	AKW2020G	AKW2110G	AKW2160G	AKW2152G	AKW2182G	AKW1110	AKW1111	AKW1121	
Dimensions (mm inch) (W × H × D)	50×95×65 1.97×3.74×2.56		25×95×65 0.98×3.74×2.56				75×90×50 2.95×3.54×1.97			
Mounting method	DIN rail (sold separately)	○	○	○	○	○	○	○	○	
	Screw installation	—	—	—	—	—	○	○	○	
	Mounting frame (sold separately)	—	—	—	—	—	○	○	○	
	In panel mounting	○	○	○	○	○	○	○	○	
On panel mounting	—	—	—	—	—	—	○ [Mounting frame (sold separately) is required.]			
Operating power supply	100 to 240 V AC									
Input measured voltage (Select with setting mode)	100/200 V AC system					—	—	100/200 V AC system	100/200/400 V AC system	
Phase and wire system	Single-phase two-wire system	○	○	○	○	—	—	○	○	○
	Single-phase three-wire system	○	○	○	○	—	—	○	○	○
	Three-phase three-wire system	○	○	○	○	—	—	○	○	○
	Three-phase four-wire system	—	—	—	—	—	—	—	○	○
Load measurement for 400 V AC system (Note 1)	External voltage transformer (VT) required.					—	—	External voltage transformer (VT) required.	Transformer not required Direct input possible	
Current transformer (CT)	Dedicated type: 5 A, 50 A, 100 A, 250 A, 400 A and 600 A					—	—	Dedicated type: 5 A, 50 A, 100 A, 250 A, 400 A and 600 A		
Communication	Interface	Conforming to RS485								
	Communication protocol	MEWTOCOL/MODBUS (Selectable with setting mode) Restrictions apply. Please check communication specifications column.								
	Number of connected units	99 (max.)								
Number of pulse input point (Note 2)	1 point	1 point	—	—	2 points	—	—	1 point	1 point	
Number of pulse output point	1 point	1 point	—	1 point	—	—	1 point	1 point	1 point	
Number of analog input point (Note 3)	—	—	—	—	—	2 points	—	—	—	
Excess alarm output	Instantaneous active electric power	○	○	—	○	—	—	○	○	○
	Current value	○	○	—	○	—	—	○	○	○
	Stand-by electric power	○	○	—	○	—	—	—	○	○
	Preset value	○	○	—	—	—	—	—	○	○
	Demand (Note 4)	—	—	—	—	—	—	—	—	○
Main unit memory function	—	○	—	—	—	—	—	—	○	
External memory function	—	○	—	—	—	—	—	—	○	
Calendar timer function	—	○	—	—	—	—	—	—	○	
Simple measurement	○	○	○	○	—	—	—	—	—	
Measuring items	Integrated electric power	○ (Active)				—	—	○ (Active)	○ (Active)	○ (Active)
	Instantaneous electric power	○ (Active, Reactive, Apparent, Regenerative)				—	—	○ (Active)	○ (Active)	○ (Active)
	Current	○ (R, N/S, and T)				—	—	○ (R and T)	○ (R, S, and T)	○ (R, S, and T)
	Voltage	○ (RS, RT, and TS)				—	—	○ (R and T)	○ (R, S, and T)	○ (RS, RT, and TS)
	Electricity charge (Note 5)	○	○	Displayed on the main unit	Displayed on the main unit	—	—	○	○	○
	Conversion carbon dioxide value	○	○			—	—	○	○	○
	Power factor	○	○			—	—	—	○	○
	Frequency	○	○	—	—	—	—	○	○	
	Hour meter	—	—	—	—	—	—	○	○	○
	Pulse count value	○	○	—	—	○ (Note 6)	—	—	○	○
Simultaneous power and pulse measurement	○	○	—	—	—	—	—	○	○	
Tool and software (free of charge)	KW Monitor	○	○	○	○	○	○	○	○	
	KW Watcher	○	○	○	○	○	○	○	○	
	KW View	—	○	○ When connected to AKW2020G				—	—	○
	KW Network monitor	—	—	—	—	—	—	—	—	
Standard	CE and S-MARK	CE	CE and S-MARK	CE	CE and S-MARK	CE and S-MARK	CE and S-MARK	CE and S-MARK	CE and S-MARK	

Notes: 1) A VT (secondary side rated voltage: 110 V) is needed to measure loads that exceed rated input voltage.
 2) Input method: contact/non-voltage contact (open collector)
 3) To set input range of analog input unit using setting mode and select voltage 0 to 5 V/1 to 5 V, current 0 to 20 mA/4 to 20 mA.
 4) The demand function of Eco-POWER METER is that of Japanese function.
 5) Eco-POWER METER is primarily designed for managing energy saving. It is not intended to be used for billing.
 6) Displayed on the main unit

○ : Available
 — : Not available

Product name	KW1M-R Built-in wireless type (Note 1)		KW7M DIN rail	KW4M DIN□48		KW8M DIN48×96		
	Master unit	Slave unit		MEWTOCOL type	MODBUS type	High performance type	1 A / 5 A CT input type	
Appearance								
Model No.	AKW1000	AKW1131	AKW7111	AKW5111 AKW5211	AKW5112 AKW5212	AKW8111	AKW8111H	AKW8115
Dimensions (mm inch) (W × H × D)	75×90×50 2.95×3.54×1.97 (Excluding the antenna)		22.5×75×100 0.89×2.95×3.94	Screw terminal type: 48×48×81.9 1.89×1.89×3.22 11-pin type: 48×48×87.5 1.89×1.89×3.44		48×96×98.5 1.89×3.78×3.88		
Mounting method	DIN rail (sold separately)	○	○	○	○	—	—	—
	Screw installation	○	—	—	—	—	—	—
	Mounting frame (sold separately)	—	—	—	○	○	○	○
	In panel mounting	○	○	○	○ [Terminal socket (sold separately) is required.]	—	—	—
	On panel mounting	—	—	—	○	○	○	○
Operating power supply	100 to 240 V AC							
Input measured voltage (Select with setting mode)	—	100/200/400 V AC system	100/200 V AC system			100/200/400 V AC system		
Phase and wire system	Single-phase two-wire system	—	○	○	○	○	○	○
	Single-phase three-wire system	—	○	○	○	○	○	○
	Three-phase three-wire system	—	○	○	○	○	○	○
	Three-phase four-wire system	—	○	—	—	○	○	○
Load measurement for 400 V AC system (Note 2)	—	Transformer not required. Direct input possible.	External voltage transformer (VT) required.			Transformer not required. Direct input possible.		
Current transformer (CT)	—	Dedicated type: 5 A, 50 A, 100 A, 250 A, 400 A and 600 A	Dedicated type: 5 A, 50 A, 100 A, 250 A and 400 A			Dedicated type: 5 A, 50 A, 100 A, 250 A, 400 A and 600 A		(Note 4)
Communication	Interface	Conforming to RS485/RS232C	Conforming to RS485					
	Communication protocol	MEWTOCOL/MODBUS (Selectable with setting mode) Restrictions apply. Please check communication specifications column.	MEWTOCOL/MODBUS (Selectable with setting mode)	MEWTOCOL	MODBUS	MEWTOCOL/MODBUS (Selectable with setting mode)		
	Number of connected units	MEWTOCOL: Up to 99 units MODBUS: Up to 247 units	99 (max.)					
Number of pulse input point (Note 3)	—	1 point	—	1 point	1 point	1 point	1 point	1 point
Number of pulse output point	—	1 point	1 point	1 point	1 point	1 point	1 point	1 point
Number of analog input point	—	—	—	—	—	—	—	—
Excess alarm output	Instantaneous active electric power	—	○	○	○	○	○	○
	Current value	—	○	—	—	—	○	○
	Stand-by electric power	—	○	—	—	—	○	○
	Preset value	—	○	—	○	○	○	○
	Demand (Note 5)	—	—	—	—	—	○	—
Main unit memory function	—	—	—	—	—	○	—	
External memory function	—	—	—	—	—	—	—	
Calendar timer function	○	—	—	—	—	○	—	
Simple measurement	—	—	—	—	—	—	—	
Measuring items	Integrated electric power	—	○ (Active)	○ (Active)	○ (Active)	○ (Active)	○ (Active, Reactive, Apparent)	
	Instantaneous electric power	—	○ (Active)	○ (Active)	○ (Active)	○ (Active)	○ (Active, Reactive, Apparent)	
	Current	—	○ (R, S, and T)	○ (CT1 and CT2)	○ (CT1 and CT2)	○ (CT1 and CT2)	○ (CT1, CT2, and CT3)	
	Voltage	—	○ (RS, RT, and TS)	○ (between 1 and 2, between 2 and 3)	○ (between 1 and 2, between 2 and 3)	○ (between 1 and 2, between 2 and 3)	○ (between P1 and P0, between P2 and P0, between P3 and P0)	
	Electricity charge (Note 6)	—	○	○	○	○	○	○
	Conversion carbon dioxide value	—	○	—	○	○	—	—
	Power factor	—	○	—	—	—	○	○
	Frequency	—	○	—	—	—	○	○
	Hour meter	—	○	—	○	○	○	○
	Pulse count value Simultaneous power and pulse measurement	—	○	—	○	○	○	○
Tool and software (free of charge)	KW Monitor	—	○	○	○	○	○	○
	KW Watcher	—	○	○	○	—	○	○
	KW View	—	—	—	—	—	—	—
	KW Network monitor	○	○	—	—	—	—	—
Standard	— (Note 1)		CE and S-MARK	CE, UL, and S-MARK		CE and S-MARK		

Notes: 1) Please contact our sales offices for more information about which areas this product can be used.
 2) A VT (secondary side rated voltage: 110 V) is needed to measure loads that exceed rated input voltage.
 3) Input method: contact/non-voltage contact (open collector)
 4) Commercially available current transformer (CT) (When using secondary current 1 A or 5 A and when primary current is 4,000 A or less)
 5) The demand function of Eco-POWER METER is that of Japanese function.
 6) Eco-POWER METER is primarily designed for managing energy saving. It is not intended to be used for billing.

SOFTWARE TOOL

KW View

For KW1M-H / KW2G-H

For easy visualization of measurement data collected by an SD memory card

Display tool | Verification



- Simply load the measurement data (CSV file) collected in an SD/SDHC memory card into your PC. You can then display the data as a graph by month, day and hour, and print it out.
- Using easy operation, you can manage Eco-POWER METER data for up to 99 units.
- KW1M-H** graph shows display is in 60 minutes units (fixed).
- KW2G-H** graph shows display is in 15, 30 or 60 minutes units (fixed).
- NEW** Data for integrated electric power, pulse data (count values), analog data (converted to digital values) can now be displayed graphically.
- NEW** Automatic device recognition.



Before and after chart of integrated electric power KW View



Graph comparing integrated electric power KW View and temperature (analog)

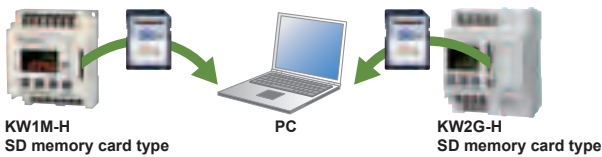

* Analog data (converted digital values) are only displayed on the graph for each hour.

KW Watcher

Compatible with all products (if data is stored by DLL or DLU)

For easy “visualization” of data collected in DLL and DLU* *DLL is the abbreviation for Data Logger Light. DLU is the abbreviation for Web Datalogger Unit.

Measurement monitoring software | Management



- Collected files stored according to unit of time on the Data logger, are downloaded as required to a PC and graphs and numerical data can be displayed for simple electric power, water amount, temperature, primary unit and air flow amount measurement values.
- Measurement is in 15 min, 30 min, and 60 min units.
- KW1M-H / KW2G-H** data stored on SD memory cards can also be displayed. (Requires change of KW Watcher settings)



Before and after chart of integrated electric power KW Watcher



Electric power use broken down by facility KW Watcher

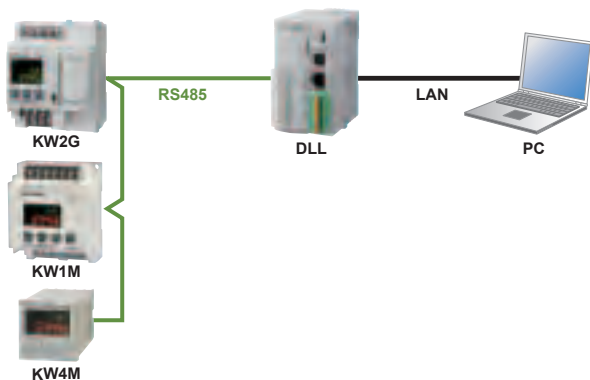

All software tool can be downloaded*, free of charge, from our website.

You can also check the required operating environments.

*Customer registration is required before you download.

KW Monitor

For easy visualization of real-time Eco-POWER METER data

Software for centralized control by PC | Analysis and Eco-POWER METER setting

- You can directly access the Eco-POWER METER via your PC.
Data can be constantly collected and easily displayed numerically or in graph form.
- Logging can be selected among 1 sec, 5 sec, 10 sec, 15 sec, 30 sec, 60 sec, 1 min, 5 min, 10 min, 15 min, 30 min, and 60 min units.
(Depending on communication conditions and number of connections, data may not be acquired for the collection period.)
- Electrical power can be measured either integrated or instantaneous.
- With simple demand functions both logging and demand estimation can be performed simultaneously.
Display of warning messages according to target value settings is useful for energy management.
- NEW** ■ Data for integrated electric power, pulse data (count values), analog data (converted to digital values) can now be displayed graphically.
- Communication protocol compatibility only with MEWTOCOL



Graph showing hour integrated value and total integrated value KW Monitor

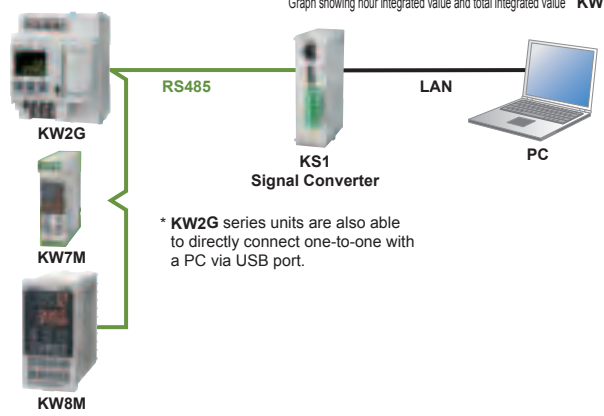

* KW2G series units are also able to directly connect one-to-one with a PC via USB port.

Eco-POWER METER setting

- For each Eco-POWER METER, settings can all be set, changed, or stored on a PC.
(Storage of setting values is possible only, via USB transfer, with the KW2G series.)
- Since changes can be made to multiple Eco-POWER METERS at the same time, the labor of setting units one at a time is saved.



Setting screen KW Monitor

KW Network Monitor

For wireless network tree check

Built-in wireless type For KW1M-R | Software for wireless network check | Verification

- This software is useful for making the "visualization" of network at the time of installation or occurrence of a problem.
- You can check the connection status of the wireless network and the terminal devices by connecting your PC to the master unit and carrying out simple operations, which will help you to quickly resolve problems.
- This software can read out an error log stored in KW1M-R (master unit).

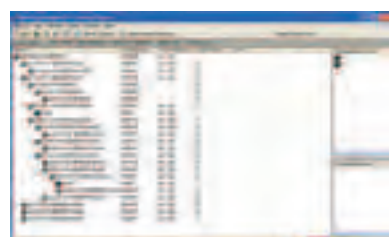

Wireless network confirmation screen KW Network Monitor

Specifications

KW2G / KW2G-H



* AKW2020G and AKW2160G have only CE certification marking.

KW2G / KW2G-H COMMON FEATURES

- Up to 7 expansion units can be added as required without need for power or other wiring.
Up to 16 circuits (single-phase two-wire) or 8 circuits (single-phase three-wire; three-phase three-wire)
- If an expansion unit (pulse input and analog input type) is used, flow, temperature, humidity and other environmental conditions can be monitored.
- By using an expansion unit (power measurement and pulse output), pulse output is possible for each measuring circuit.
- Capable of various types of measurement.
Simultaneous measurement of regenerative power (instantaneous), micro-power, inverter power (primary side), electrical power and pulse (flow, etc.)

- Simple measurement function enables measurement of electric power of only the CT.
- Via USB connection with a PC, using **KW Monitor**, you can easily check initial settings and operating status.
- Quick installation: The units fit DIN rails.
- Pulse output width can be freely set in the range of 1 to 100 ms; finer power values can be output to an external counter.
- Because pulse input status is displayed, the operational status of external connected devices can be monitored.

FEATURES OF KW2G-H

- Internal memory
Automatic logging function (read by SD memory card).
- Automatic logging of measurement data on expansion units.
- Built-in battery (clock and log data backup).

ORDER GUIDE

Product name		Phase and wire system	Operating power supply	Input measured voltage	Current transformer (sold separately)	Model No.	
KW2G / KW2G-H Eco-POWER METER	Main unit (Standard type)	Single-phase two-wire system Single-phase three-wire system Three-phase three-wire system	100 to 240 V AC 50 / 60 Hz	100 / 200 V AC system	Dedicated type 5 A, 50 A, 100 A, 250 A, 400 A, 600 A	AKW2010G	
	Main unit (SD memory card type)					AKW2020G	
	Expansion unit	Power measurement	Number of input points 2 channels	Input method Contact / No contact (open collector)		Input range Voltage: 0 to 5 V / 1 to 5 V (Note 3) Current: 0 to 20 mA / 4 to 20 mA (Note 3)	AKW2110G
		Power measurement and Pulse output (Note 1)					AKW2160G
		Pulse input (Note 2)					AKW2152G
		Analog input (Note 2)					AKW2182G

Notes: 1) Use a main unit (standard type) of Ver. 1.04 or later and a main unit (SD memory card type) of Ver.1.01 or later.
2) Use a main unit (standard type) of Ver. 1.02 or later. 3) Select with setting mode

MEASUREMENT ITEMS

Power measurement (for AKW2010G, AKW2020G, AKW2110G and AKW2160G)

Item	Unit	Data display range
Integrated electric power (Active) (Note 1)	kWh/MWh	0.00 to 9999.99 kWh to 9999.99 MWh, 0.00 to 9999999.99 kWh (when 9-digit display)
Instantaneous electric power	Active (Note 2)	kW
	Reactive (Note 2)	kvar
	Apparent	kVA
Current	R-current	A
	N/S-current	A
	T-current	A
	R (RS)-voltage	V
Voltage	S (RT)-voltage	V
	T (TS)-voltage	V
	Electricity charge (Note 3)	
Conversion carbon dioxide value	kg-CO ₂	0.00 to 999999
Power factor (Note 2)	Displayed on the main unit	-1.00 to 1.00 (without identify leading phase and lagging phase)
Frequency	Hz	47.5 to 63.0
Pulse count value (Note 4)		0 to 999999

Notes: 1) KW2G / KW2G-H can measure regeneration electric power. Integrated electrical power is not integrated (not subtracted) when detecting regeneration electric power.
2) While detecting regeneration electric power, minus is displayed on instantaneous active electric power and power factor.
3) Eco-POWER METER is designed chiefly to manage saving energy. It is neither intended nor can it be legally used for billing.
4) Displayed digit of pulse counter differs according to the pre-scale set by pre-scale setting mode.

Pulse input (for AKW2152G)

Item	Data display range
Pulse count value (Note)	0 to 999999

Note: The number of displayed digit of pulse count value differs according to the pre-scale set by pre-scale setting mode.

Analog input (for AKW2182G)

Item	Data display range
Converted digital value (Note)	-999999 to 999999

Note: The number of displayed digits of the converted digital values differs according to the preset decimal point position.

SPECIFICATIONS

For details, please refer to the Eco-POWER METER user's manual.

Main unit specifications

Item	Specifications
Rated operating voltage	100 to 240 V AC (Add to main unit)
Rated frequency	50 / 60 Hz common
Rated power consumption	Main unit: 6 VA, Expansion unit (Power measurement, Power measurement and Pulse output, and Analog input): 0.5 VA / unit, Expansion unit (Pulse input): 1.0 VA / unit (240 V AC at 25 °C 77 °F)
Allowable operating voltage range	85 to 264 V AC (85 % to 110 % of rated operating voltage)
Allowable momentary power-off time	10 ms
Ambient temperature	-10 to +50 °C +14 to +122 °F (-25 to +70 °C -13 to +158 °F) at storage
Ambient humidity	30 to 85 % RH (at 20 °C 68 °F), non-condensing
Display method	LCD with backlight (green), Upper: 5-digit (7-segment 1-digit + 16-segment 4-digit), Lower: 6-digit (7-segment)
Number of connectable expansion units	Max. 7 units
Power failure memory method	EEPROM (more than 1,000,000 overwrite), Memory items: setting value and integral measuring value
Weight	Main unit (Standard type): 180 g, Main unit (SD memory card type): 185 g, Expansion unit (Power measurement): 80 g, Expansion unit (Power measurement and Pulse output, Pulse input and Analog input): 85 g

Electric power input specifications (for AKW2010G, AKW2020G, AKW2110G and AKW2160G)

Item	Specifications	
Accuracy (without error in CT and VT)	Integrated electric power and Instantaneous electric power	Within ± (2.0 % F.S. + 1 digit) (at 20 °C 68 °F, rated input, rated frequency, power factor 1) *Accuracy coverage: 10 to 100 % of rated current
	Current	Within ± (1.0 % F.S. + 1 digit) (at 20 °C 68 °F, rated input, rated frequency, power factor 1) *Accuracy coverage: 10 to 100 % of rated current
	Voltage	Within ± (1.0 % F.S. + 1 digit) (at 20 °C 68 °F, rated input, rated frequency, power factor 1)
	Temperature characteristics	Within ± (1.0 % F.S. + 1 digit) (Range of -10 to +50 °C 14 to 122 °F, rated input, power factor 1)
	Frequency characteristics	Within ± (1.0 % F.S. + 1 digit) (Frequency change ± 5 % based on rated frequency, rated input, power factor 1)

Memory specifications of main unit (for AKW2020G)

Item		Specifications	
Logging functions	File type 1 (instantaneous value) (Note 1)	Save cycle	15 min (00 hr. 00 min 00 sec after the day) (fixed)
		Save data	(Instantaneous value) Integrated electric power (1) (2), Instantaneous active electric power (1) (2), Instantaneous reactive electric power (1) (2), Instantaneous apparent electric power (1) (2), R-current (1), R (T)-current (2), S (N)-current, R/RS-voltage (1), R (T/TS)-voltage (2), RT-voltage, Power factor (1) (2), Frequency, Count value, Converted digital value for CH0, Converted digital value for CH1, Pulse count value for CH0 and Pulse count value for CH1
		Save data amount	96 records per file (max. approx. 8 days worth of data)
	File type 2 (difference value) (Note 1)	Save cycle	15 min (00 hr. 00 min 00 sec after the day) (fixed)
		Save data	(Difference value) Integrated electric power (1) (2), Count value, Pulse count value for CH0 and Pulse count value for CH1
		Save data amount	96 records per file (max. approx. 8 days worth of data)
	File type 3 (instantaneous value detail) (Note 1)	Save cycle	Select among 1 min, 5 min, 10 min, 15 min, 30 min, or 60 min (Saved timing) When 1 min is selected: 00 sec after the minute When 10 min is selected: 00, 10, 20, 30, 40, 50 min after the hour When 15 min is selected: 00, 15, 30, 45 min after the hour When 60 min is selected: 00 min after the hour
		Save data	Integrated electric power (1) (2), Instantaneous active electric power (1) (2), Instantaneous reactive electric power (1) (2), Instantaneous apparent electric power (1) (2), R-current (1), R (T)-current (2), S (N)-current, R/RS-voltage (1), R (T/TS)-voltage (2), RT-voltage, Power factor (1) (2), Frequency, Count value, Converted digital value for CH0, Converted digital value for CH1, Pulse count value for CH0 and Pulse count value for CH1
		Save data amount	Max. 720 records, 12 hours approx. worth of data (when the save cycle is set to one minute)
	Main unit display		Integrated electric power by day (latest data covering 8 days period) / Integrated electric power by hour (latest data covering 12 hours period)
Calendar timer function		Time accuracy Monthly accuracy: ±30 sec (at 25 °C 77 °F)	
Content of battery backup		Time measurement and Log data	
Battery life (Note 2)		2 years approx. (at 25 °C 77 °F, in power-off state)	

Notes: 1) Using the setting mode, you can select whether or not to write to the SD memory card for each of file types 1, 2, and 3. Files can be created for each unit.
2) When the battery gets low, the BATT display will start flashing. Please replace the battery in accordance with the battery replacing procedure. Also, battery life will be shortened if the main unit is used in a high temperature environment.

* While measuring, data is collected in the memory of main unit. If, while measuring, the memory capacity of main unit is reached, data will be overwritten in succession starting from the oldest data. Initialization of the main unit memory is possible.

External memory specifications (for AKW2020G)

• SD memory card slot

Item	Specifications
Support media	SD memory card (Note 1)
Supported format standards	Compliant with SD and SDHC standards (Note 2)

Notes:
1) Operation verified SD memory card: Panasonic Corporation SD/SDHC memory card 2 GB and 4 GB class 4 and over
2) To format SD memory cards, please download and use the formatting software available on the Panasonic website.
The file system on a SD memory card that was formatted using standard PC software does not comply with the SD memory card standard.

<SD memory card handling precautions>

Data saved on an SD memory card may be lost in the following cases. Please note that Panasonic Industrial Devices SUNX is not responsible for any losses of recorded data and other direct and indirect damages.
1) When a customer or a third party incorrectly uses the SD memory card
2) When the SD memory card is affected by static electricity or electrical noise
3) When the SD memory card is taken out or the power is turned off while the SD memory card access LED of the unit is flashing (during data writing)
* It is recommended that you constantly back up important data to another medium.

Communication specifications

Item	Specifications	
	RS485 communication	USB communication (Note 5)
Protocol	MEWTOCOL / MODBUS (RTU) (selectable with setting mode)	—
Transmission function	—	Computer link (MEWTOCOL)
Isolation status	Isolated with the internal circuit	Isolated with the internal circuit
Number of connected units	99 units max. (Note 1) (Note 2)	—
Transmission distance	1,200 m 3,937 ft max. (Note 3)	—
Transmission speed	38,400 / 19,200 / 9,600 / 4,800 / 2,400 bps (selectable with setting mode)	12 Mbps (Full-speed)
Transmission format	Data length: 8-bit / 7-bit (selectable with setting mode) (Note 4) Parity: Not available / Odd number / Even number (selectable with setting mode) Stop bit: 1-bit / 2-bit (selectable with setting mode)	—
Communication method	Half-duplex	—
Synchronous system	Synchronous communication method	—
Ending resistance	120 Ω approx. (built-in)	—

Notes:
1) For RS485 converter on the computer side, we recommend SI-35 and SI-35USB (from LINE EYE Co., Ltd.).
2) When using SI-35, SI-35USB or PLC from our company (which can be connected up to 99 units), up to 99 Eco-POWER METER can be connected. [When using C-NET adapter, up to 32 Eco-POWER METER (max.)] In case using this system with the other devices, up to 31 Eco-POWER METER can be connected.
3) Please check with the actual devices when some commercial devices with RS485 interface are connected. The number of connected devices, transmission distance, and transmission speed may be different according to using transmission line.
4) With MODBUS (RTU) protocol, it works only with 8-bit. 5) When using the USB port, install the dedicated USB driver.

Pulse input specifications (for AKW2010G, AKW2020G and AKW2152G)

Item	Specifications	
Input mode	Addition (Fixed)	
Max. counting speed	50 kHz / 30 Hz (Select with setting mode)	
Pulse input (Min. input signal width)	0.01 ms (When 50 kHz selected) / 16.7 ms (When 30 Hz selected), ON : OFF ratio = 1 : 1 Contact / No contact (open collector)	
Input signal	• Impedance when shorted: Max. 1 kΩ • Residual voltage when shorted: Max. 2 V • Impedance when open: Min. 100 kΩ	
Output mode	HOLD (Over count)	
Prescale	Decimal point	Setting possible up to under 3-digit
	Range	0.001 to 100.000 (Set with setting mode)

Analog input specifications (for AKW2182G)

Item	Specifications	
Number of input points	2 channels	
Input range (Select with setting mode)	Voltage	0 to 5 V / 1 to 5 V (selectable with setting mode)
	Current	0 to 20 mA / 4 to 20 mA (selectable with setting mode)
Converted digital value	0 to 4000 (decimal number) (Note)	
Resolution	1/4000 (12 bits)	
Overall precision	±1 % F.S. or less (-10 to +55 °C +14 to 131 °F)	
Input impedance	Voltage	440 kΩ
	Current	125 Ω
Absolute maximum input	Voltage	- 0.3 to +10 V
	Current	- 2 to + 30 mA
Input protection	Diode	

Note: Digital conversion value differs according to the scaling conversion value set by setting mode. If the analog input value exceeds the upper or lower limit, the digital value will preserve the upper or lower limit.

Pulse output (Transistor output) specifications (for AKW2010G, AKW2020G and AKW2160G)

Item	Specifications
Number of output point	1 point
Insulation method	Optical coupler
Output type / Output capacity	Open collector / 100 mA 30 V DC
Pulse width (when pulse output with integrated active electric power selected)	1 to 100 ms (selectable with setting mode) (Note 1)
ON state voltage drop	1.5 V or less
OFF state leakage current	100 μA or less
Pulse output unit (selectable with setting mode)	0.001 kWh, 0.01 kWh, 0.1 kWh, 1 kWh, 10 kWh, 100 kWh /
	Power alarm (AL-P) / Current alarm (AL-C) / Stand-by power alarm (AL-S) / Counter (Cnt) (Note 2, 3)

Notes: 1) Pulse width setting is possible using main unit software AKW2010G Ver. 1.04 or later and AKW2020G Ver. 1.01 and later.
2) For normal operation of other functions, to switch on minimal pulse width of 1 to 10 ms, the maximum pulse output interval is 25 ms. Consequently, a minimum measurable pulse unit output setting of 40 pulses or less per 1 second is recommended.
How to calculate
Unit for pulse output: PL-P > Max. measurement power (kW) / 3,600 sec × 4 pulse/sec
When the pulse output unit is 0.001, the maximum power that can be properly measured by pulse output is 144 kW (3600 sec × 40 pulse/sec × 0.001).
Cautions:
(1) Count errors may occur if the pulse output is set to 40 pulses or more per 1 second.
(2) If the pulse output OFF time is set too short, count errors by connected counters, PLCs (Programmable Logic Controllers) may occur.
3) These count output specifications are only for the main unit.

KW1M / KW1M-H / KW1M-R



KW1M COMMON FEATURES

- Output of alarm signal is possible using the “alarm setting”.
- 50 mm 1.97 inch thickness makes it perfect for control panel installations.
- Selectable screw, DIN rail and panel installation.
- Display switchable between electrical power and electricity charge usage.
- Display of calculated CO₂ value possible
- Measurement of inverter power supplies (primary side) is available.

NEW

FEATURES OF KW1M-H

- Internal memory (Read by SD memory card)
- Built-in battery (for clock and log data backup)
- Calendar timer function.
- Simple demand function.

NEW

FEATURES OF KW1M-R

- Wireless capabilities eliminate need for LAN installation.
- Auto routing system for easy setup of a wireless network.
- Compatible with a wide range of AC power supply and directly installable in a distribution board.
- RS485 connection enables Eco-POWER METERS other than KW1M-R to be ready for wireless communications.
- Calendar timer function.
- Wired/Wireless selection function (AKW1131 only)
- Please contact our sales offices for more information about which areas this product can be used.

NEW

ORDER GUIDE

Product name	Phase and wire system	Operating power supply	Input measured voltage	Current transformer (sold separately)	Model No.	
KW1M (Standard type)	Single-phase two-wire system Single-phase three-wire system Three-phase three-wire system	100 to 240 V AC 50 / 60 Hz	100 / 200 V AC system	Dedicated type 5 A, 50 A, 100 A, 250 A, 400 A and 600 A	AKW1110	
KW1M-H (SD memory card type)	Three-phase four-wire system (Note 1)		100 / 200 / 400 V AC system (Select with setting mode)		AKW1111 AKW1121	
KW1M-R Built-in wireless type	Master unit (Note 2, 3)		—	—	—	AKW1000
	Slave unit		Single-phase two-wire system Single-phase three-wire system Three-phase three-wire system Three-phase four-wire system	100 / 200 / 400 V AC system (Select with setting mode)	Dedicated type 5 A, 50 A, 100 A, 250 A, 400 A and 600 A	AKW1131

Notes: 1) For a three-phase four-wire system, exclude **AKW1110** from the selection.

2) **AKW1000** can serve as either a “master unit” or a “slave unit (as a repeater)” by being selected in the master unit/slave unit setting mode (MODE 1).

3) **AKW1000** does not have a power measurement function.

MEASUREMENT ITEMS (Not applicable for AKW1000)

Item	Unit	Data display range
Instantaneous electric power (Active)	kW	0.00 to 9999.99
Integrated electric power (Active)	kWh/MWh	0.00 to 9999.99 MWh
		0.00 to 9999999.99 kWh (when 9-digit display)
Current	R-current	A
	S-current (Note 1)	A
	T-current	A
Voltage	R (RS)-voltage	V
	S (RT)-voltage (Note 1)	V
	T (TS)-voltage	V
Electricity charge (Note 2)	—	0.00 to 999999
Conversion carbon dioxide value	kg-CO ₂	0.00 to 999999
Power factor (Note 1)	—	0.00 to 1.00 [Identify leading phase (–) or lagging phase] (Only in range of phase angle $\theta = -90^\circ$ to $+90^\circ$)
Frequency (Note 1)	—	47.5 to 63.0 Hz
Hour meter	ON-time	h (Hour)
	OFF-time	h (Hour)
Pulse count value (Note 1)	—	0 to 999999

Notes: 1) Excluding **AKW1110**

2) Eco-POWER METER is designed chiefly to manage saving energy. It is neither intended nor can it be legally used for billing.

SPECIFICATIONS

For details, please refer to the Eco-POWER METER user's manual.

Main unit specifications

Item	Specifications
Rated operating voltage	100 to 240V AC
Rated frequency	50 / 60 Hz common
Rated power consumption	6 VA (AKW1110), 8 VA (AKW1111, AKW1121 and AKW1131), 5 VA (AKW1000) (240 V AC at 25 °C 77 °F)
Allowable operating voltage range	85 to 264 V AC (85 % to 110 % of rated operating voltage)
Allowable momentary power-off time	10 ms
Ambient temperature	-10 to +50 °C 14 to 122 °F (-25 to +70 °C -13 to +158 °F) at storage
Ambient humidity	30 to 85 % RH (at 20 °C 68 °F), non-condensing

Wireless specifications (for AKW1000 and AKW1131)

Item	Specifications
Wireless system type	Direct sequence spread spectrum (DS-SS)
Communication distance	100 m 328 ft (Obstacle-free straight-line distance)
Radio wave output	1 mW
Frequency band	2,405 to 2,480 MHz
Number of channels	16 channels (The auto-scanning function can automatically select an unassigned channel.)
Wireless transmission speed	250 kbps
Communication style	1 : N communication, Auto routing system (N: Up to 247 units)
Repeater function	Number of repeaters: 8 repeaters (between the master unit and the target slave unit) (Note)

Note: Since the unit does not have a repeater setting function, use the dedicated tool "KW Network Monitor" to check the actual number of repeaters.

Pulse input specifications (for AKW1111, AKW1121 and AKW1131)

Item	Specifications	
Input mode	Addition (Fixed)	
Max. counting speed	2 kHz / 30 Hz (Select with setting mode)	
Pulse input (Min. input signal width)	0.25 ms (When 2 kHz selected) / 16.7 ms (When 30 Hz selected), ON : OFF ratio = 1 : 1	
Input signal (at 20 °C 68 °F)	Contact / No voltage contact (open collector) • Impedance when shorted: Max. 1 kΩ • Residual voltage when shorted: Max. 2 V • Impedance when open: Min. 100 kΩ	
Mode	HOLD (Over count)	
Prescale	Decimal point	Setting possible up to under 3-digit
	Range	0.001 to 100.000 (Set with setting mode)

Communication specifications

Item	Specifications	
	RS232C communication (for AKW1000 only)	RS485 communication
Protocol	MEWTOCOL and MODBUS (RTU) (Note 5)	MEWTOCOL and MODBUS (RTU) (Note 5) (Note 6) (selectable with setting mode)
Isolation status	—	Isolated with the internal circuit
Number of connected units	—	Max. 99 units (Note 2, 3)
Transmission distance / Transmission speed	15 m 49 ft / 115,200, 57,600, 38,400, 19,200, 9,600, 4,800, 2,400 or 1,200 bps (selectable with setting mode)	1,200 m 3,937 ft (Note 1) / 38,400, 19,200, 9,600, 4,800 or 2,400 bps For AKW1000: 115,200, 57,600, 38,400, 19,200, 9,600, 4,800, 2,400 or 1,200 bps (selectable with setting mode)
Transmission format	Data length: 8-bit / 7-bit (selectable with setting mode) (Note 4), Parity: Not available / Odd number / Even number (selectable with setting mode), Stop bit: 1 bit (fixed)	
Communication method / Synchronous system	Half-duplex / Synchronous communication method	
Flow control	Enable / Disable (selectable with setting mode) (If you enable the flow control function, the counterpart equipment must also be compatible with flow control.)	—
Ending resistance	—	120 Ω approx. (built-in)
Data buffer (Max. data byte size for send and receive one time)	MEWTOCOL: 2,048 bytes, MODBUS (RTU): 256 bytes	MEWTOCOL: 2,048 bytes (Note 7), MODBUS (RTU): 256 bytes (Note 7)

Notes: 1) Please check with the actual devices when some commercial devices with RS485 interface are connected. The number of connected devices, transmission distance, transmission speed may be different according to using devices or transmission line.
2) For RS485 converter on the computer side, we recommend SI-35 and SI-35USB (from LINE EYE Co., Ltd.).
3) When using SI-35, SI-35USB or our PLC (which can be connected up to 99 units), up to 99 Eco-POWER METER units can be connected. (However, 32 units max. using connection with C-NET adapter) In case using this system with the other devices, up to 31 Eco-POWER METER units can be connected.
4) With MODBUS (RTU) protocol for RS485 communication, it works only with data length 8-bit. 5) You don't have to select a protocol for the 1:1 communications of AKW1000 (only if both units are AKW1000).
6) AKW1131 cannot be used for data communications via RS485. It may result in malfunction.
7) Command sending to/receiving from an AKW1131 station: Max. reading: 26 points (57 bytes), Max. writing: 23 points (55 bytes)
* Modbus Protocol is a communications protocol developed for PLCs by Modicon Inc.

Memory specifications of main unit (for AKW1121)

Item	Specifications	
File type 1 (instantaneous value)	Save cycle	60 min (on the hour) (fixed)
	Save data	(Instantaneous value) Integrated electric power, Instantaneous electric power, Current, Voltage, Power factor, Frequency, and Count value
	Save data amount	24 records per file (max. approx. 1.5 years worth of data)
File type 2 (difference value)	Save cycle	60 min (on the hour) (fixed)
	Save data	(Difference value) Integrated electric power and Count value
	Save data amount	24 records per file (max. approx. 1.5 years worth of data)
File type 3 (instantaneous value detail)	Save cycle	Select among 1 min, 5 min, 10 min, 15 min, 30 min, or 60 min (Saved timing) When 1 min is selected: 00 sec after the minute When 5 min is selected: 00, 05, 10, 15, 20, 25, 30... min after the hour When 10 min is selected: 00, 10, 20, 30, 40, 50 min after the hour When 15 min is selected: 00, 15, 30, 45 min after the hour When 60 min is selected: 00 min after the hour
	Save data	Integrated electric power, Instantaneous electric power, Current, Voltage, Power factor, Frequency, and Count value
	Save data amount	Max. 5,760 records, 4 days approx. period (when the save cycle is set to one minute)
	Main unit display	Integrated electric power by month (latest data covering 1.5 year period) / Integrated electric power by day (latest data covering 1 month period) / Integrated electric power by hour (latest data covering 24 hours period)

Item	Specifications
Display method	LCD with backlight Upper: green, 4-digit, 16-segment Lower: amber, 6-digit, 7-segment
Power failure memory method	AKW1000 FROM (more than 100,000 overwrite) AKW1110, AKW1111, AKW1112 and AKW1131 EEPROM (more than 100,000 overwrite)
Weight	170 g approx. (AKW1110 and AKW1111), 180 g approx. (AKW1121), 160 g approx. (AKW1000), 170 g approx. (AKW1131) * Excluding the antenna and battery

Electric power input specifications NEW Improved measurement accuracy

Item	Specifications	
Accuracy (without error in CT and VT)	Integrated electric power and instantaneous electric power	Within ± (2.0 % F.S. + 1 digit) (at 20 °C 68 °F, rated input, rated frequency, power factor 1) Accuracy coverage: 5 to 100 % of rated current
	Current	Within ± (1.0 % F.S. + 1 digit) (at 20 °C 68 °F rated input, rated frequency, power factor 1) Accuracy coverage: 5 to 100 % of rated current
	Voltage	Within ± (1.0 % F.S. + 1 digit) (at 20 °C 68 °F rated input, rated frequency, power factor 1)
	Hour meter	Within ± (0.01 % + 1 digit) (at 20 °C 68 °F) [In case power on start or current energizing: within ± (0.01 % + 1 sec + 1 digit) (at 20 °C 68 °F)]
	Temperature characteristics	Within ± (1.0 % F.S. + 1 digit) (Range of -10 to 50 °C 14 to 122 °F, rated input, power factor 1)
	Frequency characteristics	Within ± (1.0 % F.S. + 1 digit) (Frequency change ± 5 % based on rated frequency, rated input, power factor 1)

Specifications of the pulse output (transistor output) of integrated electric active power

Item	Specifications
Number of output point	1 point
Insulation method	Optical coupler
Output type	Open collector
Output capacity	100 mA 30 V DC
Pulse width	100 ms approx.
ON state voltage drop	1.5 V or less
OFF state leakage current	100 μA or less
Pulse output unit (selectable with setting mode) (Note 3)	0.001 kWh, 0.01 kWh, 0.1 kWh, 1 kWh, 10 kWh, 100 kWh / Power alarm (AL-P) / Current alarm (AL-C) / Stand-by power alarm (AL-S) (Note 1) / Counter output (Cnt) (Note 1) / Demand alarm (OEM) (Note 2)

Notes: 1) For AKW1111, AKW1121, and AKW1131 2) For AKW1121 only
3) We recommend the setting of minimum unit for pulse output for measurement shown as below.
Output pulse: 4 pulses or less per 1sec
Count errors may occur if pulse output unit is set so that 4 or more pulses are output per 1 second.
- How to calculate -
Unit for pulse output: PL-P > Max. measurement power (kW) / 3,600 sec × 4 pulse/sec

External memory specifications

<SD memory card slot> (for AKW1121 only)

Item	Specifications
Support media	SD memory card (Note 1)
Supported format standards	Compliant with SD and SDHC standards (Note 2)

Notes:
1) Operation verified maker: Panasonic Corporation SD/SDHC memory card 2 GB, 4 GB and 8 GB
2) To format SD memory cards, please download and use the formatting software available on the Panasonic website. The file system on a SD memory card that was formatted using standard PC software does not comply with the SD memory card standard.

Calendar timer specifications (for AKW1000 and AKW1121)

Item	Specifications
Time accuracy	Monthly accuracy: ± 240 sec (at -10 °C 14 °F) Monthly accuracy: ± 70 sec (at 25 °C 77 °F) Monthly accuracy: ± 240 sec (at 50 °C 122 °F)
Content of battery backup	Time measurement and log data (for AKW1121)
Battery life	2 years approx. (at ambient temperature 25 °C 77 °F) (in power-off state)

< SD memory card handling precautions >

Data saved on an SD memory card may be lost in the following cases. Please note that Panasonic Industrial Devices SUNX is not responsible for any losses of recorded data and other direct and indirect damages.

- When a user or a third party incorrectly uses the SD memory card
- When the SD memory card is affected by static electricity or electrical noise
- When the SD memory card is taken out or the power is turned off while the SD memory card access LED of the unit is flashing (during data writing)

* It is recommended that you constantly back up important data to another medium.

KW4M / KW7M / KW8M

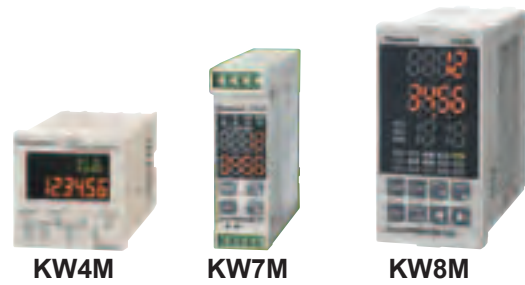

FEATURES

Features of KW4M

- Easy on-panel mounting with included mounting frame.
- Protective structure: IEC IP66 (Only the panel front with rubber gasket).
- UL-compliant.
- NEW** • Measurement of inverter power supplies (primary side) is available.

Features of KW7M

- DIN rail type ideal for installation in a panel.
- Slim, 22.5 mm **0.89 in** wide: easily mounts anywhere.
- NEW** • Measurement of inverter power supplies (primary side) is available.

Common Features of KW8M

- Compatible with systems of up to three-phase four-wire.
- Easy on-panel mounting with included mounting frame.
- NEW** • Measurement of inverter power supplies (primary side) is available.

KW8M High performance type

- Log data is stored to memory of main unit.
- Built-in battery (for clock and log data backup).
- Simple demand function.

KW8M 1 A / 5 A CT input type

- Capable of direct input from 1 A / 5 A CT in the secondary side without using dedicated CT.
- High current circuit measurement.

ORDER GUIDE

Product name	Protocol	Phase and wire system	Input measured voltage	Current transformer (sold separately)	Terminal type	Model No.
KW4M Eco-POWER METER DIN □48 type	MEWTOCOL	Single-phase two-wire system Single-phase three-wire system Three-phase three-wire system	100 / 200 V AC system	Dedicated type 5 A, 50 A, 100 A, 250 A and 400 A	Screw terminal	AKW5111
	MODBUS (RTU)					AKW5112
	MEWTOCOL				11-pin	AKW5211
	MODBUS (RTU)					AKW5212
KW7M Eco-POWER METER DIN rail type		Single-phase two-wire system Single-phase three-wire system Three-phase three-wire system	100 / 200 V AC system		Screw terminal (M3 / M2 screw)	AKW7111
KW8M Eco-POWER METER DIN 48 × 96 type		Single-phase two-wire system Single-phase three-wire system Three-phase three-wire system Three-phase four-wire system	100 / 200 / 400 V AC system (Select with setting mode)	Dedicated type 5 A, 50 A, 100 A, 250 A, 400 A and 600 A	Screw terminal (M3 "+ / -" screw)	AKW8111
	High performance type					AKW8111H
	1 A / 5 A CT input type					AKW8115 (Note)

Note: Since a dedicated CT is not used, please use a 4,000 A or less type (secondary current: 1 A or 5 A).

MEASUREMENT ITEMS

KW4M		
Item	Unit	Data display range
Instantaneous electric power	kW	0.00 to 9999.99
Integrated electric power	kWh	0.00 to 9999.99 kWh and after
	MWh	10.00 MWh to 9999.99 MWh When 9-digit display: 0.00 to 9999999.99 kWh
Current	L1 (CT1) - phase current	A 0.0 to 6000.0
	L2 (CT2) - phase current	A 0.0 to 6000.0
Voltage	Voltage between 1-2	V 0.0 to 9999.9
	Voltage between 2-3	V 0.0 to 9999.9
Electricity charge (Note)	Yen	JPY 0 to 999999
	Dollars	\$ 0.0 to 99999.9
	Euros	EUR 0.0 to 99999.9
	Yuan	CNY 0 to 999999
	No currency	CHG 0 to 999999
Conversion carbon dioxide value	kg-CO ₂	0.0 to 999999
Hour meter	ON-time	h (Hour) 0.0 to 99999.9
	OFF-time	h (Hour) 0.0 to 99999.9
Pulse count value	Count	0 to 999999

KW7M		
Item	Unit	Data display range
Instantaneous electric power	kW	0.00 to 999999.99
Integrated electric power	kWh	0.00 to 9999999.9
Current	L1 (CT1) - phase current	A 0.0 to 6000
	L2 (CT2) - phase current	A 0.0 to 6000
Voltage	Voltage between 1-2	V 0.0 to 9999
	Voltage between 2-3	V 0.0 to 9999
Electricity charge (Note)		0.00 to 99999999

KW8M			
Item	Unit	Data display range	
Integrated electric power	Active	kWh	0.00 to 9999999.9
	Reactive	kvarh	0.00 to 9999999.9
	Apparent	kVAh	0.00 to 9999999.9
Instantaneous electric power	Active	kW	0.00 to 9999999.99
	Reactive	kvar	-99999.99 to 0.00 to 999999.99
	Apparent	kVA	0.00 to 9999999.99
Current	CT1 - phase current	A	0.0 to 6000
	CT2 - phase current	A	0.0 to 6000
	CT3 - phase current	A	0.0 to 6000
Voltage	Voltage between P1 and P0	V	0.0 to 9999
	Voltage between P2 and P0	V	0.0 to 9999
	Voltage between P3 and P0	V	0.0 to 9999
Electricity charge (Note)	-		0.0 to 99999999
Power factor	Displayed on the main unit		0.00 to 1.00 [with identify leading phase (LEAD) or lagging phase (LAG)]
	Communication		-1.00 to 0.00 to 1.00 (Only in range of phase angle $\theta = -90^\circ$ to $+90^\circ$)
Frequency		Hz	47.5 to 63.0
Hour meter	ON-time	Time	0.0 to 99999.9
	OFF-time		
Pulse count value	-		0.0 to 99999999

Note: Eco-POWER METER is primarily designed to manage saving energy. It is neither intended nor can it be legally used for billing.

SPECIFICATIONS

For details, please refer to the Eco-POWER METER user's manual.

KW4M

Main unit specifications

Item	Specifications
Rated operating voltage	100 to 120 V AC / 200 to 240 V AC
Rated frequency	50 / 60 Hz common
Rated power consumption	8 VA (240 V AC at 25 °C 77 °F)
Allowable operating voltage range	85 to 132 V AC / 170 to 264 V AC (85 % to 110 % of rated operating voltage)
Allowable momentary power-off time	10 ms
Ambient temperature	-10 to +50 °C 14 to 122 °F (-25 to +70 °C -13 to +158 °F) at storage
Ambient humidity	30 to 85 % RH (at 20 °C 68 °F), non-condensing
Vibration resistance	10 to 55 Hz (1cycle / min), single amplitude: 0.75 mm 0.03 in (1 hour on 3 axes)
Shock resistance	Min. 294 m/s ² (5 times on 3 axes)
Display method	6-digit, 7-segment (set value) with backlight and 4-digit, 16-segment (mode), LCD upper section: green, lower section: amber
Power failure memory method	EEPROM (more than 100,000 overwrite)
Protection	IEC standard IP66 (only front panel with rubber gasket) * Mounted in a row, waterproofing property will be lost.
Weight	140 g approx. (screw terminal type), 130 g approx. (11-pin type)

KW7M

Main unit specifications

Item	Specifications
Rated operating voltage	100 to 120 V AC / 200 to 240 V AC
Rated frequency	50 / 60 Hz common
Rated power consumption	6 VA (240 V AC at 25 °C 77 °F)
Allowable operating voltage range	85 to 132 V AC / 170 to 264 V AC (85 % to 110 % of rated operating voltage)
Allowable momentary power-off time	10 ms
Ambient temperature	-10 to +50 °C 14 to 122 °F (-25 to +70 °C -13 to +158 °F) at storage
Ambient humidity	30 to 85 % RH (at 20 °C 68 °F), non-condensing
Vibration resistance	10 to 55 Hz (1cycle / min), single amplitude: 0.375 mm 0.01 in (1 hour on 3 axes)
Shock resistance	Min. 294 m/s ² (5 times on 3 axes)
Display method	8-digit, 7-segment LED
Power failure memory method	EEPROM (more than 100,000 overwrite)
Weight	100 g approx.

KW8M

Main unit specifications

Item	Specifications
Rated operating voltage	100 to 240 V AC
Rated frequency	50 / 60 Hz common
Rated power consumption	8 VA (240 V AC at 25 °C 77 °F)
Allowable operating voltage range	85 to 264 V AC (85 % to 110 % of rated operating voltage)
Allowable momentary power-off time	10 ms
Ambient temperature	-10 to +50 °C 14 to 122 °F (-25 to +70 °C -13 to +158 °F) at storage
Ambient humidity	30 to 85 % RH (at 20 °C 68 °F), non-condensing
Vibration resistance	10 to 55 Hz (1cycle / min), single amplitude: 0.375 mm 0.01 in (1 hour on 3 axes)
Shock resistance	Min. 294 m/s ² (5 times on 3 axes)
Display method	8-digit, 7-segment LED
Power failure memory method	EEPROM (more than 100,000 overwrite)
Weight (without mounting bracket)	235 g approx. (AKW8111), 250 g approx. (AKW8111H high performance type), 265 g approx. (AKW8115 1 A / 5 A CT input type)

Note: Analog input terminals: No. 11 to 20 / Pulse input terminals: No. 4 and 5

KW4M / KW7M / KW8M

Electric power input specifications **NEW** Improved measurement accuracy

Item	Specifications	
Accuracy (without error in CT and VT)	Integrated electric power and Instantaneous electric power	Within ± (2.0 % F.S. + 1 digit) (at 20 °C 68 °F, rated input, rated frequency, power factor 1) (Note 1) Accuracy coverage: 5 to 100 % of rated current
	Current	Within ± (1.0 % F.S. + 1 digit) (at 20 °C 68 °F rated input, rated frequency, power factor 1) Accuracy coverage: 5 to 100 % of rated current
	Voltage	Within ± (1.0 % F.S. + 1 digit) (at 20 °C 68 °F rated input, rated frequency, power factor 1)
	Hour meter (Note 2)	Within ± (0.01 % + 1 digit) (at 20 °C 68 °F) [In case power on start or current energizing: Within ± (0.01 % + 1 sec + 1 digit) (at 20 °C 68 °F)]
	Temperature characteristics	Within ± (1.0 % F.S. + 1 digit) (Range of -10 to +50 °C 14 to 122 °F, rated input, power factor 1)
	Frequency characteristics	Within ± (1.0 % F.S. + 1 digit) (Frequency change ± 5 % based on rated frequency, rated input, power factor 1)

Notes: 1) Integrated electric power (active/apparent) and instantaneous electric power (active/apparent) of **AKW8115**: within ± (1.0 % F.S. + 1 digit) (at 20 °C 68 °F, rated input, rated frequency, power factor 1)
Accuracy coverage: 5 to 100 % of rated current2) Excluding **KW7M**

DEDICATED CURRENT TRANSFORMER (CT) AND OPTIONS

DEDICATED CURRENT TRANSFORMER (CT)



ORDER GUIDE (Dedicated CT cannot be used with the AKW8115.)

Primary side rated current		Model No.
Clamp-on type	5 A/50 A	AKW4801C
	100 A	AKW4802C
	250 A	AKW4803C
	400 A	AKW4804C
Through type	50 A/100 A	AKW4506C
	250 A/400 A	AKW4507C
	600 A	AKW4508C (Note 2)



- Notes: 1) For except **AKW8115**, please order in accordance with the type of power distribution system you will be measuring. (Even if you will be using a secondary side 5 A CT, you will need an **AKW4801C**.)
 2) **AKW4508C** can be used with an Eco-POWER METER compatible with 600 A type CT.

Specifications

Item	Type	Clamp-on type				Through type			
	Model No.	AKW4801C	AKW4802C	AKW4803C	AKW4804C	AKW4506C	AKW4507C	AKW4508C	
Primary side rated current		5 A/50 A	100 A	250 A	400 A	50 A/100 A	250 A/400 A	600 A	
Secondary side rated current		1.67 mA/16.7 mA	33.3 mA	125 mA	200 mA	16.7 mA/33.3 mA	125 mA/200 mA	200 mA	
Winding (Turn)		3,000	3,000	2,000	2,000	3,000	2,000	3,000	
Ratio error		± 2.0% F.S.				± 1.0% F.S.			
Through hole		ø10 mm ø0.39 in	ø16 mm ø0.63 in	ø24 mm ø0.94 in	ø36 mm ø1.42 in	ø17 mm ø0.67 in	ø36 mm ø1.42 in		
Breakdown voltage (initial)		1,000 V AC / 1 min (Between through hole and output lead wire)		2,000 V AC / 1 min (Between through hole and output lead wire)		1,000 V AC / 1 min (Between through hole and output lead wire)		2,000 V AC / 1 min (Between through hole and output lead wire)	
Insulation resistance (initial)		Min. 100 MΩ (at 500 V DC megger) (Between through hole and output lead wire)							
Functional vibration resistance		10 to 55 Hz (1 cycle / min), single amplitude: 0.15 mm 0.01 in (10 min on 3 axes)							
Vibration resistance		10 to 55 Hz (1 cycle / min), single amplitude: 0.375 mm 0.01 in (1 hour on 3 axes)							
Functional shock resistance		Min. 98 m/s ² (4 times on 3 axes)							
Shock resistance		Min. 294 m/s ² (5 times on 3 axes)							
Output protection level		± 7.5 V with clamp element		± 3.0 V with clamp element		± 7.5 V with clamp element		± 3.0 V with clamp element	
Permissible clamping frequency		100 times approx.					—		
Ambient temperature range		-10 to +50 °C +14 to +122 °F (without frost and non-condensing)							
Storage temperature		-20 to +60 °C -4 to +140 °F (without frost and non-condensing)							
Ambient humidity		35 to 85 % RH (at 20 °C 68 °F non-condensing)							
Weight (Trunk cable included)		60 g approx.	90 g approx.	200 g approx.	295 g approx.	70 g approx.	200 g approx.	215 g approx.	

- Notes: 1) Dedicated CT are dedicated for low voltage under 440 V AC system. They can not be used for high voltage circuit.
 2) In each type of Eco-POWER METER excluding **AKW8115**, a combination of commercially secondary side 5 A CTs and dedicated CTs for 5 A (**AKW4801C**) is used for measuring high voltage circuits; therefore, **AKW4801C** is definitely necessary. For details, confirm with each respective user's manual.
 3) Since dedicated CTs cannot be used when measuring with **AKW8115**, please be careful and do not purchase a dedicated CT by mistake.
 4) For the **AKW8115** CT, current transformers manufactured by U.R.D. Co., Ltd. (clamp-on type CT CTL-CL series) are recommended. Please confirm the specification beforehand.
 5) Dedicated CT are not included with Eco-POWER METERS.
 6) Each dedicated CT includes a 1 m **3.3 ft** trunk cable, respectively.

OPTIONS

Trunk cable



Product name	Model No.	
Trunk cable for CT (Option of Eco-POWER METER dedicated CT)	3 m 9.8 ft	AKW4703
	5 m 16.4 ft	AKW4705
	10 m 32.8 ft (special order)	AKW4710

Note: For any type of trunk cable, please connect no more than one.

Intermediate power cable

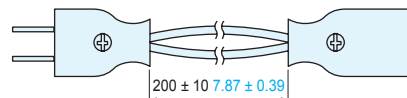

Product name	Model No.
Intermediate power cable	AKE2811

Note: We recommend using an intermediate power cable when attaching the dedicated CT to a non-"Y" split power cable.

Antenna with cable: For KW1M-R



Pencil type antenna: For KW1M-R



Antenna extension cable: For KW1M-R (Note)

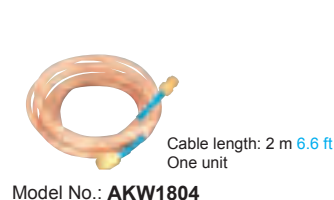

RS232C cable: For KW1M-R (master unit)



Note: When an antenna extension cable is used, radio wave attenuation occurs. With a single extension cable, the communications distance is reduced by about 30 %: use only after prior confirmation that the system is functioning effectively.

Required for installation inside switchboard

Mounting rails (applicable for DIN and IEC standards):
For KW4M pin type (AKW5211 and AKW5212), KW7M, KW2G / KW2G-H, and KW1M / -H / -R

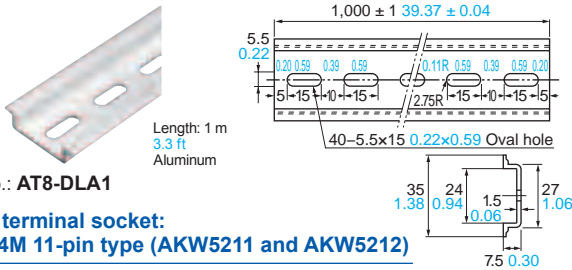

Model No.: **AT8-DLA1**

DIN rail terminal socket:
For KW4M 11-pin type (AKW5211 and AKW5212)

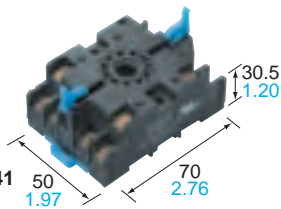

Model No.: **ATC180041**

Fastening plate:
For KW4M pin type (AKW5211 and AKW5212), KW7M, KW2G / KW2G-H, and KW1M / -H / -R

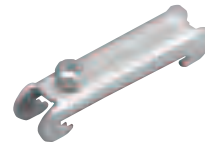

Model No.: **ATA4806**

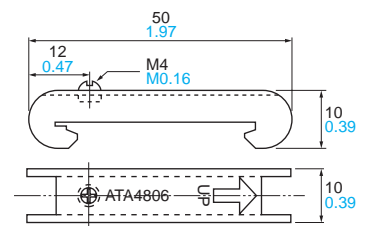

* For holding DIN rails

Required for installation on control panel

Rear terminal socket:
For KW4M 11-pin type (AKW5211 and AKW5212)

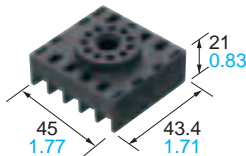

Model No.: **AT78051**

11-pin cap:
For KW4M 11-pin type (AKW5211 and AKW5212)

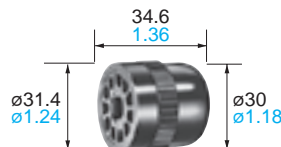

Model No.: **AT8-DP11**

Mounting frame:
For KW1M and KW1M-H

* Sold separately

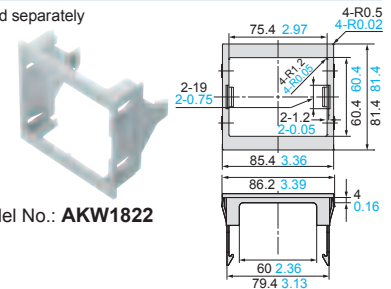

Model No.: **AKW1822**

Convenient when installation is on control panel.

Protective cover for DIN 48 size (flexible type) : For KW4M

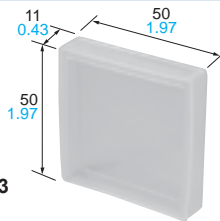

Model No.: **AQM4803**

Terminal protective cover: For KW4M screw terminal type (AKW5111 and AKW5112)



Model No.: **AKW4823**

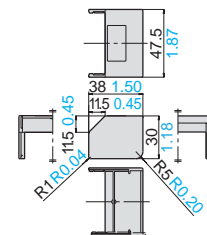

Mounting frame: For KW4M * For fixing

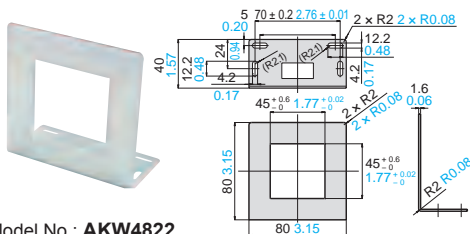

Model No.: **AKW4822**

Mounting frame: For all types KW8M

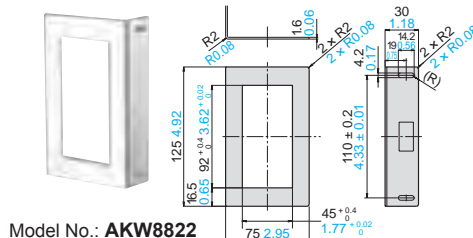

Model No.: **AKW8822**

Terminal cover: For all types KW8M

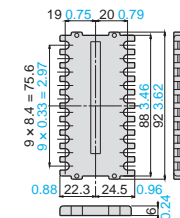

Model No.: **AKT8801**

Others

Screwdriver for terminal socket: For KW7M

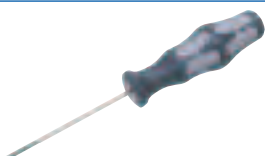

Model No.: **AFP0806**

Backup battery: For KW1M-H, KW1M-R (master unit) and KW2G-H main unit

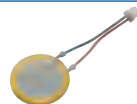

* Packaged with **AKW1000, AKW1121 and AKW2020G**

Model No.: **AFPG804**

Backup battery: For high performance type KW8M (AKW8111H) only



* Packaged with the main unit

Model No.: **AFC8801**

DIMENSIONS

Unit: mm in, Tolerance: $\pm 1.0 \pm 0.04$

KW2G (Standard type) and KW2G-H (SD memory card type)

(Main unit) AKW2010G / AKW2020G

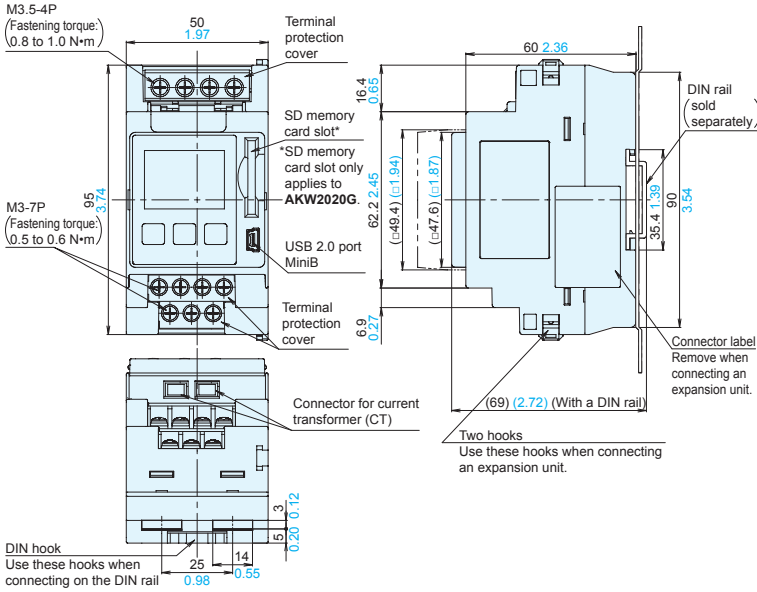

Terminal arrangement (for AKW2010G / AKW2020G)

Terminal No.	Function	Terminal type
(1)	P1	M3.5 "+ / -" screw
(2)	P0	
(3)	P2	
(4)	NC	
(5)	+	Pulse output
(6)	-	
(7)	+	Pulse input
(8)	-	
(9)	+	M3 "+ / -" screw
(10)	-	
(11)	E	

⚠ The input voltage to each terminal is as follows.

Terminal	Phase and wire system	Between terminals	Input voltage
Measured voltage input	Single-phase two-wire system	(1)-(2) (P1-P0)	100 to 240 V AC (100 to 240 V and after) (Line voltage)
	Single-phase three-wire system	(1)-(2)-(3) (P1-P0-P2)	100 to 120 V AC (100 to 120 V and after: 3W) (Phase voltage)
	Three-phase three-wire system	(1)-(2)-(3) (P1-P0-P2)	100 to 240 V AC (100 to 240 V 3 and after) (Line voltage)

Terminal arrangement (for AKW2160G)

Terminal No.	Function	Terminal type
(1)	+	M3
(2)	-	

Terminal arrangement (for AKW2152G)

Terminal No.	Function	Terminal type
(1)	CH0	+
(2)		-
(3)	CH1	+
(4)		-

* The "-" terminals are connected internal. (Between channels: non-isolated)

Terminal arrangement (for AKW2182G)

Terminal No.	Function	Terminal type
(1)	CH0	V/I
(2)		COM
(3)	CH1	V/I
(4)		COM

* The "COM" (common) terminals are connected internal. (Between channels: non-isolated)

(Expansion unit) AKW2110G / AKW2160G / AKW2152G / AKW2182G

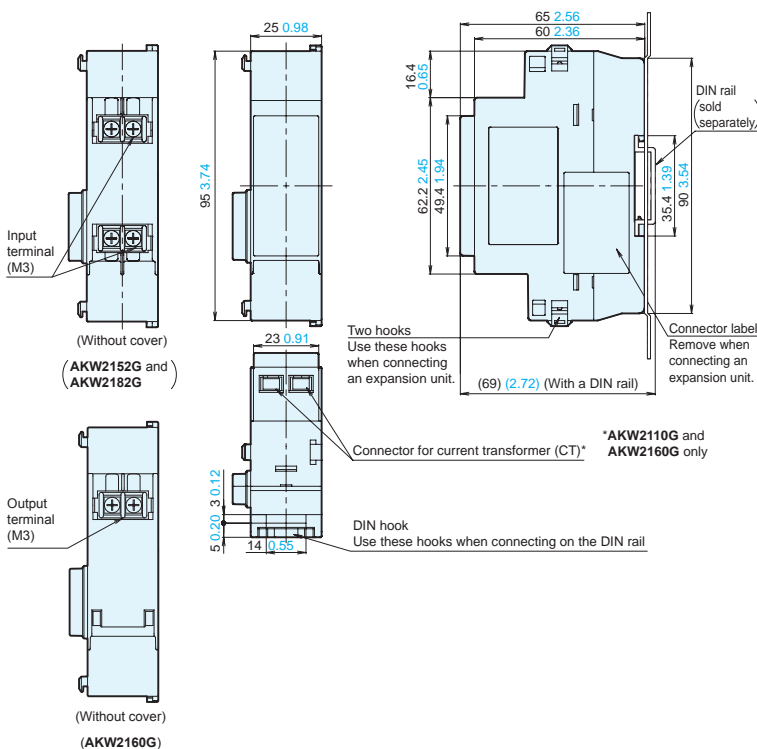

<Wiring diagrams>

Single-phase two-wire system

* One dedicated CT is required for one load.

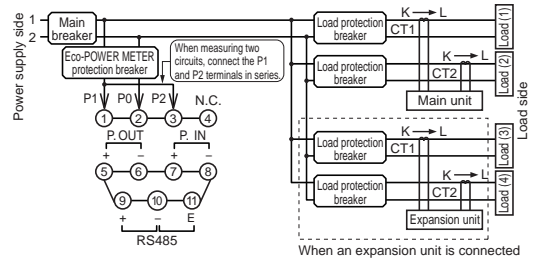

Single-phase three-wire system / Three-phase three-wire system

* Two dedicated CT are required for one load.

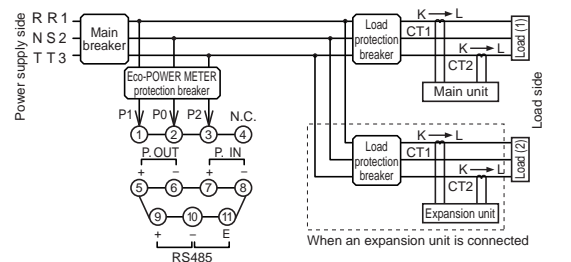

- Be sure to wire correctly according to the terminal arrangement and wiring diagrams.
- For details, please refer to the Eco-POWER METER user's manual.

Unit: mm in, Tolerance: $\pm 1.0 \pm 0.04$

KW1M-R Built-in wireless type

(Master unit) AKW1000

Mounting hole dimensions

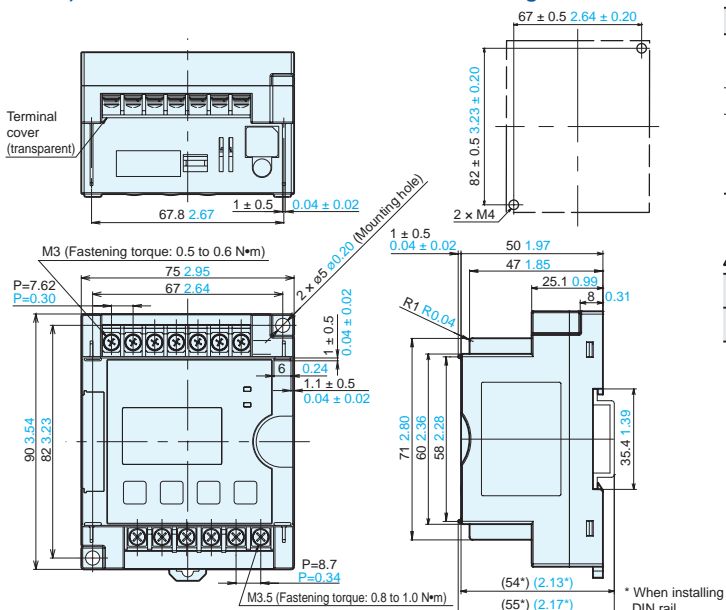

Terminal arrangement

Function	Terminal type	Terminal No.	Terminal type	Function
Operating power supply	L	(1)	(7)	+
	N	(2)	(8)	
No connection	M3.5 screw	(3)	(9)	E
		(4)	(10)	+
		(5)	(11)	
RS232C	SD	(6)	(12)	No connection
	RD	(11)	(13)	
	SG	(12)	(13)	
				RS
				CS
				RS232C

⚠ The input voltage to each terminal is as follows.

Terminal	Phase and wire system	Between terminals	Input voltage
Operating power supply input	Single-phase two-wire	(1)-(2)	100 to 240 V AC (100 to 240 V and after) (Line voltage)

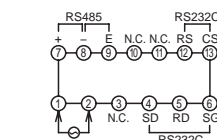

* Use a straight cable for RS232C connections.

(Slave unit) AKW1131

Mounting hole dimensions

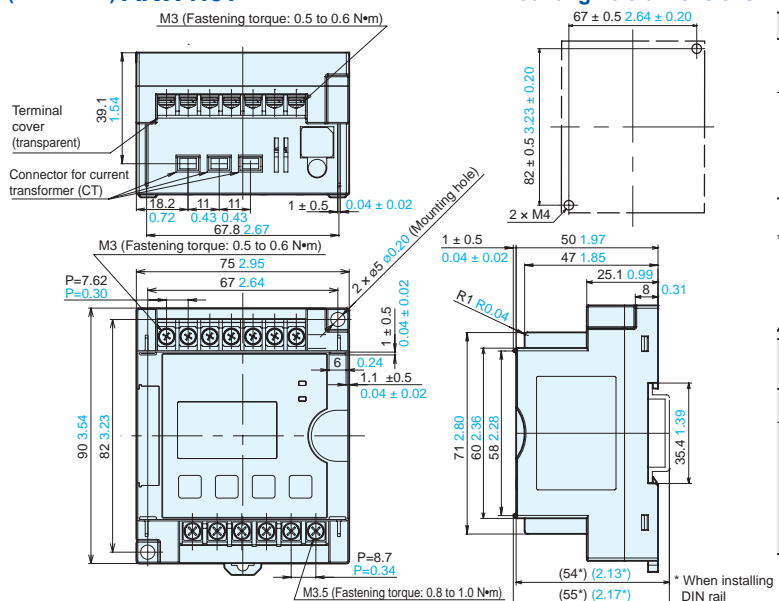

Terminal arrangement

Function	Terminal type	Terminal No.	Terminal type	Function	
Operating power supply	L	(1)	(7)	+	
	N	(2)	(8)		-
Measured voltage input	M3.5 screw	P1	(9)	+	
		P0	(4)		-
		P2	(5)		
P3	(6)	(12)	(11)	-	
					(13)
				-	
				Pulse output	
				Pulse input	

* Because the RS485(E) terminal does not have an SG (signal ground) terminal, the ground wire of the shielded cable should not be connected.

⚠ The input voltage to each terminal is as follows.

Terminal	Phase and wire system	Between terminals	Input voltage
Operating power supply input	Single-phase two-wire	(1)-(2)	100 to 240 V AC (100 to 240 V and after) (Line voltage)
	Single-phase two-wire	(3)-(4)	0 to 440 V AC (0 to 440 V and after) (Line voltage)
Measured voltage input	Single-phase three-wire	(3)-(4)-(5)	0 to 220 V AC (0 to 220 V to: 3W) (Phase voltage)
	Three-phase three-wire	(3)-(4)-(5)	0 to 440 V AC (0 to 440 V 3 and after) (Line voltage)
	Three-phase four-wire	(3)-(4)-(5)-(6)	0 to 254 V AC (0 to 254 V 3N and after) (Phase voltage)

<Wiring diagrams>

AKW1131 When measuring load with rated input voltage (100 to 200 V AC system and 400 V AC system)

Single-phase two-wire system *One dedicated CT is required.

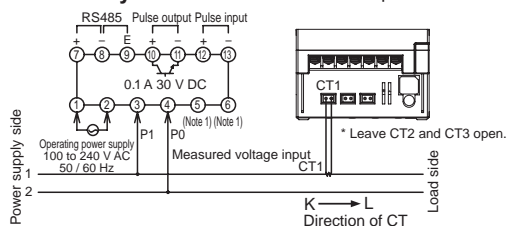

Three-phase four-wire system * Three dedicated CT are required.

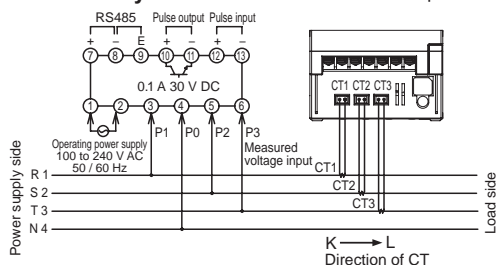

Single-phase three-wire system / Three-phase three-wire system

* Two dedicated CT are required.

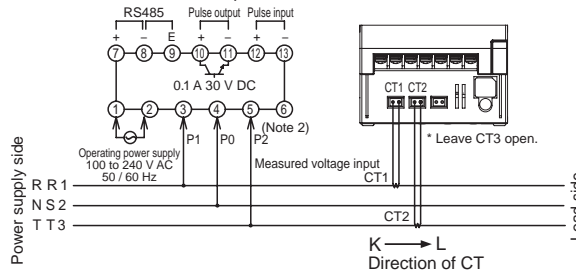

Notes: 1) Do not wire to (5), (6) terminal. They are connected internal.

2) Do not wire to (6) terminal. They are connected internal.

DIMENSIONS

Unit: mm in, Tolerance: $\pm 1.0 \pm 0.04$

KW1M (Standard type) and KW1M-H (SD memory card type)

AKW1110/AKW1111/AKW1121

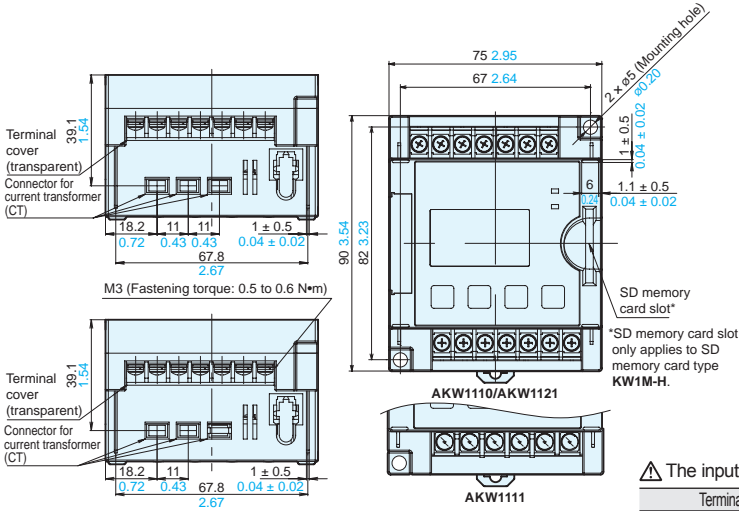

• For mounting hole dimensions, please refer to the KW1M-R "Mounting hole dimensions" on page 25.

Terminal arrangement (for AKW1110)

Terminal No.	Function	Terminal type
(1)	L	Operating power supply
(2)	N	
(3)	No connection	Measured voltage input
(4)	P1	
(5)	P0	
(6)	P2	RS485
(7) (Note 1)	No connection	
(8)	+	Pulse output
(9)	-	
(10) (Note 2)	E	Pulse input
(11)	+	
(12)	-	No connection
(13) (Note 1)	No connection	
(14) (Note 1)	No connection	

Notes: 1) The (7), (13) and (14) terminals are connected internal to analog input terminal. Cannot use extending wiring.
2) Because the RS485(E) terminal does not have an SG (signal ground) terminal, the ground wire of the shielded cable should not be connected.

⚠ The input voltage to each terminal is as follows. (for AKW1110)

Terminal	Phase and wire system	Between terminals	Input voltage
Operating power supply input	Single-phase two-wire	(1)-(2)	100 to 240 V AC (100 to 240 V and after) (Line voltage)
	Single-phase two-wire	(4)-(5)	0 to 220 V AC (0 to 220 V and after) (Line voltage)
Measured voltage input	Single-phase three-wire	(4)-(5)-(6)	0 to 110 V AC (0 to 110 V to: 3W) (Phase voltage)
	Three-phase three-wire	(4)-(5)-(6)	0 to 220 V AC (0 to 220 V 3 and after) (Line voltage)

<Wiring diagrams>

AKW1110 When measuring load with rated input voltage (100 to 200 V AC system)

Single-phase two-wire system *One dedicated CT is required.

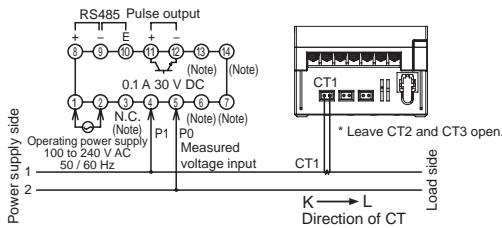

Note: Do not wire to (3), (6), (7), (13), (14) terminal. They are connected internal.

Single-phase three-wire system / Three-phase three-wire system * Two dedicated CT are required.

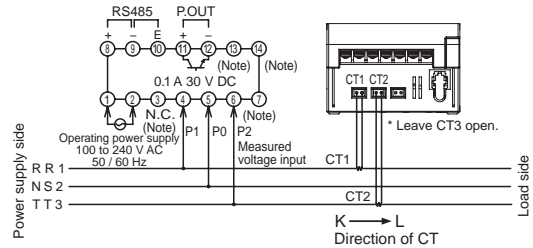

Note: Do not wire to (3), (7), (13), (14) terminal. They are connected internal.

AKW1111 When measuring load with rated input voltage (100 to 200 V AC system and 400 V AC system)

Single-phase two-wire system *One dedicated CT is required.

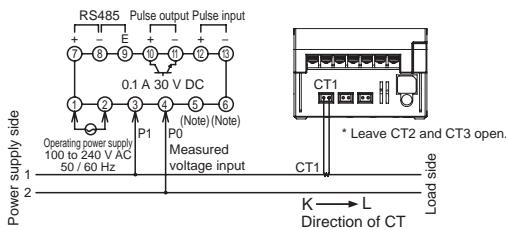

Note: Do not wire to (5), (6) terminal. They are connected internal.

Single-phase three-wire system / Three-phase three-wire system * Two dedicated CT are required.

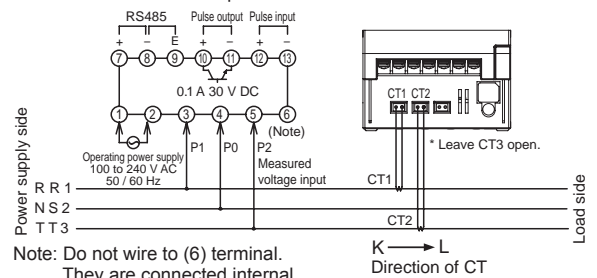

Note: Do not wire to (6) terminal. They are connected internal.

Three-phase four-wire system * Three dedicated CT are required.

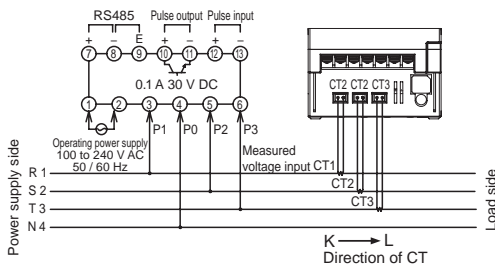

Terminal arrangement (for AKW1111)

Terminal No.	Function	Terminal type
(1)	L	Operating power supply
(2)	N	
(3)	P1	Measured voltage input
(4)	P0	
(5)	P2	
(6)	P3	RS485
(7)	+	
(8)	-	Pulse output
(9)	E	
(10)	+	Pulse input
(11)	-	
(12)	+	No connection
(13)	-	

* Because the RS485(E) terminal does not have an SG (signal ground) terminal, the ground wire of the shielded cable should not be connected.

⚠ The input voltage to each terminal is as follows.

Terminal	Phase and wire system	Between terminals	Input voltage
Operating power supply input	Single-phase two-wire	(1)-(2)	100 to 240 V AC (100 to 240 V and after) (Line voltage)
	Single-phase two-wire	(3)-(4)	0 to 440 V AC (0 to 440 V and after) (Line voltage)
Measured voltage input	Single-phase two-wire	(3)-(4)	0 to 220 V AC (0 to 220 V to: 3W) (Phase voltage)
	Single-phase three-wire	(3)-(4)-(5)	0 to 110 V AC (0 to 110 V to: 3W) (Phase voltage)
	Three-phase three-wire	(3)-(4)-(5)	0 to 220 V AC (0 to 220 V 3 and after) (Line voltage)
	Three-phase four-wire	(3)-(4)-(5)-(6)	0 to 254 V AC (0 to 254 V 3N and after) (Phase voltage)

AKW1121 When measuring load with rated input voltage (100 to 200 V AC system and 400 V AC system)

Single-phase two-wire system

*One dedicated CT is required.

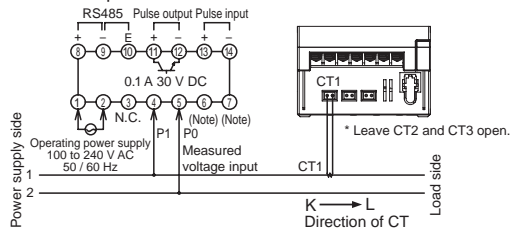

Note: Do not wire to (6), (7) terminal. They are connected internal.

Single-phase three-wire system / Three-phase three-wire system

* Two dedicated CT are required.

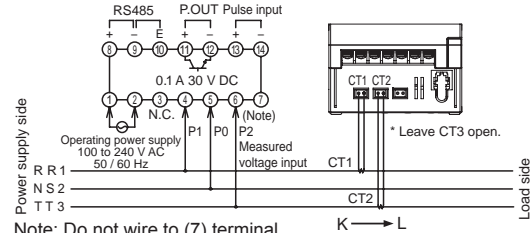

Note: Do not wire to (7) terminal. They are connected internal.

Three-phase four-wire system

* Three dedicated CT are required.

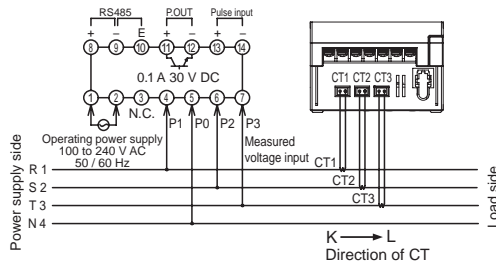

Terminal arrangement (for AKW1121)

No.	Function	Terminal type	No.	Function	Terminal type
(1)	L	M3 "+ / -" screw	(8)	+	M3 "+ / -" screw
(2)	N		(9)	-	
(3)	No connection		(10)	E	
(4)	P1	M3 "+ / -" screw	(11)	+	M3 "+ / -" screw
(5)	P0		(12)	-	
(6)	P2	M3 "+ / -" screw	(13)	+	M3 "+ / -" screw
(7)	P3		(14)	-	

* Because the RS485(E) terminal does not have an SG (signal ground) terminal, the ground wire of the shielded cable should not be connected.

⚠ The input voltage to each terminal is as follows.

Terminal	Phase and wire system	Between terminals	Input voltage
Operating power supply input	Single-phase two-wire	(1)-(2)	100 to 240 V AC (100 to 240 V and after) (Line voltage)
	Single-phase two-wire	(4)-(5)	0 to 440 V AC (0 to 440 V and after) (Line voltage)
Measured voltage input	Single-phase three-wire	(4)-(5)-(6)	0 to 220 V AC (0 to 220 V to: 3W) (Phase voltage)
	Three-phase three-wire	(4)-(5)-(6)	0 to 440 V AC (0 to 440 V 3 and after) (Line voltage)
	Three-phase three-wire	(4)-(5)-(6)	0 to 440 V AC (0 to 440 V 3 and after) (Line voltage)
	Three-phase four-wire	(4)-(5)-(6)-(7)	0 to 254 V AC (0 to 254 V 3N and after) (Phase voltage)

Unit: mm in, Tolerance: ± 1.0 ± 0.04

KW4M

Screw terminal type (AKW5111/AKW5112)

11-pin type (AKW5211/AKW5212)

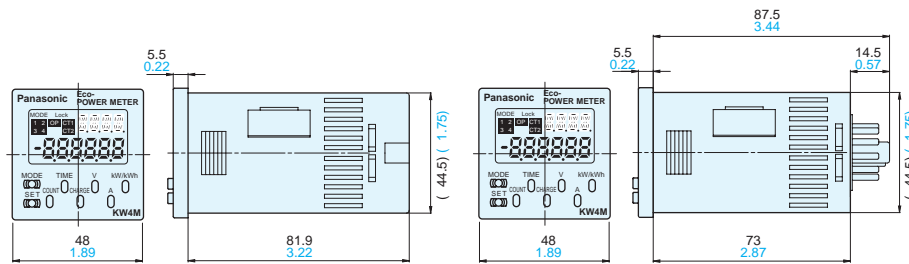

Terminal arrangement

No.	Terminal type		
	11-pin type	Screw terminal type	
1	1, R, R	RS485 (-)	M3.5 "+ / -" screw
2	2, N, S	CT1 (k)/IN	
3	3, T, T	CT1 (ℓ), CT2 (ℓ)	
4	RS485 (+)	CT2 (k)	
5	RS485 (-)	0V	
6	Pulse output (+)	Pulse output (+)	
7	Pulse output (-)	Pulse output (-)	
8	CT1 (k)/IN	1, R, R	
9	CT1 (ℓ), CT2 (ℓ)	2, N, S	
10	CT2 (k)	3, T, T	
11	0V	RS485 (+)	

Note: A DIN rail terminal socket (ATC180041) should be used for 11-pin type KW4M Eco-POWER METER.

Unit: mm in, Tolerance: ± 1.0 ± 0.04

KW7M

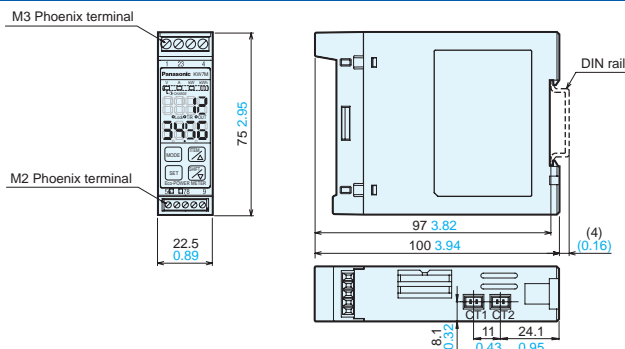

Terminal arrangement

No.	Function	Terminal type
1	1, R, R	Phoenix terminal M3 "—" screw
2	2, N, S	
3	3, T, T	
4	No connection	Phoenix terminal M2 "—" screw
5	Pulse output (+)	
6	Pulse output (-)	
7	RS485 (+)	Phoenix terminal M2 "—" screw
8	RS485 (-)	
9	RS485 (E)	

* Because the RS485(E) terminal does not have an SG (signal ground) terminal, the ground wire of the shielded cable should not be connected.

Unit: mm in, Tolerance: ± 1.0 ± 0.04

KW8M, KW8M (High performance type) and KW8M (1 A / 5 A CT input type)

AKW8115

AKW8111/AKW8111H

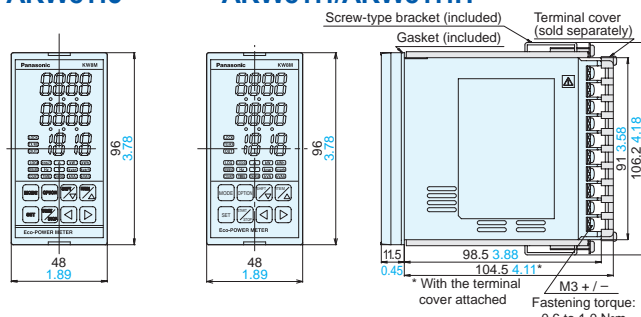

Terminal arrangement

No.	Function	No.	Function	Terminal type
1	No connection	11	P1	M3 "+ / -" screw
2	Operating power supply	12	P0	
3		13	P2	
4	Pulse input	14	P3	
5		15	CT1 (+)	
6		16	CT1 (-)	
7	Pulse output	17	CT2 (+)	
8		18	CT2 (-)	
9		19	CT3 (+)	
10		20	CT3 (-)	

* Because the RS485(E) terminal does not have an SG (signal ground) terminal, the ground wire of the shielded cable should not be connected.

CE MARKING

■ Acquisition of CE marking

When using in the application conforming to EN61010-1/IEC61010-1, make sure to satisfy the following conditions.

[Environmental conditions]

- Overvoltage category II, Pollution degree 2
- Indoor use
- An ambient temperature of -10 to 50°C **14 to 122°F**
- An ambient non-condensing humidity of 35 to 85%RH (at 20°C **68°F**)
- Altitude of 2,000 m **6,562 ft** or less

[Mount the product in a place with]

- A minimum of dust, and an absence of corrosive gases
- No flammable, explosive gasses
- Few mechanical vibrations or shocks
- No exposure to direct sunlight
- No large capacity electromagnetic switches or cables through which large current is flowing

■ Applicable standard

Safety standard	EN61010-1		
EMC	EMI EN61326-1	Radiation interference field strength Noise terminal voltage	CISPR11 class A CISPR11 class A
	EMS EN61326-1	Static discharge immunity RF electromagnetic field immunity EFT/B immunity Surge immunity Conductivity noise immunity Power frequency magnetic field immunity Voltage dip / Instantaneous stop / Voltage fluctuation immunity	EN61000-4-2 EN61000-4-3 EN61000-4-4 EN61000-4-5 EN61000-4-6 EN61000-4-8 EN61000-4-11

ENERGY EFFICIENCY SUPPORT EQUIPMENT LINEUP

Visualize Air Consumption

Air Flow Monitor EWA1



- Ultrasonic type resistant to oil mist
- No need to use dedicated filters
- Pipe size: 25A (1B) to 200A (8B)

Data collection and storage

DLL

(Data Logger Light)



- Collecting and storing power, pulse and analog data of Eco-POWER METER
- Provided with a USB port and an SD/SDHC memory card slot
- Equipped with an AC/DC power supply
- Provided with a RS232C/RS485 communication port [MEWTOCOL / MODBUS (RTU)]

Monitoring by LAN (Ethernet)

KS1 Signal Converter



- Converting RS232C/RS485 power data for communications by LAN

For cases where wired connection is difficult

KR20 Wireless Unit



- Wireless communications of RS232C/RS485 power data
- 2.4 GHz band wireless communications
- Compliant with wireless standards of Europe and Japan

Wireless Sensor EWR1

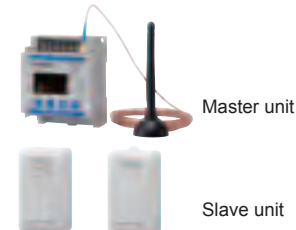

- Wireless communications of illuminance data/temperature and humidity data
- Radially connect slave units with the master unit at the center
- 2.4 GHz band wireless communications

* Please contact our sales offices for more information about which areas this product can be used.

Please contact

Panasonic Industrial Devices SUNX Co., Ltd.

2431-1 Ushiyama-cho, Kasugai-shi, Aichi, 486-0901, Japan
Global Sales Department

■Telephone: +81-568-33-7861 ■Facsimile: +81-568-33-8591
panasonic.net/id/pidsx/global