

UNISTAR V
120-230V 50/60Hz
1 to 3kVA
USER MANUAL

Staco Energy is highly specialized in the development and production of uninterruptible power systems (UPS). The UPS's of this series are high quality products, carefully designed and manufactured to ensure optimum performance.

No reproduction of any part of this manual, even partial, is permitted without the authorization of Staco Energy Products Company. The Staco Energy Products Company reserves the right to modify the product described herein, in order to improve it, at any time and without notice.

301 Gaddis Boulevard • Dayton, Ohio 45403
U.S. Toll Free 866-261-1191
(937) 253-1191 • Fax: (937) 253-1723
Web site: www.stacoenergy.com

Thank you for choosing our product.

Table of Contents

1. Important Safety Warnings	1
1.1 Transportation	1
1.2 Preparation.....	1
1.3 Installation	1
1.4 Operation	1
1.5 Maintenance, Service and Faults.....	2
1.6 WEEE.....	3
1.7 FCC (120V Models).....	3
1.8 EMC (230V Models)	3
2. Installation and setup	4
2.1 Rear panel view.....	4
2.1.1 1 kVA or 1.5kVA	4
2.1.2 2 kVA	4
3 kVA.....	5
2.3 Install the UPS.....	6
2.3.1 Rack-mount Installation	7
2.3.2 Tower Installation	7
2.4 Setup the UPS.....	8
2.5 Battery Replacement	10
2.6 Battery Kit Assembly (option).....	11
2.7 Frequency Converter Mode	13
2.8 Power Conditioner Set-Up	14
2.9 Permanently Silence Audible Alarm	15
3. Operation	16
3.1 Button operation	16
3.2 LCD Panel	17
3.3 Audible Alarm	18
3.4 LCD display wordings index	18
3.5 UPS Settings	19
3.6 Operating Mode Description	22
3.7 Faults Reference Code.....	23
3.8 Warning indicator.....	23
4. Troubleshooting.....	24
5. Storage and Maintenance	26
5.1 Operation	26
5.2 Storage.....	26
5.3 Recommended Replacement Intervals	26
6. UPS Specifications.....	27
6.1 120V Specifications	27
6.2 230V Specifications	28
6.3 Battery Pack Specification	29

1. Important Safety Warnings

Please strictly comply with all warnings and operating instructions in this manual. Save this manual and carefully read the following instructions before installing the unit. Do not operate this unit before reading through all safety information and operating instructions carefully.

1.1 Transportation

Transport the UPS system only in the original package to protect against shock and impact.

1.2 Preparation

- Condensation may occur if the UPS system is moved directly from cold to warm environment. The UPS system must be absolutely dry before being installed. Please allow at least two hours for the UPS system to acclimate to the environment.
- Do not install the UPS system near water or in moist environments.
- Do not install the UPS system where it would be exposed to direct sunlight or near a heater.
- Do not block ventilation holes in the UPS housing.

1.3 Installation

- Do not connect appliances or devices which would overload the UPS system (e.g. laser printers) to the UPS output sockets.
- Place cables in such a way that no one can step on or trip over them.
- Do not connect domestic appliances such as hair dryers to UPS output sockets.
- The UPS can be operated by individuals with no previous experience.
- The UPS can be operated in TN & TT power distribution.
- Connect the UPS system only to an earthed shockproof outlet which must be easily accessible and close to the UPS system.
- Please use only UL-tested, UL-marked power cables to connect the loads to the UPS system.
- When installing the equipment, ensure that the sum of the leakage current of the UPS and the connected devices does not exceed 3.5mA.
- Temperature Rating - Units are considered acceptable for use in a maximum ambient of 40°C (104°F).
- For PLUGGABLE EQUIPMENT, the socket-outlet shall be installed near the equipment and shall be easily accessible.
- **CAUTION:** The unit is heavy. Lifting the unit requires a minimum of two people.

1.4 Operation

- Do not disconnect the mains cable on the UPS system or the building wiring outlet (shockproof socket outlet) during operations since this would cancel the protective earth of the UPS system and of all connected loads.
- The UPS system features its own internal current source (batteries). The UPS output sockets or output terminal blocks may be electrically live even if the UPS system is not connected to the building wiring outlet.
- In order to fully disconnect the UPS system, first press the OFF/Enter button and disconnect the mains.
- Prevent fluids or other foreign objects from getting inside the UPS system.
- The EPO, RS-232 and USB circuits are IEC 60950 safety extra low voltage (SELV) circuits. This circuit must be separated from any hazardous voltage circuits by reinforced insulation.

1.5 Maintenance, Service and Faults

- The UPS system operates with hazardous voltages. Repairs may be carried out only by qualified maintenance personnel.
- **CAUTION** - Risk of electric shock. Even after the unit is disconnected from the mains (building wiring outlet), components inside the UPS system are still connected to the battery and electrically live and dangerous.
- Before carrying out any kind of service and/or maintenance, disconnect the batteries and verify that no current is present and no hazardous voltage exists in the terminals of high capability capacitors such as BUS-capacitors.
- To avoid electrical shock, turn off the unit and unplug it from the AC power source before servicing the battery.
- Only persons that are adequately familiar with batteries and with the required precautionary measures may replace batteries and supervise operations. Unauthorized persons must be kept well away from the batteries.
- **CAUTION** - Risk of electric shock. The battery circuit is not isolated from the input voltage. Hazardous voltages may occur between the battery terminals and the ground. Before touching, verify that no voltage is present!
- When changing batteries, install the same number and same type of batteries.
- Do not attempt to dispose of batteries by burning them. This could cause battery explosion.
- Do not open or destroy batteries. Escaping electrolyte can cause injury to the skin and eyes. It may be toxic.
- When replacing batteries, replace with the same type and number of batteries or battery packs.

Manufacturer	Type	Rated
Toplite (Guangzhou) Technology Battery Co Ltd (MH29104)	NPW45-12	12 V dc, 9.0 Ah
	NPW45-12 FR	12 V dc, 7.0 Ah
	NPW36-12	12 V dc, 7.2 Ah
	NPW36-12 FR	12 V dc, 7.0 Ah
CSB Battery Co Ltd (MH14533)	UPS 12360 7 FR	12 V dc, 7.1 Ah
	UPS 12460 F2FR	12 V dc, 9.0 Ah
	HR 1234W FR	12 V dc, 8.5 Ah
Yuasa Battery (Guangdong) Co Ltd (MH29616)	NPW45-12	12 V dc, 8.0 Ah
	NPW45-12FR	12 V dc, 8.0 Ah

- Do not dismantle the UPS system.
- **WARNING** - A battery can present a risk of electrical shock and high short-circuit current. The following precautions should be observed when working on batteries:
 - a) Remove watches, rings, or other metal objects.
 - b) Use tools with insulated handles.
 - c) Wear rubber gloves and boots.
 - d) Do not lay tools or metal parts on top of batteries.
 - e) Disconnect charging source prior to connecting or disconnecting battery terminals.
 - f) Determine if battery is inadvertently grounded. If inadvertently grounded, remove source from ground. Contact with any part of a grounded battery can result in electrical shock. The likelihood of such shock can be reduced if such grounds are removed during installation and maintenance.

1.6 WEEE

Information for Protection of the Equipment

UPS SERVICING – This UPS and batteries makes use of components dangerous for the environment (electronic cards, electronic components). The components removed must be taken to specialized collection and disposal centers.



Notice to European Union Customers: Disposal of Old Appliances – This product has been supplied from an environmentally aware manufacturer that complies with Waste Electrical and Electronic Equipment (WEEE) Directive 2002/96/CE. The "crossed-out wheeled bin" symbol at right is placed on this product to encourage you to recycle wherever possible. Please be environmentally responsible and recycle this product through your recycling facility at its end of life. Do not dispose of this product as unsorted municipal waste. Follow local municipal waste ordinances for proper disposal provisions to reduce the environmental impact to waste electrical and electronic equipment (WEEE).

1.7 FCC (120V Models)

NOTE: This equipment has been tested and found to comply with the limits for a Class A digital device, pursuant to part 15 of the FCC Rules. These limits are designed to provide reasonable protection against harmful interference when the equipment is operated in a commercial environment. This equipment generates, uses, and can radiate radio frequency energy and, if not installed and used in accordance with the instruction manual, may cause harmful interference to radio communications. Operation of this equipment in a residential area is likely to cause harmful interference in which case the user will be required to correct the interference at his own expense.

1.8 EMC (230V Models)

WARNING: This is a category C2 UPS product. In a residential environment, this product may cause radio interference, in which case the user may be required to take additional measures.

2. Installation and setup

NOTE: Before installation, please inspect the unit. Be sure that nothing inside the package is damaged. Please keep the original package in a safe place for future use.

NOTE: There are two different types of online UPS: standard and long-run models. Please refer to the following model table.

Model No.	Type	Model No.	Type
SCV-1000x	Standard Model	SCV-1000x-LB	Long-run Model
SCV-1500x		SCV-1500x-LB	
SCV-2000x		SCV-2000x-LB	
SCV-3000x		SCV-3000x-LB	

2.1 Rear panel view

2.1.1 1 kVA or 1.5kVA

120V version

240V version

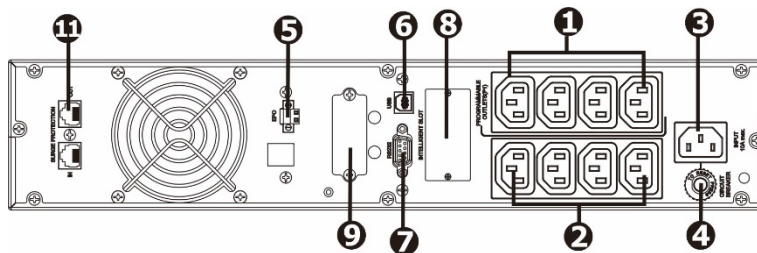

2.1.2 2 kVA

120V version

240V version

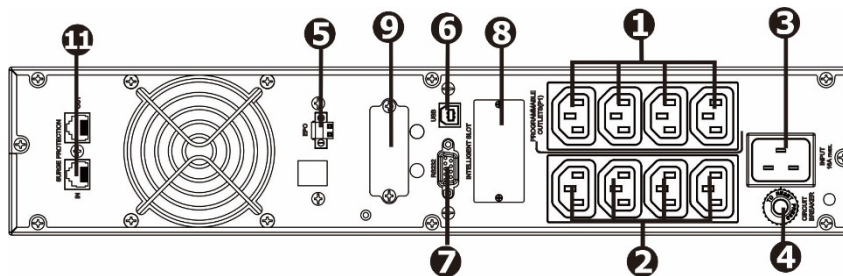

3 kVA

120V version

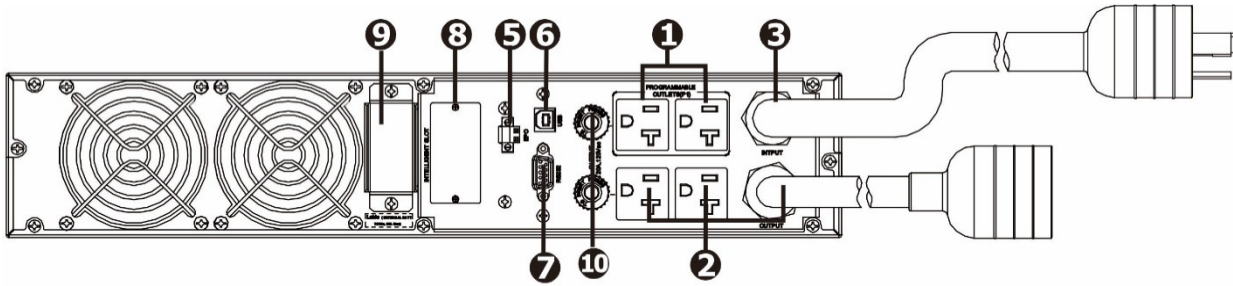

240V version

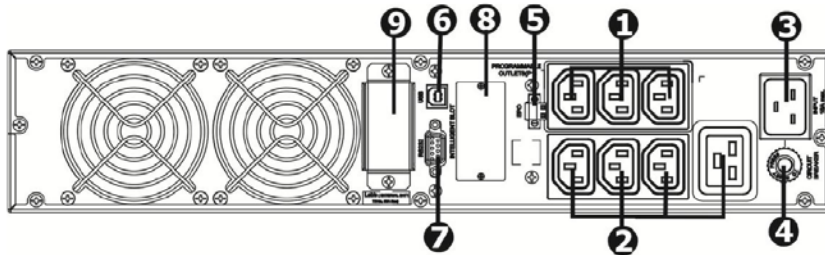

1. Programmable outlets: connect to non-critical loads.
2. Output receptacles: connect to mission-critical loads.
3. AC input
4. Input circuit breaker
5. Emergency power off function connector (EPO)
6. USB communication port
7. RS-232 communication port
8. SNMP intelligent slot
9. External battery connector
10. Output circuit breaker
11. Modem/phone/network surge protection

kVA	Volt	Input Connection	Output Connection
1kVA	120V	5-15P	5-15R
1.5kVA		5-15P	5-15R
2kVA		5-20P	5-20R
3kVA		L5-30P	5-20R & L5-30R
1kVA	230V	IEC320-C14	IEC320-C13
1.5kVA		IEC320-C14	IEC320-C13
2kVA		IEC320-C20	IEC320-C13
3kVA		IEC320-C20	IEC320-C20 & IEC320-C13

Table 1 – Input/Output Connections

2.2 Operating principle

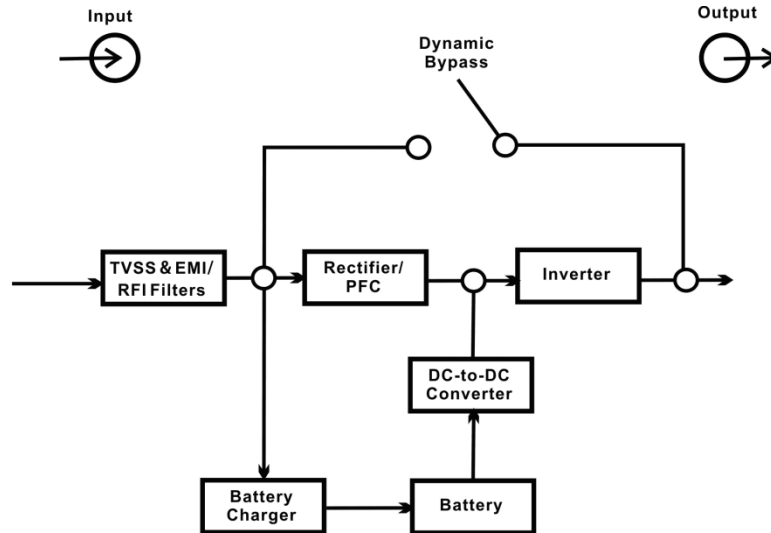

The UPS is composed of mains input, TVSS and EMI/RFI filters, rectifier/PFC, inverter, battery charger, DC-to-DC converter, battery, dynamic bypass and UPS output.

2.3 Install the UPS

For safety consideration, the UPS is shipped out from factory without connecting battery wires. Before installing the UPS, please follow the below steps to re-connect battery wire.

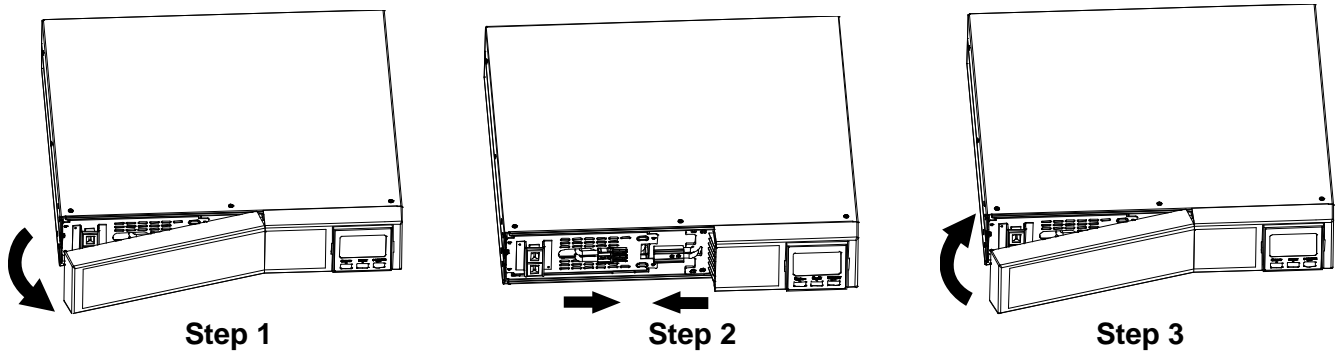

Step 1: Remove front panel.

Step 2: Remove battery panel and re-connect battery wire.

Step 3: Put battery panel and cover back to the unit.

This UPS can be either displayed on the desk or mounted in the 19" rack chassis. Please choose proper installation to position this UPS.

2.3.1 Rack-mount Installation

CAUTION – Do NOT use the mounting brackets to lift the unit. The mounting brackets are only for securing the unit to the rack.

Install UPS alone

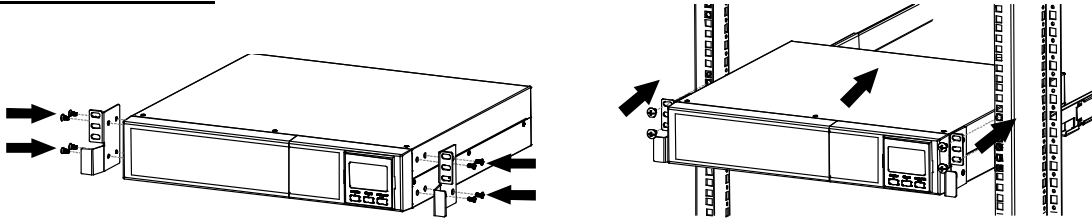

Install UPS and external battery

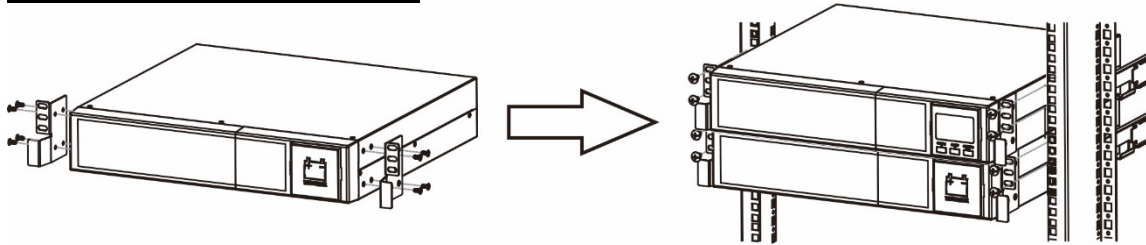

2.3.2 Tower Installation

Install UPS alone

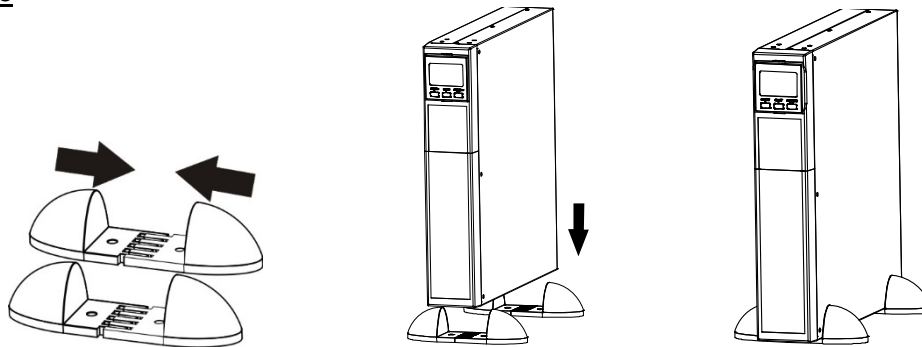

Install UPS and external battery

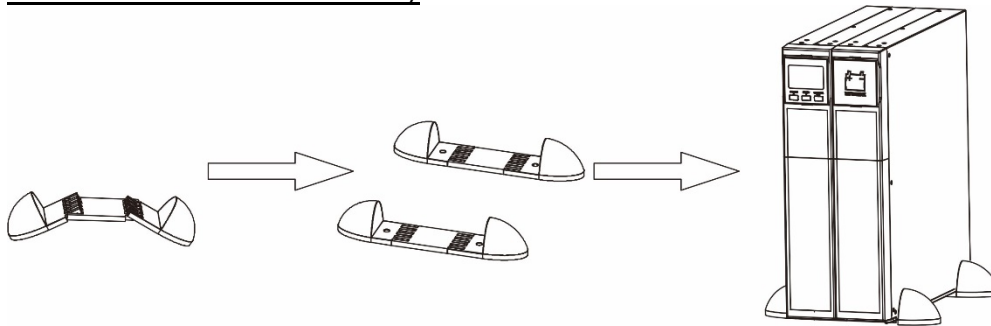

NOTE: When installing the UPS or battery pack with feet, keep 2.76in distance from the edge of the unit.

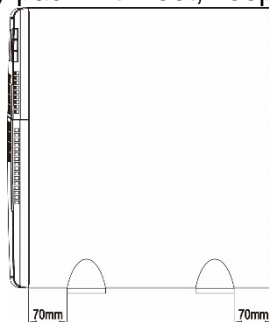

2.4 Setup the UPS

Step 1: UPS input connection

Plug the UPS into a two-pole, three-wire, grounded receptacle only. Avoid using extension cords.

CAUTION: For 1 and 2 kVA models, to reduce the risk of fire, connect only to a circuit provided with 20 amperes maximum branch circuit overcurrent protection in accordance with the National Electric Code, ANSI/NFPA 70.

CAUTION: For 3 kVA models, to reduce the risk of fire, connect only to a circuit provided with 30 amperes maximum branch circuit overcurrent protection in accordance with the National Electric Code, ANSI/NFPA 70.

Step 2: UPS output connection

There two kinds of outputs: programmable outlets and general outlets. Connect non-critical devices to the programmable outlets and critical devices to the general outlets. During power failure, you may extend the backup time to critical devices by setting shorter backup time for non-critical devices.

Step 3: Communication connection

Communication port:

USB port



RS-232 port

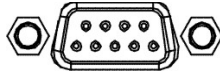

Intelligent slot



To allow for unattended UPS shutdown/start-up and status monitoring, connect one end of the communication cable to the USB/RS-232 port and the other end to the communication port of your PC. With the monitoring software installed, you can perform these operations:

- Remote Shutdown of UPS
- Send shutdown commands to remote computers
- Remotely set parameters of the UPS
- Set-up the number of battery strings connected
- Set-up voltage and frequency ranges

See manual for monitoring software for details.

The UPS is equipped with an intelligent slot perfect for either a SNMP or an AS400 card. Installing either a SNMP or AS400 card in the UPS will provide advanced communication and monitoring options.

NOTE: USB port and RS-232 port can't work at the same time.

Step 4: Network connection

Network/Fax/Phone surge port



Connect a single modem/phone/fax line into surge-protected "IN" outlet on the back panel of the UPS unit. Connect from "OUT" outlet to the equipment with another modem/fax/phone line cable.

Step 5: Disable and enable EPO function

Keep pin 1 and pin 2 closed for UPS normal operation. To activate EPO function, cut the wire between pin 1 and pin 2.

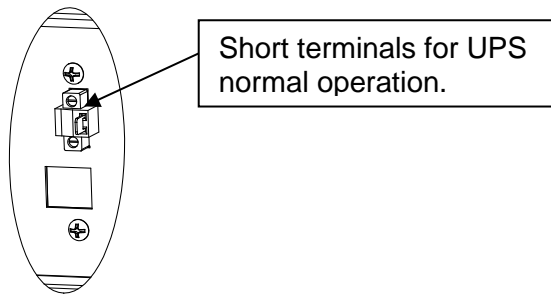

Step 6: External battery connection

Connect one end of external battery cable to UPS unit and the other end to battery pack. See below chart for detailed connection.

CAUTION: Connection to External Battery shall be installed by SERVICE PERSONNEL only.

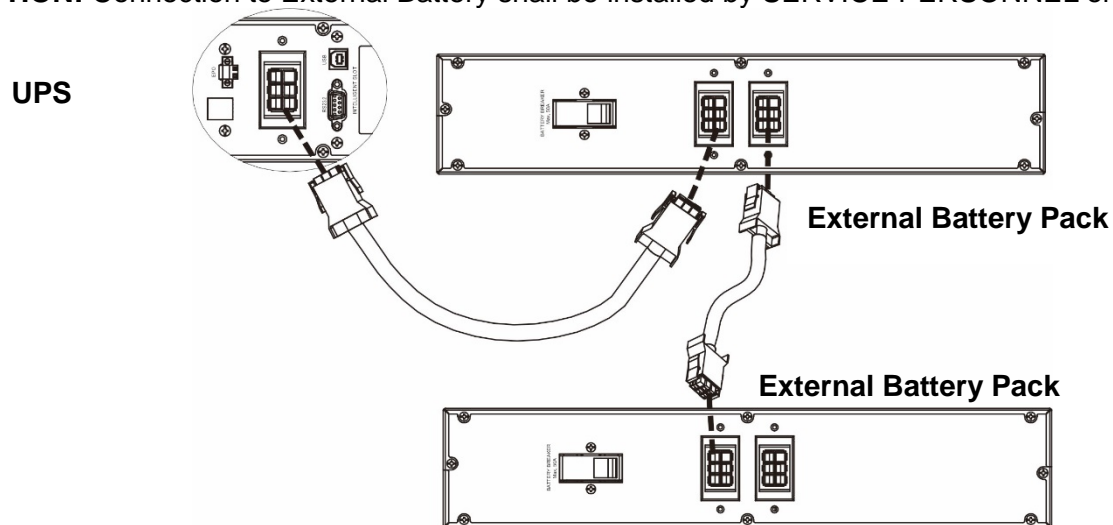

CAUTION – Risk of fire hazard.

Step 7: Turn on the UPS

Press the ON/Mute button on the front panel for two seconds to power on the UPS.

Note: The battery charges fully during the first five hours of normal operation. Do not expect full battery run capability during this initial charge period.

Step 8: Install software

Install UPS monitoring software to fully configure UPS shutdown. Follow the steps below to download and install monitoring software:

1. Go to the website <http://www.power-software-download.com>
2. Click ViewPower software icon and then choose your required OS to download the software.
3. Follow the on-screen instructions to install the software.
4. When your computer restarts, the monitoring software will appear as an orange plug icon located in the system tray, near the clock.

2.5 Battery Replacement

NOTICE: This UPS is equipped with internal batteries and only service personnel can replace the batteries.

CAUTION!! Consider all warnings, cautions, and notes before replacing batteries.

NOTE: Upon battery disconnection, equipment is not protected from power outages.

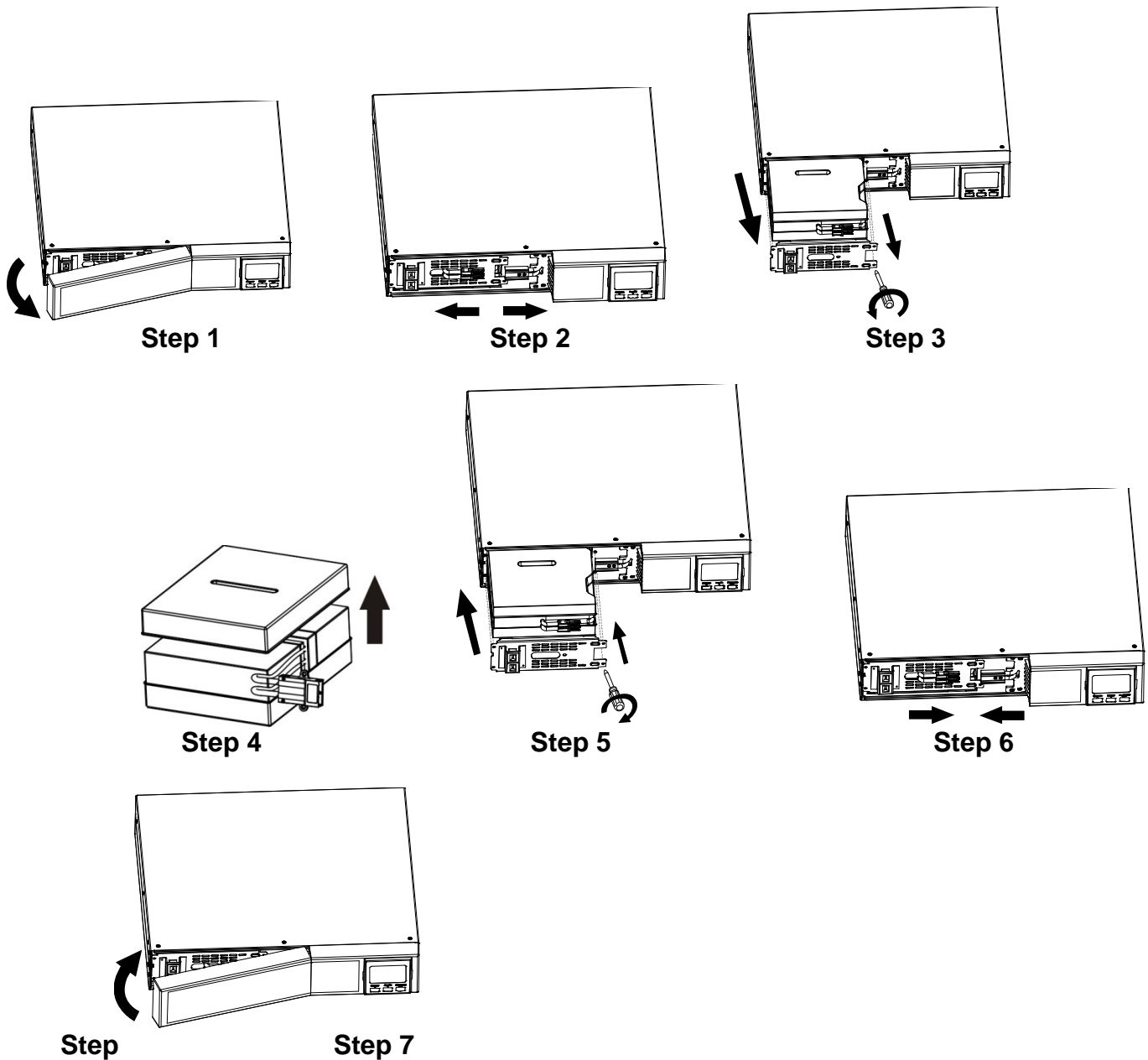

Step 1: Remove front panel.

Step 2: Disconnect battery wire and remove battery panel.

Step 3: Pull out the battery box.

Step 4: Remove the top cover of battery box and replace the inside batteries.

Step 5: After replacing the batteries, put the battery box back to original location and screw in tightly.

Step 6: Re-connect the battery wire and screw battery panel back on the unit.

Step 7: Put the front panel back on the unit.

2.6 Battery Kit Assembly (option)

NOTICE: Replacement battery pack comes fully assembled from the factory. Consult factory for details.

2-battery kit – 1kVA

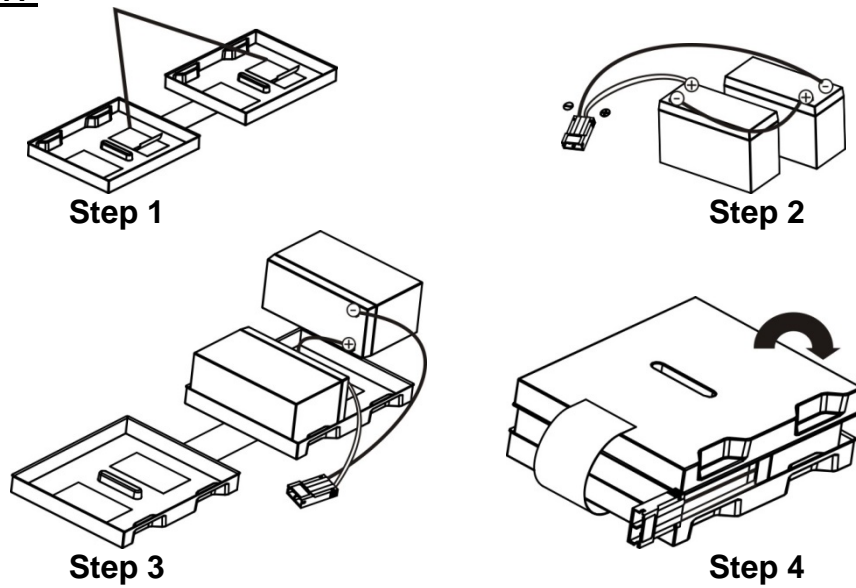

Step 1: Remove adhesive tapes.

Step 2: Connect all battery terminals by following below picture.

Step 3: Put assembled battery packs on one side of plastic shells.

Step 4: Cover the other side of plastic shell as shown below. Then, battery kit is fully assembled.

3-battery kit – 1.5kVA

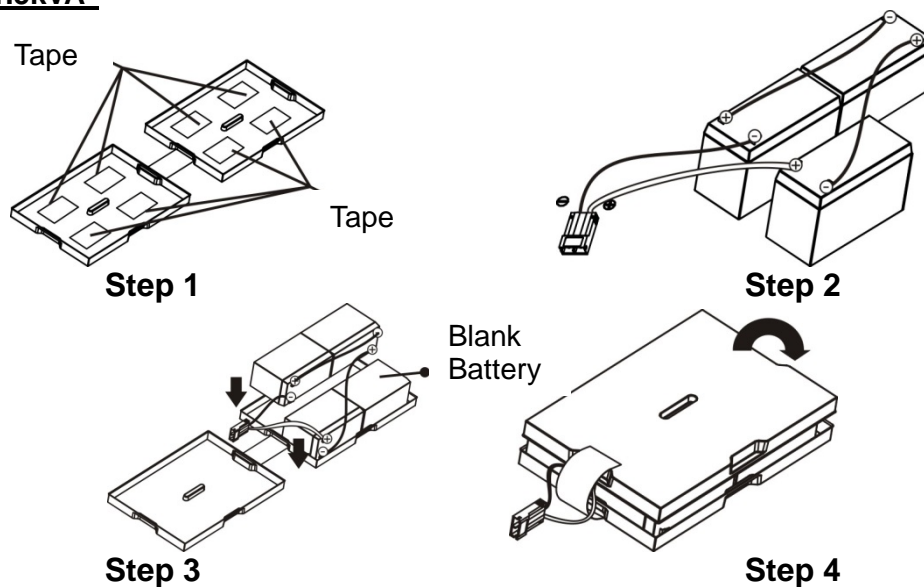

Step 1: Remove adhesive tapes.

Step 2: Connect all battery terminals by following below picture.

Step 3: Put assembled battery packs on one side of plastic shells and insert one more defect battery in the open space. (Blank battery is not connected)

Step 4: Cover the other side of plastic shell as shown below. Then, battery kit is fully assembled

4-battery kit – 2kVA

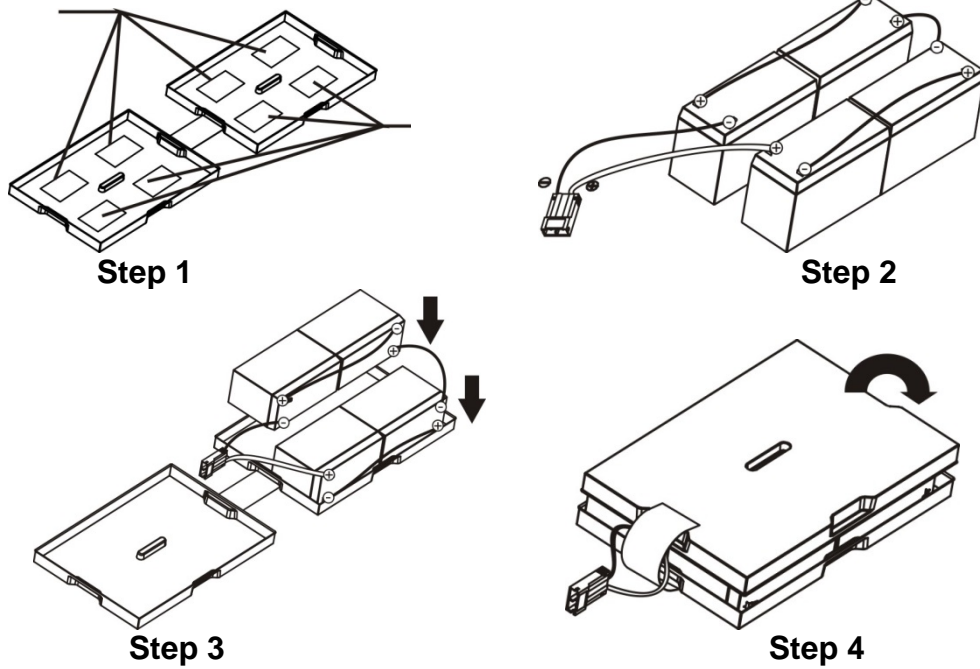

Step 1: Remove adhesive tapes.

Step 2: Connect all battery terminals by following below picture.

Step 3: Put assembled battery packs on one side of plastic shells.

Step 4: Cover the other side of plastic shell as shown below. Then, battery kit is fully assembled.

6-battery kit – 3kVA

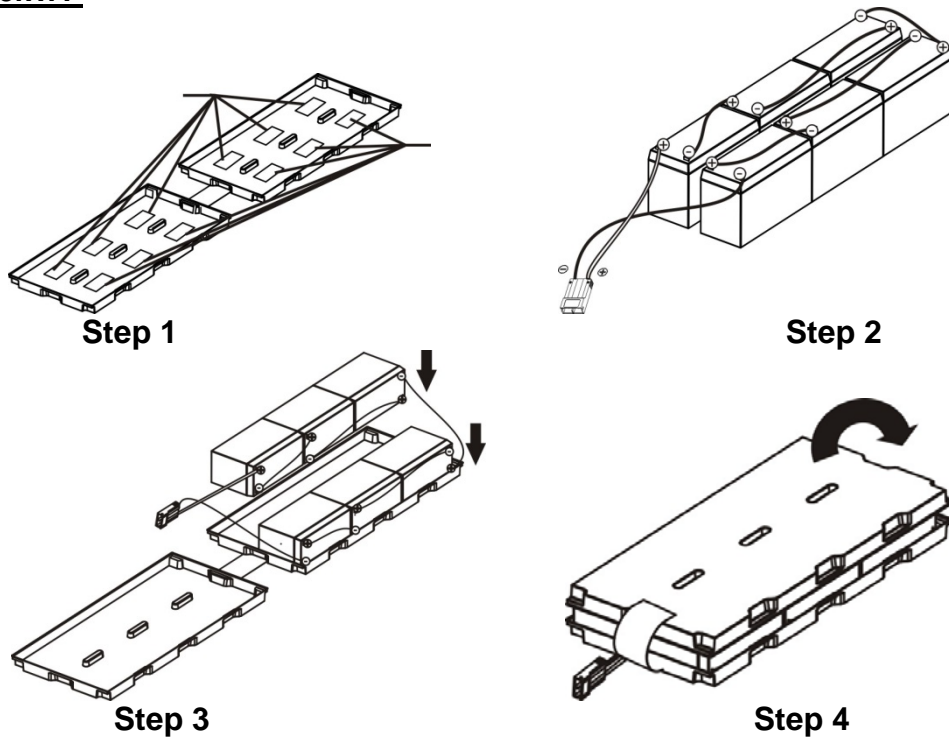

Step 1: Remove adhesive tapes.

Step 2: Connect all battery terminals by following below picture.

Step 3: Put assembled battery packs on one side of plastic shells.

Step 4: Cover the other side of plastic shell as shown below. Then, battery kit is fully assembled.

2.7 Frequency Converter Mode

To set-up the unit to run as a Frequency Converter Mode follow the instructions below.

1. Install the UPS system per the instructions above.
2. Verify mains input is connected correctly, and the UPS input breaker is at “ON” position.
3. If battery pack is installed: Verify battery is connected correctly, and the battery pack breaker is at “ON” position.
4. Apply input power.
5. Press and hold the Select Button for 5 seconds. This will enter program mode.
6. Press down Key (“SELECT”) until you get to setting #2.

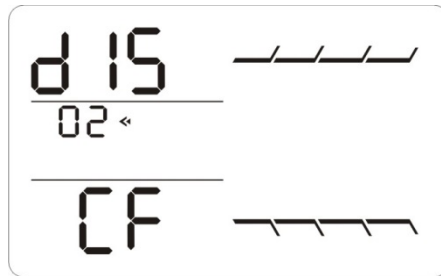

7. Press “OFF/ENTER” button to enter selection.
8. Press “ON/MUTE” button to “ENA”.
9. Press “OFF/ENTER” button to set selection.
10. Press down Key (“SELECT”) until you get to setting #3.

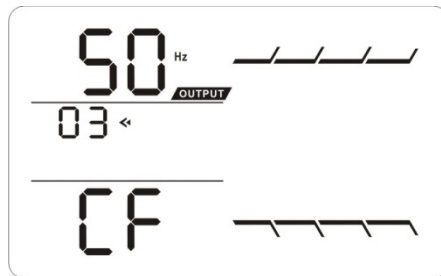

11. Press “OFF/ENTER” button to enter selection.
12. Press “ON/MUTE” button to select the desired output frequency:
 - a. CF 50: presents output frequency is 50Hz.
 - b. CF 60: presents output frequency is 60Hz.
13. Press “OFF/ENTER” button to set selection.
14. Press down Key (“SELECT”) until you get to setting #00 to exit Program mode.
15. Turn On unit per the instructions in the User’s Manual and verify the output frequency is correct.

 If Frequency Converter mode is used without batteries and the unit is turned off (manually or power outage), the unit will need to be manually restarted.

 When the unit is used without batteries connected, the unit will give a constant battery open alarm. To permanently silence this alarm, see **Section 2.9 Permanently Silence Audible Alarm**

2.8 Power Conditioner Set-Up

To set-up the unit to run as a Power Conditioner (no batteries connected) follow the instructions below.

1. Install the UPS system per the instructions above.
2. Verify mains input is connected correctly, and the UPS input breaker is at “ON” position;
3. Apply input power.
4. Press and hold the Select Button for 5 seconds. This will enter program mode.
5. Press down Key (“SELECT”) until you get to setting #6.



6. Press “OFF/ENTER” button to enter selection.
7. Press “ON/MUTE” button to “ENA”. This will enable bypass mode.
8. Press “OFF/ENTER” button to set selection.
9. Press down Key (“SELECT”) until you get to setting #00 to exit Program mode.
10. Turn On unit per the instructions in the User’s Manual and verify the output frequency is correct.



When input power is applied, the unit initialize and apply power to the output via the static bypass. When the unit is turned on, the unit will transfer to inverter mode.



When the input power is re-applied after a power outage, the unit will automatically re-start the controls and apply power to the output via the static bypass. The customer will need to manually press the “On” button to transfer to inverter mode.



When the unit is used without batteries connected, the unit will give a constant battery open alarm. To permanently silence this alarm, see **Section 2.9 Permanently Silence Audible Alarm**

2.9 Permanently Silence Audible Alarm



WARNING: This procedure will not allow the audible alarm to activate for any alarm or fault.

1. On CD that came with unit, install ViewPower software per software instructions.
2. Connect USB cord from computer to UPS unit (see Section 2.1 Rear panel view).
3. Open ViewPower software.
4. Click on connected unit.



5. Click on **Login** in upper right corner.
6. Enter password (default: administrator).
7. Click on **UPS Settings**.
8. Click on **Parameter Settings**.
9. Set parameter **UPS Alarm** to **Disable**.
10. Click **Apply**.



To turn on Audible Alarm, set **UPS Alarm** to **Enable**.

3. Operation

3.1 Button operation



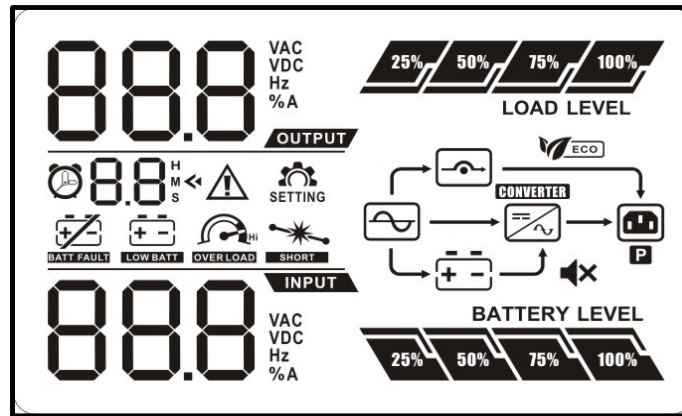

Button	Function
ON/Mute Button	<ul style="list-style-type: none"> ➤ Turn on the UPS: Press and hold ON/Mute button for at least 2 seconds to turn on the UPS. ➤ Mute the alarm: After the UPS is turned on in battery mode, press and hold this button for at least 5 seconds to disable or enable the alarm system. ➤ Up key: Press this button to display previous selection in UPS setting mode. ➤ Switch to UPS self-test mode: Press ON/Mute button for 5 seconds to enter UPS self-testing while in AC mode, ECO mode, AECO mode, or converter mode.
OFF/Enter Button	<ul style="list-style-type: none"> ➤ Turn off the UPS: Press and hold this button at least 2 seconds to turn off the UPS in battery mode. UPS will be in standby mode under power normal or transfer to bypass mode if the Bypass is enabled. ➤ Confirm selection key: Press this button to confirm selection in UPS setting mode.
Select Button	<ul style="list-style-type: none"> ➤ Switch LCD message: Press this button to change the LCD message for input voltage, input frequency, battery voltage, output voltage, output frequency. ➤ Setting mode: Press and hold this button for 5 seconds to enter UPS setting mode when in Standby and Bypass mode. ➤ Down key: Press this button to display next selection in UPS setting mode.
ON/Mute + Select Button	<ul style="list-style-type: none"> ➤ Switch to bypass mode: When the main power is normal, press ON/Mute and Select buttons simultaneously for 5 seconds. UPS will enter bypass mode. This action will be ineffective when the input voltage is out of acceptable range.

3.2 LCD Panel

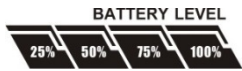

Display	Function
Remaining backup time information	
	Indicates the remaining backup time in pie chart.
	Indicates the remaining backup time in numbers. H: hours, M: minute, S: second
Fault information	
	Indicates that warning and fault occurred.
	Indicates the warning and fault codes. The codes are listed in detail in section 3-5.
Mute operation	
	Indicates that the UPS alarm is disabled.
Output & Battery voltage information	
	Indicates the output voltage, frequency or battery voltage. Vac: output voltage, Vdc: battery voltage, Hz: frequency
Load information	
	Indicates the load level by 0-25%, 26-50%, 51-75%, and 76-100%.
	Indicates overload.
	Indicates the load or the UPS output is short circuit.
Mode operation information	
	Indicates the UPS is connected to the mains.
	Indicates the battery is working.
	Indicates the bypass circuit is working.
	Indicates the ECO mode is enabled.
	Indicates the Inverter circuit is working.
	Indicates the output is working.
Programmable outlets information	
	Indicates that programmable outlets have output voltage.

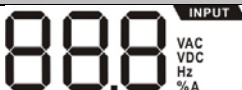
Battery information	
	Indicates the Battery level by 0-25%, 26-50%, 51-75%, and 76-100%.
	Indicates the battery is at fault.
	Indicates low battery level and low battery voltage.
Input & Battery voltage information	
	Indicates the input voltage or frequency or battery voltage. Vac: Input voltage, Vdc: battery voltage, Hz: input frequency

3.3 Audible Alarm

Battery Mode	Sounding every 4 seconds
Low Battery	Sounding every second
Overload	Sounding twice every second
Fault	Continuously sounding

3.4 LCD display wordings index

Abbreviation	Display content	Meaning
ENA	ENA	Enable
DIS	DIS	Disable
ESC	ESC	Escape
HLS	HLS	High loss
LLS	LLS	Low loss
BAT	BAT	Battery
CF	CF	Converter
TP	TP	Temperature
CH	CH	Charger
SF	SF	Site Fault
EP	EP	EPO
FU	FU	Bypass frequency unstable
EE	EE	EEPROM error

3.5 UPS Settings

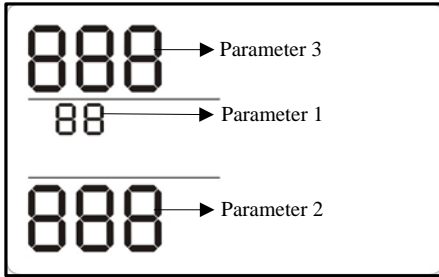

There are three parameters to set up the UPS.

Parameter 1: Program alternatives. Refer to below table.

Parameter 2 and Parameter 3 are the setting options or values for each program.

01: Output voltage setting

Interface	Setting
	<p>For 200/208/220/230/240 VAC models, you may choose the following output voltage:</p> <ul style="list-style-type: none"> 200: presents output voltage is 200Vac 208: presents output voltage is 208Vac 220: presents output voltage is 220Vac 230: presents output voltage is 230Vac 240: presents output voltage is 240Vac <p>For 100/110/115/120VAC models, you may choose the following output voltage:</p> <ul style="list-style-type: none"> 100: presents output voltage is 100Vac 110: presents output voltage is 110Vac 115: presents output voltage is 115Vac 120: presents output voltage is 120Vac

02: Frequency Converter enable/disable

Interface	Setting
	<p>CF ENA: converter mode enable CF DIS: converter mode disable(Default)</p>

03: Output frequency setting

Interface	Setting
	<p>You may set the initial frequency on battery mode:</p> <ul style="list-style-type: none"> BAT 50: presents output frequency is 50Hz BAT 60: presents output frequency is 60Hz <p>If converter mode enable, you may choose the following output frequency:</p> <ul style="list-style-type: none"> CF 50: presents output frequency is 50Hz CF 60: presents output frequency is 60Hz

04: ECO enable/disable

Interface	Setting
	<p>ENA: ECO mode enable DIS: ECO mode disable(Default)</p>

05: AECO enable/disable

Interface	Setting
	<p>ENA: Advanced ECO mode enable DIS: Advanced ECO mode disable(Default)</p>

06: Bypass mode enable/disable when UPS is off

Interface	Setting
	<p>ENA: Bypass mode is enabled when UPS is off DIS: Bypass mode is disabled when UPS is off (Default)</p>

07: Programmable outlets enable/disable

Interface	Setting
	<p>ENA: Programmable outlets enable DIS: Programmable outlets disable(Default)</p>

08: Programmable outlets setting

Interface	Setting
	<p>0-999: setting the backup time limits in minutes from 0-999 for programmable outlets which connect to non-critical devices on battery mode.</p>

09: Acceptable input voltage range setting

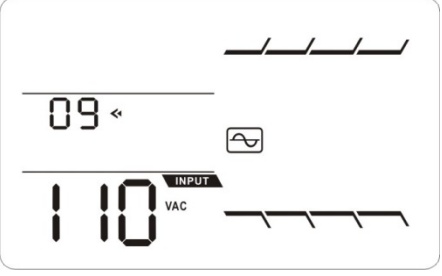
Interface	Setting
	<p>For 200/208/220/230/240 VAC models, you may choose the following selection for acceptable input voltage range:</p> <ul style="list-style-type: none"> 110/300 flashing in turns: The acceptable input voltage range is from 110V to 300V. 160/260 flashing in turns: The acceptable input voltage range is from 160V to 260V. 170/270 flashing in turns: The acceptable input voltage range is from 170V to 270V. <p>For 100/110/115/120 VAC models, you may choose the following selection for acceptable input voltage range:</p> <ul style="list-style-type: none"> 55/150 flashing in turns: The acceptable input voltage range is from 55V to 150V. 80/130 flashing in turns: The acceptable input voltage range is from 80V to 130V. 85/135 flashing in turns: The acceptable input voltage range is from 85V to 135V.

00: Exit setting

3.6 Operating Mode Description

Operating mode	Description	LCD display
Online mode	When the input voltage is within acceptable range, UPS will provide pure and stable AC power to output. The UPS will also charge the battery in online mode.	
ECO mode (Efficiency Corrective Optimizer)	When the input voltage is within setting range ($\pm 3\%V_o$ max), UPS will bypass voltage to output for energy saving. PFC and INVERTER are still active in this mode.	
AECO mode (Advanced Efficiency Corrective Optimizer)	When the input voltage is within setting range ($\pm 3\%V_o$ max), UPS will bypass voltage to output for energy saving. PFC and INVERTER are off in this mode.	
Frequency Converter mode	When input frequency is within 40 Hz to 70 Hz, the UPS can be set at a constant output frequency, 50 Hz or 60 Hz. The UPS will still charge battery under this mode.	
Battery mode	When the input voltage is beyond the acceptable range or power failure occurs and alarm is sounding every 4 seconds, UPS will backup power from battery.	
Bypass mode	When input voltage is within acceptable range but UPS is in overload, UPS will enter bypass mode or bypass mode can be set by front panel. Alarm sounds every 10 seconds.	

Standby mode	UPS is powered off and without output power, but the battery still can be charged.	
Fault mode	The UPS is in fault mode when no output power is supplied from the UPS and the fault icon flashes on the LCD display, although the UPS information can be displayed on the screen.	

3.7 Faults Reference Code











Fault event	Fault code	Icon	Fault event	Fault code	Icon
Bus start fail	01	x	Inverter voltage Low	13	X
Bus over	02	x	Inverter output short	14	
Bus under	03	x	Battery voltage too high	27	
Bus unbalance	04	x	Battery voltage too low	28	
Bus short circuited	05	x	Over temperature	41	X
Inverter soft start fail	11	x	Over load	43	
Inverter voltage high	12	x			

3.8 Warning indicator

Warning	Icon (flashing)	Alarm
Low Battery		Sounding every second
Overload		Sounding twice every second
Battery is not connected		Sounding every second
Over Charge		Sounding every second
Site Fault	SF	Sounding every second
EPO enable	EP	Sounding every second
Over temperature	EP	Sounding every second
Charger failure	CH	Sounding every second
Battery fault		Sounding every second
Out of bypass voltage range		Sounding every second
Bypass frequency unstable	FU	Sounding every second
EEPROM error	EE	Sounding every second

4. Troubleshooting

If the UPS system does not operate correctly, use the table below to check problem.

Symptom	Possible cause	Remedy
No indication and alarm even though the main is normal.	The AC input power is not connected properly.	Check if input power cord firmly connected to the mains.
	The AC input is connected to the UPS output.	Plug AC input power cord to AC input correctly.
The icon  is flashing and the warning code EP is lighting on LCD display. Alarm is sounding every second.	EPO function is activated.	Set the circuit in closed position to disable EPO function.
The icon  is flashing and SF is lighting on LCD display. Alarm is sounding every second.	Line and neutral conductors of UPS input are reversed.	Rotate mains power socket by 180° and then connect to UPS system.
The icon  and  flashing on LCD display and alarm is sounding every second.	The external or internal battery is incorrectly connected.	Check if all batteries are connected properly.
Fault code is shown as 27 and the icon  is lighting on LCD display and alarm is continuously sounding.	Battery voltage is too high or the charger is at fault.	Contact the manufacturer.
Fault code is shown as 28 and the icon  is lighting on LCD display and alarm is continuously sounding.	Battery voltage is too low or the charger is fault.	Contact the manufacturer.
The icon  and  is flashing on LCD display and alarm is sounding twice every second.	UPS is overloaded	Remove excess loads from UPS output.
	UPS is overloaded. Devices connected to the UPS are fed directly by the electrical network via the Bypass.	Remove excess loads from UPS output.
	After repetitive overloads, the UPS is locked in the Bypass mode. Connected devices are fed directly by the mains.	Remove excess loads from UPS output first. Then shut down the UPS and restart it.
Fault code is shown as 43 and The icon  is lighting on LCD display and alarm is continuously sounding.	The UPS shut down automatically because of overload at the UPS output.	Remove excess loads from UPS output and restart it.
Fault code is shown as 14 and the icon  is lighting on LCD display. Alarm is continuously sounding.	The UPS shut down automatically because short circuit occurs on the UPS output.	Check output wiring and if connected devices are in short circuit status.
Fault code is shown as 01, 02, 03, 04, 11, 12, 13 and 41 on LCD display and alarm is continuously sounding.	A UPS internal fault has occurred. There are two possible results: 1. The load is still supplied, but directly from AC power via bypass. 2. The load is no longer supplied by power.	Contact the manufacturer

Symptom	Possible cause	Remedy
Battery backup time is shorter than nominal value	Batteries are not fully charged	Charge the batteries for at least 5 hours and then check capacity. If the problem still persists, consult the manufacturer.
	Batteries defective	Contact the manufacturer to replace the batteries.
Fault code is shown as 05 on LCD display. At the same time, alarm is continuously sounding and output is cut off.	A UPS internal fault has occurred and BUS is short circuited.	Consult the manufacturer. If the UPS power is on again before repair, the DC/DC mosfet will be damaged.

5. Storage and Maintenance

5.1 Operation

The UPS system contains no user-serviceable parts. If the battery service life (3-5 years at 25°C ambient temperature) has been exceeded, the batteries must be replaced. In this case, please contact the manufacturer for replacement battery packs.



Be sure to deliver the spent battery to a recycling facility.

5.2 Storage

Before storing, charge the UPS for 5 hours. Store the UPS covered and upright in a cool, dry location.

During storage, recharge the battery in accordance with the following table:

Storage Temperature	Recharge Frequency	Charging Duration
-25°C - 30°C (-13°F - 86°F)	Every 8 months	5-8 hours
30°C - 40°C (86°F - 104°F)	Every 90 days	5-8 hours
40°C - 45°C (104°F - 113°F)	Every 30 days	5-8 hours

5.3 Recommended Replacement Intervals

The Staco UPS has a long design life. Due to the characteristics of the part, not the design of the UPS, certain components used in the design have a limited life, even with proper maintenance.



Service and maintenance work must be performed only by factory authorized personnel.

Staco recommends these limited-life components be periodically inspected and replaced before the expected expiration of their life cycle. The recommended replacement schedule is an estimate only. The life of these parts depends on site conditions such as ambient temperature, load profile, cleanliness of environment and other factors.

Staco Recommends a Factory Authorized Preventative Maintenance review is schedule at least once a year.

Component	Recommend Replace in:
Fans	4-5 years
Batteries	4-5 years

The functional lifetime of VRLA batteries is significantly affected by the temperature at which they are stored and operated. Ideally, VRLA batteries should be used in a 25° C (77° F) environment. For every 8.3° C (15° F) increase in temperature, the life expectancy of a battery will be halved. Exposure to temperatures in excess of 32° C (90° F) should be limited to no more than 30 days per year. Under no circumstances should the VRLA battery be exposed to temperatures over 40° C (104° F) which can lead to thermal runaway, a condition that damages the battery. Thermal runaway can cause batteries to swell. If the battery cases burst, the hazardous contents may be exposed.

Maintaining proper ambient temperature usually requires installing the product in a temperature controlled space. Equipment rooms without cooling systems do not generally maintain the proper conditions for good battery life.

See Staco's website for warranty details:

<http://www.stacoenergy.com/support/literature-download-center.html>

6. UPS Specifications

6.1 120V Specifications

MODEL (SCV)		10001	10001-LB	15001	15001-LB	20001	20001-LB	30001	30001-LB
Capacity	VA	1000 VA	900 VA	1500VA	1250VA	2000 VA	1700 VA	3000 VA	2500 VA
	W	900 W	810 W	1350W	1125W	1800 W	1530 W	2700 W	2250 W
INPUT									
Voltage Range	Rated voltage	100VAC-120VAC							
	Low Line Transfer	80 VAC/70 VAC/60 VAC/55 VAC \pm 5 % (based on load percentage 100%-80% / 80%-70% / 70%-60% / 60%-0)							
	Low Line Comeback	85 VAC/75 VAC/65 VAC/60 VAC \pm 5 %							
	High Line Transfer	150 VAC \pm 5 %							
	High Line Comeback	142 VAC \pm 5 %							
Frequency Range		50Hz/ 60Hz							
Power Factor		\geq 0.99 @normal voltage							
OUTPUT									
Output Voltage		100*/110*/115*/120VAC							
AC Voltage Regulation		\pm 1%							
Frequency Range		47 ~ 53 Hz or 57 ~ 63 Hz (Synchronized Range)							
Frequency Range		50Hz \pm 0.5% or 60Hz \pm 0.5% (Bat. Mode)							
Current Crest Ratio (CF)		5:1 (max.)							
Harmonic Distortion (THDU)		\leq 2% (Linear load) 8% max (Batt. mode before shut down)							
Transfer Time	AC to DC	Zero							
	Inverter to Bypass	4 ms (Typical)							
Waveform (Batt. Mode)		Pure Sine wave							
EFFICIENCY									
AC Mode		86% (typical), 88% (peak)				88% (typical), 90% (peak)			
Battery Mode		83% (typical), 86% (peak)				85% (typical), 88% (peak)			
BATTERY									
Battery Type	12V/9Ah	Depending on application	12V/9Ah	Depending on application	12V/9Ah	Depending on application	12V/9Ah	Depending on application	12V/9Ah
Numbers	2		3		4		6		
Typical Recharge Time		4 hours recover to 90% capacity (for standard model only)							
Charging Current (max.)		1 A	6A or 4A	1 A	6A or 4A	1 A	6A or 4A	1 A	6A or 4A
Charging Voltage		27.4 VDC \pm 1%		41.1 VDC \pm 1%		54.7 VDC \pm 1%		82.1VDC \pm 1%	
INDICATORS									
LCD		UPS status, Load level, Battery level, Input/Output/battery info, Discharge time and Fault indicators							
ALARM									
Battery Mode		Sounding every 4 seconds							
Low Battery		Sounding every second							
Overload		Sounding twice every second							
Fault		Continuously sounding							
PHYSICAL									
Dimension, DxWxH (in)		16.44 x 17.24 x 3.39		20.38 x 17.24 x 3.39		20.38 x 17.24 x 3.39		27.74 x 17.24 x 3.39	
Net Weight (lbs)		29	20	42	26	47	28	65	33
ENVIRONMENT									
Humidity		20-90 % RH @ 0- 40°C (non-condensing) (32°F - 104°F)							
Noise Level		Less than 50dBA @ 1 Meter							
MANAGEMENT									
Smart RS-232/USB		Supports Windows 2000/2003/XP/Vista/2008/7, Linux, Unix, and MAC							
Optional SNMP		Power management from SNMP manager and web browser							

*Derate capacity to 95% when the output voltage is adjusted to 115VAC. Derate capacity to 90% when the output voltage is adjusted to 110VAC. Derate capacity to 80% when the output voltage is adjusted to 100VAC.

6.2 230V Specifications

MODEL (SCV)		10002	10002-LB	15002	15002-LB	20002	20002-LB	30002	30002-LB
Capacity	VA	1000 VA		1500VA		2000 VA		3000 VA	
	W	900 W		1350W		1800 W		2700 W	
INPUT									
Voltage Range	Rated voltage	220-240 VAC							
	Low Line Transfer	160 VAC/140 VAC/120 VAC/110 VAC \pm 5 % (based on load percentage 100%-80% / 80%-70% / 70%-60% / 60%-0)							
	Low Line Comeback	170 VAC / 150 VAC / 130 VAC / 120 VAC \pm 5 %							
	High Line Transfer	300 VAC \pm 5 %							
	High Line Comeback	290 VAC \pm 5 %							
Frequency Range		40Hz ~ 70Hz							
Power Factor		\geq 0.99 @normal voltage							
OUTPUT									
Output Voltage		200/208/220/230/240 VAC							
AC Voltage Regulation		\pm 1%							
Frequency Range		47 ~ 53 Hz or 57 ~ 63 Hz (Synchronized Range)							
Frequency Range		50Hz \pm 0.5% or 60Hz \pm 0.5% (Bat. Mode)							
Current Crest Ratio (CF)		5:1 (max.)							
Harmonic Distortion (THDU)		\leq 2% (Linear load) 6% max (Batt. mode before shut down)							
Transfer Time	AC to DC	Zero							
	Inverter to Bypass	4 ms (Typical)							
Waveform (Batt. Mode)		Pure Sine wave							
EFFICIENCY									
AC Mode		87%		87%		88%		88%	
Battery Mode		85%		85%		86%		85%	
ECO Mode		94%		94%		95%		97%	
BATTERY									
Battery Type	12V/9Ah	Depending on application	12V/9Ah	Depending on application	12V/9Ah	Depending on application	12V/9Ah	Depending on application	12V/9Ah
Numbers	2		3		4		6		
Typical Recharge Time		4 hours recover to 90% capacity (for standard model only)							
Charging Current (max.)	1 A	1A/2A/ 4A/8A	1 A	1A/2A/ 4A/8A	1 A	1A/2A/ 4A/8A	1 A	1A/2A/ 4A/8A	1 A
Charging Voltage	27.4 VDC \pm 1%		41.1 VDC \pm 1%		54.7 VDC \pm 1%		82.1VDC \pm 1%		
INDICATORS									
LCD	UPS status, Load level, Battery level, Input/Output/battery info, Discharge time and Fault indicators								
ALARM									
Battery Mode	Sounding every 4 seconds								
Low Battery	Sounding every second								
Overload	Sounding twice every second								
Fault	Continuously sounding								
PHYSICAL									
Dimension, DxWxH (in)	16.44 x 17.24 x 3.39		20.38 x 17.24 x 3.39		20.38 x 17.24 x 3.39		25.10 x 17.24 x 3.39		
Net Weight (lbs)	28	19	39	24	45	24	65	30	
ENVIRONMENT									
Humidity	20-90 % RH @ 0- 40°C (non-condensing) (32°F - 104°F)								
Noise Level	Less than 50dBA @ 1 Meter								
MANAGEMENT									
Smart RS-232/USB	Supports Windows 2000/2003/XP/Vista/2008/7, Linux, Unix, and MAC								
Optional SNMP	Power management from SNMP manager and web browser								

* Derate capacity to 80% when the output voltage is adjusted to 200VAC/208VAC.

6.3 Battery Pack Specification

Model	SCV-BAT-1K	SCV-BAT-1.5K	SCV-BAT-2K	SCV-BAT-3K
Used with UPS Models	1K	1.5K	2K	3K
Battery Type	12V 9Ah	12V 9Ah	12V 9Ah	12V 9Ah
Battery Numbers	4	6	8	12
Dimensions (D"xW"xH")	15.78 x 17.24 x 3.39	15.78 x 17.24 x 3.39	19.72 x 17.24 x 3.39	24.44 x 17.24 x 3.39
Net Weight(lbs)	38	47	64	91

NOTE: Battery cabinet should be used with corresponded UPS.

Notes: