

**20mΩ P-Channel SmartSwitch for UMPC Battery Charging Applications**

**General Description**

The AAT4681 SmartSwitch enables separate stand-alone AC adapter and PMU USB chargers to independently control a single low  $R_{DS(ON)}$  power MOSFET between battery and system power output. A 20V version is available for multi-cell Li-ion applications and a 6V version is available for single-cell Li-ion applications.

The two P-channel power MOSFETs required in UMPC applications for controlling independent charger ICs can be consolidated to a single device, saving space and reducing cost. The single 20mΩ P-channel device in the AAT4681/-1 has four times lower  $R_{DS(ON)}$  than the equivalent path resistance formed by two series devices.

Ordering options are available for multi-cell and single-cell Li-ion versions. For the single-cell application, a 6V device with dual independent gate control is available. For 2-cell and 3-cell applications a 20V ordinary P-channel device is available in the same package and pin configuration. Both devices are available in the TDFN-10L 3mm x 3mm package.

**Features**

- Multi-Cell 20V Device and Single-Cell 6V Device
- Dual Independent Gate Controls
  - Independent Linear Regulator and SMPS Power Switch States are Maintained
- 3mm x 3mm TDFN-10L package
- Temperature Range: -40°C to 85°C

**Applications**

- Smart Phones
- Sub Notebooks
  - Smartbooks
  - Netbooks
- Ultra-Mobile PCs
- Wireless Media Devices

**Typical Application**

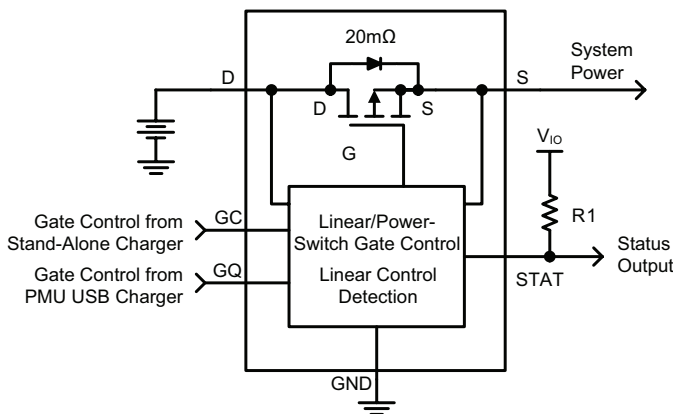

**AAT4681, AAT4681-1**

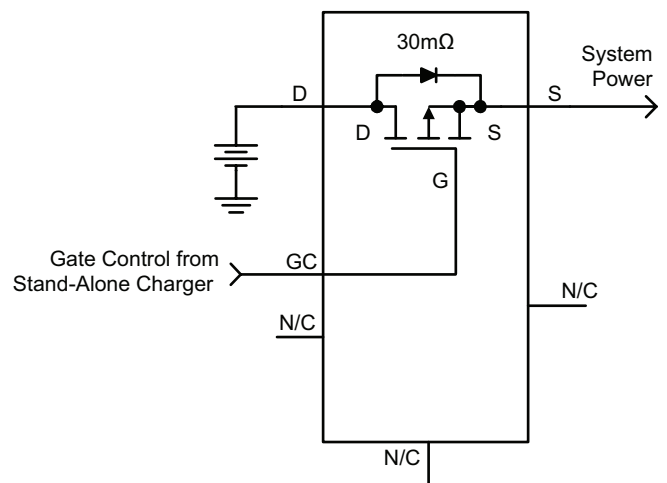

**AAT4681-2**

# AAT4681

## 20mΩ P-Channel SmartSwitch for UMPC Battery Charging Applications

### Pin Descriptions

Pin #	Pin Name		Function
	AAT4681/-1	AAT4681-2	
1, 2, 3	S	S	Source connection.
4	GQ	N/C	Gate control from PMU charger.
5	GC	GC	Gate control from stand-alone charger.
6	STAT	N/C	Open drain status output. "STAT" signal "high" means QC is "on" and "STAT" signal low means GQ is "on"
7	GND	N/C	Ground connection
8, 9, 10	D	D	Drain connection.

### Pin Configuration

#### TDFN33-10L (Top View)

AAT4681/-1

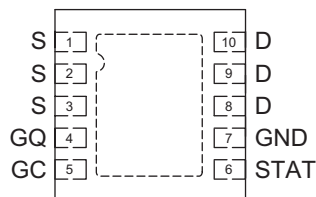

AAT4681-2

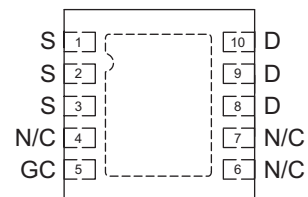

**20mΩ P-Channel SmartSwitch for UMPC Battery Charging Applications****Absolute Maximum Ratings<sup>1</sup>**

Symbol	Description	Value	Units	
<b>AAT4681, AAT4681-1</b>				
$V_D, V_S$	Drain or Source Voltage to GND	6.0	V	
$V_{STAT}$	STAT to GND	-0.3 to 6.0	V	
$I_{STAT}$	STAT Current	10	mA	
$V_{GC}, V_{GQ}$	Gate Voltage Levels to GND	-0.3 to 6.0	V	
$I_D$	Continuous Drain Current @ $T_A = 85^\circ\text{C}$	AAT4681	$\pm 7$	A
		AAT4681-1	$\pm 5$	
$I_{DM}$	Pulsed Drain Current <sup>2</sup>	$\pm 10$	A	
$I_S$	Continuous Source Current (Source-Drain Diode)	-1.5	A	
<b>AAT4681-2</b>				
$V_{DS}$	Drain-Source Voltage	-20	V	
$V_{GS}$	Gate-Source Voltage	$\pm 12$	V	
$I_D$	Continuous Drain Current	$T_A = 25^\circ\text{C}$	$\pm 4.0$	A
		$T_A = 70^\circ\text{C}$	$\pm 3.2$	A
$I_{DM}$	Pulsed Drain Current	$\pm 24$	A	
$I_S$	Continuous Source Current (Source-Drain Diode)	-1.5	A	

**Thermal Characteristics<sup>3</sup>**

Symbol	Description	Value	Units
$T_J$	Operating Junction Temperature Range	-40 to +125	$^\circ\text{C}$
$T_{LEAD}$	Maximum Soldering Temperature (at leads, 10 sec.)	300	$^\circ\text{C}$
<b>TDFN33-10L Thermal Impedance</b>			
$\theta_{JA}$	Maximum Junction-to-Ambient Thermal Resistance	50	$^\circ\text{C}/\text{W}$
$P_D$	Maximum Power Dissipation <sup>4</sup>	2	W

1 Absolute Maximum Ratings are those values beyond which the life of a device may be impaired.

2. Pulse width <300μs, duty cycle <1%.

3.  $T_J$  is calculated from the ambient temperature  $T_A$  and power dissipation  $P_D$  according to the following formula:  $T_J = T_A + P_D \cdot \theta_{JA}$ .

4. Thermal Resistance is specified with approximately 1 square inch of 1 oz. copper.

**20mΩ P-Channel SmartSwitch for UMPC Battery Charging Applications****Electrical Characteristics**

$T_A = -40^{\circ}\text{C}$  to  $+85^{\circ}\text{C}$ , unless otherwise noted. Typical values are at  $T_A = +25^{\circ}\text{C}$ .

Symbol	Description	Conditions	Min	Typ	Max	Units
<b>AAT4681/-1</b>						
$V_{SYS}$	Input Voltage Range <sup>1</sup>		1.8		5.5	V
$V_{UVLO}$	Under-Voltage Lockout	For $V_{SYS} < V_{UVLO}$ , GC active		1.4		V
$I_Q$	Quiescent Current	$V_D = 4.2\text{V}$ , $T_J = 55^{\circ}\text{C}$		3.6	15	$\mu\text{A}$
$I_{DSS}$	Drain-Source Leakage Current	$V_{GS} = 0\text{V}$ , $V_{DS} = -5.5\text{V}$ , $T_J = 55^{\circ}\text{C}$			-5	$\mu\text{A}$
$R_{DS(on)}$	P-Channel On Resistance <sup>2</sup>	$V_D = V_{GC} = 4.2\text{V}$ , $V_{GQ} = \text{GND}$ , $I_D = 5\text{A}$ , $T_A = 25^{\circ}\text{C}$		18	25	mΩ
				AAT4681	23	
$V_{HYS}$	GQ-GC Transition Hysteresis				300	mV
$t_{GSW}$	GQ-GC Transition Delay	Slew rate of QG @ 1ms		10		$\mu\text{s}$
$V_{STATLOW}$	STAT Logic Output Low	$I_{STAT(SINK)} = 1\text{mA}$		0.025	0.4	V
$I_{STAT(SINK)}$	STAT Logic High Leakage Current	$V_{STAT} = 5.5\text{V}$ , $V_{GC} = 5.5\text{V}$ , $V_{GQ} = \text{GND}$		0.005	1	$\mu\text{A}$
<b>AAT4681-2</b>						
$BV_{DSS}$	Drain-Source Breakdown Voltage	$V_{GS} = 0\text{V}$ , $I_D = -250\mu\text{A}$	-20			V
$R_{DS(ON)}$	Drain-Source On-Resistance <sup>2</sup>	$V_{GS} = -4.5\text{V}$ , $I_D = -4.0\text{A}$		27	40	mΩ
$I_{D(ON)}$	On-State Drain Current	$V_{GS} = -4.5\text{V}$ , $V_{DS} = -5\text{V}$ (pulse) <sup>2</sup>	-24			A
$V_{GS(th)}$	Gate Threshold Voltage	$V_{GS} = V_{DS}$ , $I_D = -250\mu\text{A}$		-0.8		V

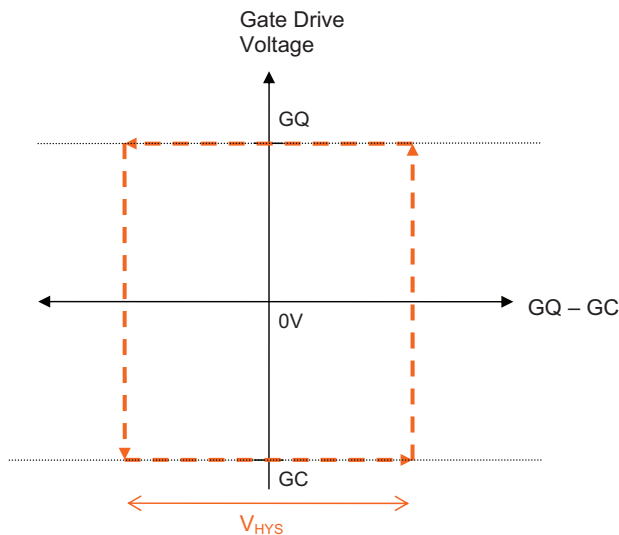

- Where  $V_{SYS}$  is the greater of  $V_D$  or  $V_S$ .
- Pulse width  $< 300\mu\text{s}$ , duty cycle  $< 1\%$ .

## 20mΩ P-Channel SmartSwitch for UMPC Battery Charging Applications

### AAT4681/-1 Typical Electrical Characteristics

**Hysteresis, GQ Ramp Time = 2.5ms**  
(S = 5.5V; GC = 0.5V; R<sub>STAT</sub> = 5K; V<sub>IO</sub> = 5.5V)

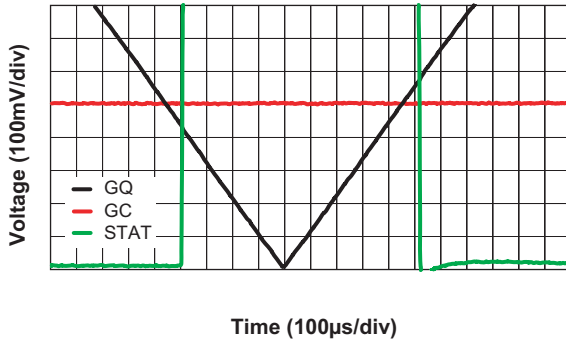

**Hysteresis, GQ Ramp Time = 500µs**  
(S = 5.5V; GC = 0.5V; R<sub>STAT</sub> = 5K; V<sub>IO</sub> = 5.5V)

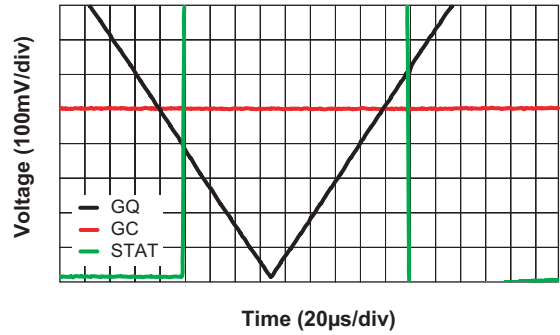

**Timing**  
(S = 5.5V; GC = 0.5V; GQ ramp time = 2.5ms;  
R<sub>STAT</sub> = 5K; V<sub>IO</sub> = 5.5V)

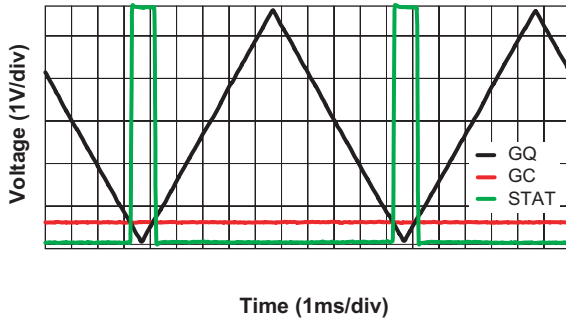

**Shutdown Current vs. Shutdown Voltage**

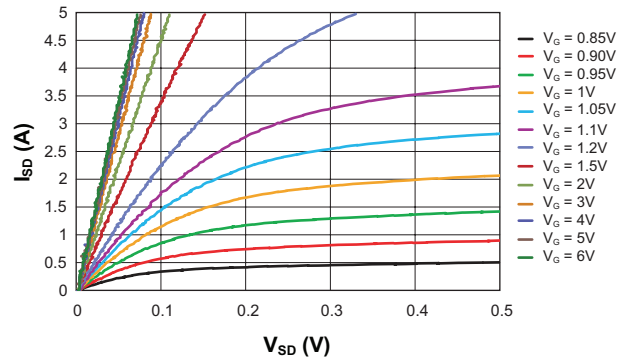

**R<sub>DS(ON)</sub> vs. I<sub>SD</sub>**

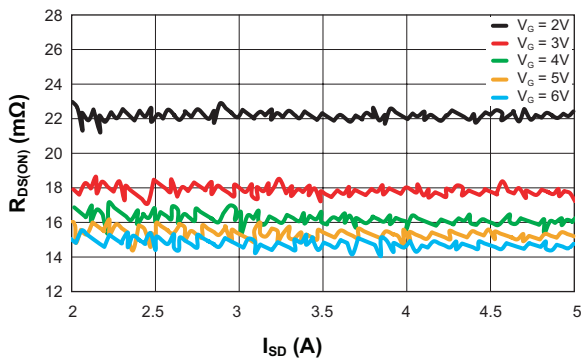

**On-Resistance vs. Junction Temperature**  
(V<sub>S</sub> = 6V; I<sub>DS</sub> = 5A; Pulse width <300µs; Duty Cycle <1%)

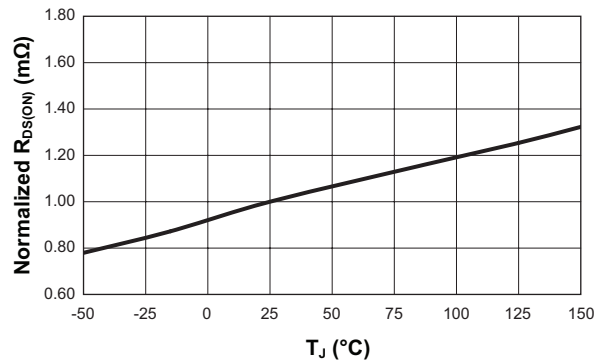

## 20mΩ P-Channel SmartSwitch for UMPC Battery Charging Applications

### AAT4681/-1 Typical Electrical Characteristics

**On-Resistance vs. Gate Voltage  $G_C$**

$(V_S = 6V; V_{GQ} = 0V, I_{DS} = 5A;$   
Pulse Width < 300μs, Duty Cycle < 1%)

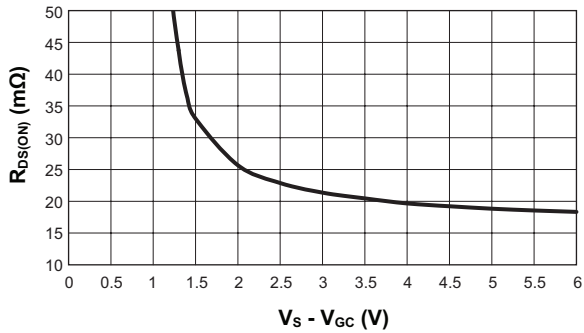

**On-Resistance vs. Gate Voltage  $G_C$**

$V_S = 6V, V_{Gc} = 0V, I_{DS} = 5A;$   
Pulse Width < 300μs, Duty Cycle < 1%)

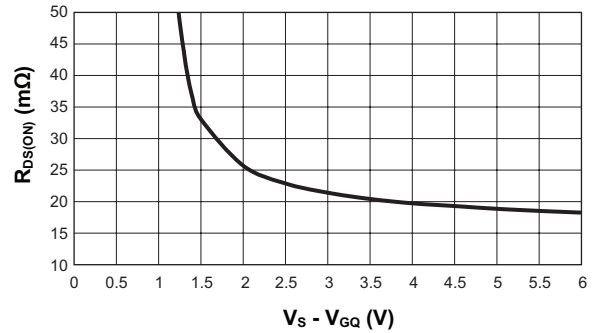

**On-Resistance vs. Gate Voltage  $G_C$**

$V_S = 6V, V_{GQ} = 0V, I_{DS} = 7A;$   
Pulse Width < 300μs, Duty Cycle < 1%)

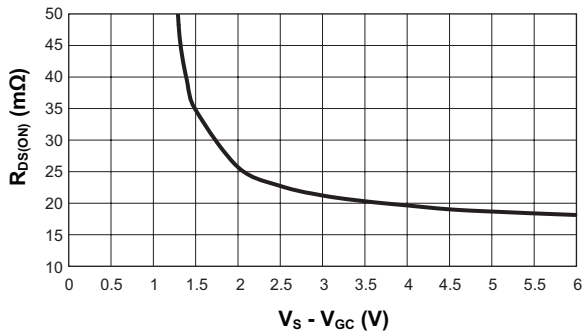

**On-Resistance vs. Gate Voltage  $G_Q$**

$V_S = 6V, V_{GQ} = 0V, I_{DS} = 7A;$   
Pulse Width < 300μs, Duty Cycle < 1%)

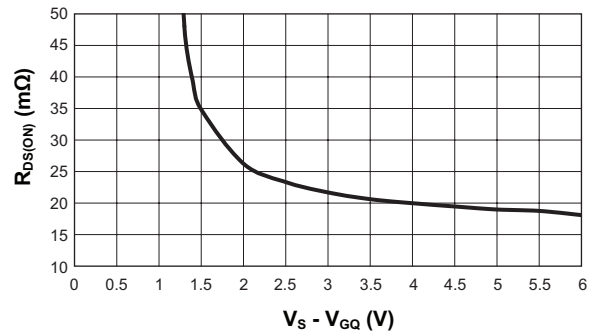

## 20mΩ P-Channel SmartSwitch for UMPC Battery Charging Applications

### AAT4681-2 Typical Electrical Characteristics

Output Characteristics

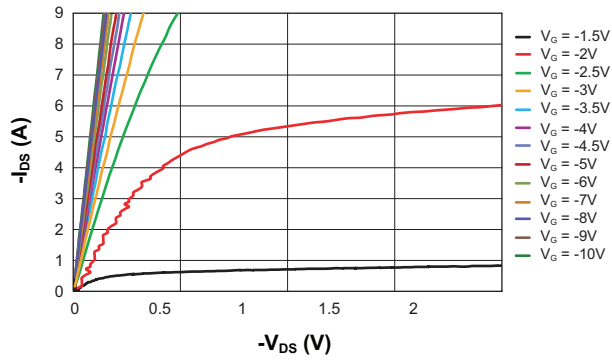

Transfer Characteristics

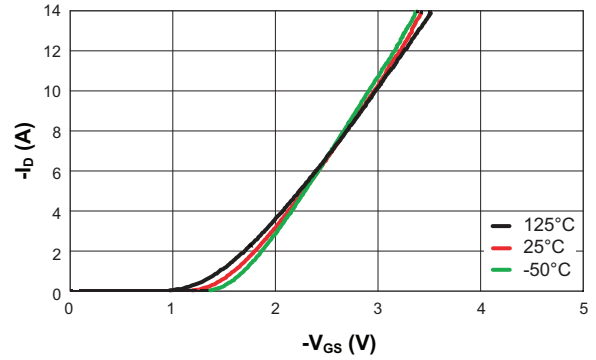

On-Resistance vs. Drain Current

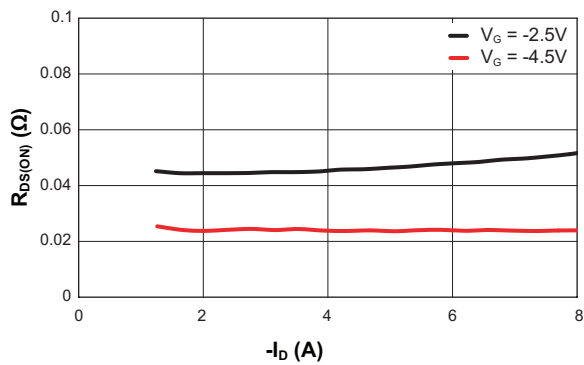

On-Resistance vs. Gate-Source Voltage

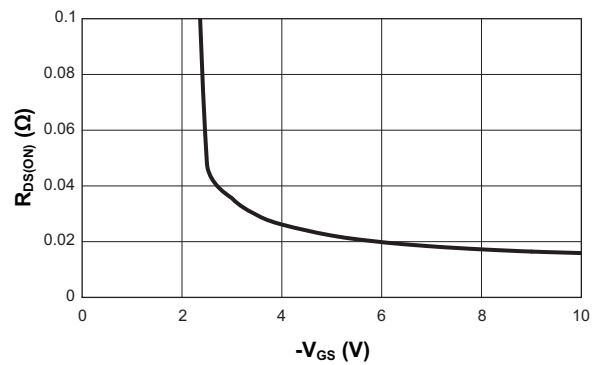

On-Resistance vs. Junction Temperature  
( $V_{GS} = -4.5V$ ;  $I_D = -5.9A$ )

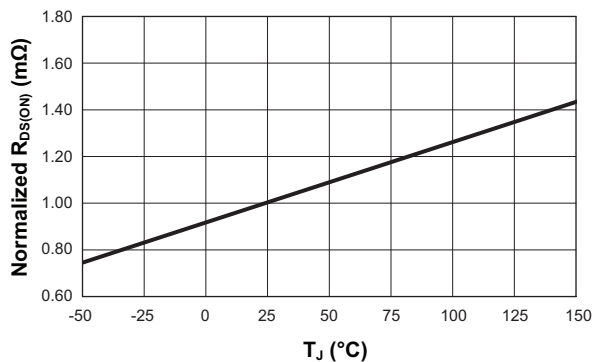

Threshold Voltage vs. Junction Temperature

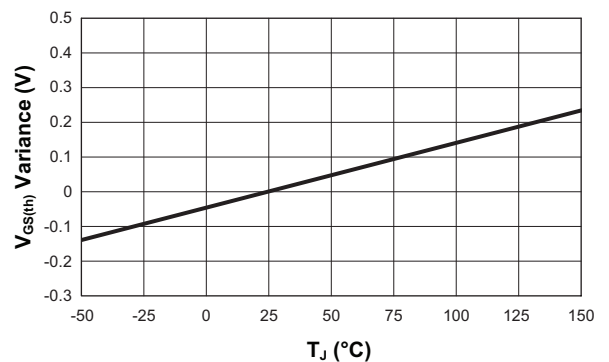

## 20mΩ P-Channel SmartSwitch for UMPC Battery Charging Applications

### AAT4681-2 Typical Electrical Characteristics

Gate Charge

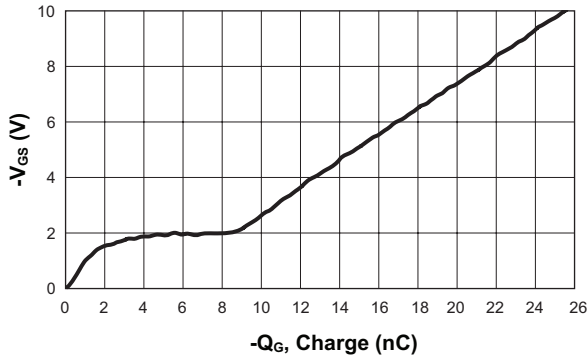

Source-Drain Diode Forward Voltage

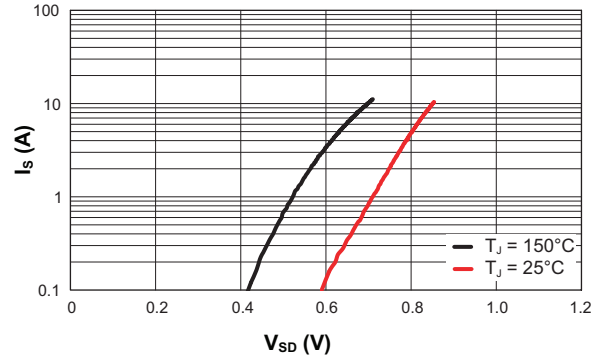





# AAT4681

## 20mΩ P-Channel SmartSwitch for UMPC Battery Charging Applications

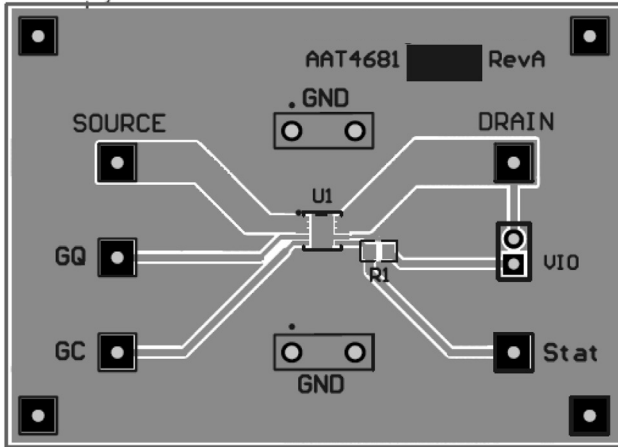

Figure 1: AAT4681IDE Evaluation Board Top Side Layout.

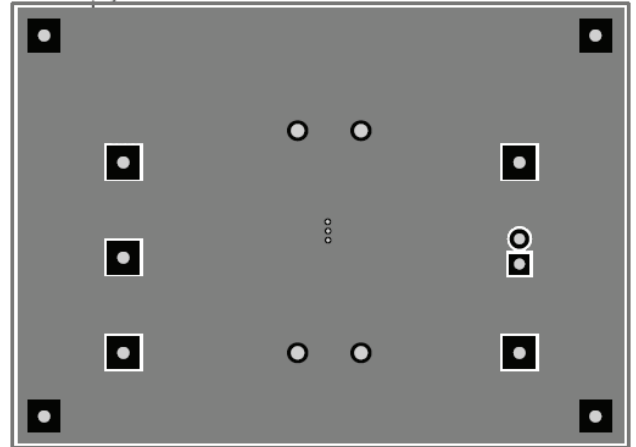

Figure 2: AAT4681IDE Evaluation Board Bottom Side Layout

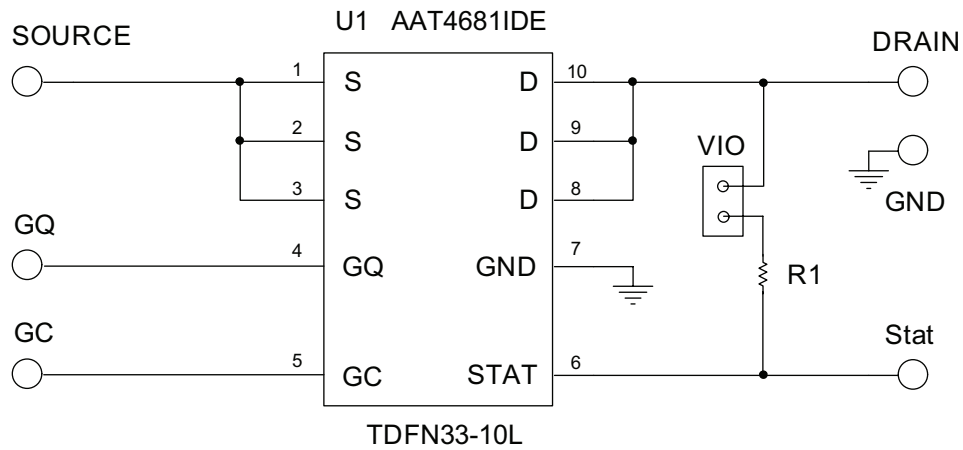

Figure 3: AAT4681IDE Evaluation Board Schematic.

## 20mΩ P-Channel SmartSwitch for UMPC Battery Charging Applications

### Ordering Information

Package	Marking <sup>1</sup>	Continuous Drain Current (A)	Part Number (Tape and Reel) <sup>2</sup>
TDFN33-10L	J8XYY	±7.0 <sup>3</sup>	<b>AAT4681IDE-T1</b>
TDFN33-10L	F5XYY	±5.0 <sup>3</sup>	<b>AAT4681IDE-1-T1</b>
TDFN33-10L	Y4XYY	±3.2 <sup>4</sup>	<b>AAT4681IDE-2-T1</b>



Skyworks Green™ products are compliant with all applicable legislation and are halogen-free.

For additional information, refer to *Skyworks Definition of Green™*, document number SQ04-0074.

### Package Information

#### TDFN33-10L<sup>5</sup>

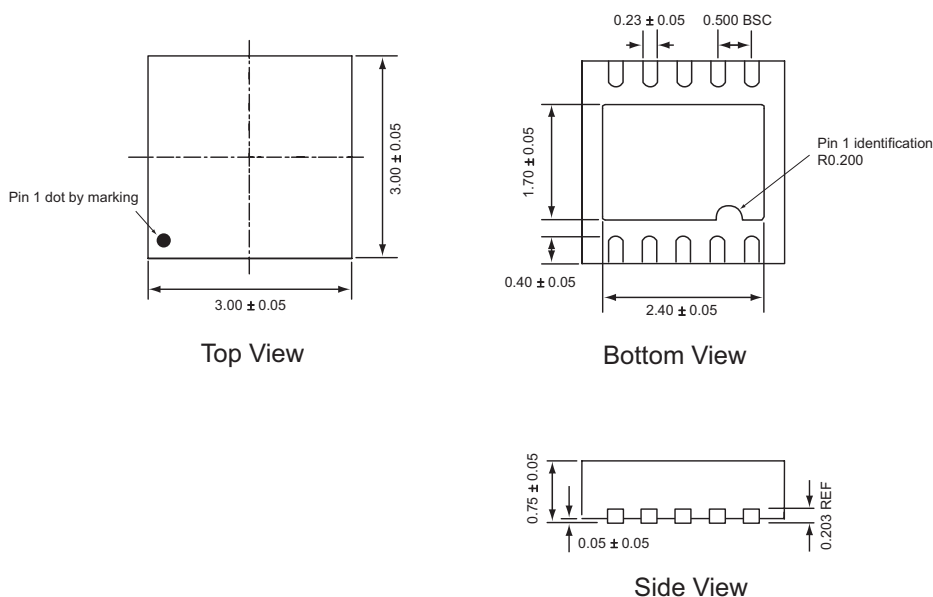

All dimensions in millimeters.

1. XYY = assembly and date code.
2. Sample stock is generally held on part numbers listed in **BOLD**.
3.  $T_A = 85^\circ\text{C}$ .
4.  $T_A = 70^\circ\text{C}$ .
5. The leadless package family, which includes QFN, TQFN, DFN, TDFN and STDFN, has exposed copper (unplated) at the end of the lead terminals due to the manufacturing process. A solder fillet at the exposed copper edge cannot be guaranteed and is not required to ensure a proper bottom solder connection.

---

**20mΩ P-Channel SmartSwitch for UMPC Battery Charging Applications**

Copyright © 2012 Skyworks Solutions, Inc. All Rights Reserved.

Information in this document is provided in connection with Skyworks Solutions, Inc. ("Skyworks") products or services. These materials, including the information contained herein, are provided by Skyworks as a service to its customers and may be used for informational purposes only by the customer. Skyworks assumes no responsibility for errors or omissions in these materials or the information contained herein. Skyworks may change its documentation, products, services, specifications or product descriptions at any time, without notice. Skyworks makes no commitment to update the materials or information and shall have no responsibility whatsoever for conflicts, incompatibilities, or other difficulties arising from any future changes.

No license, whether express, implied, by estoppel or otherwise, is granted to any intellectual property rights by this document. Skyworks assumes no liability for any materials, products or information provided hereunder, including the sale, distribution, reproduction or use of Skyworks products, information or materials, except as may be provided in Skyworks Terms and Conditions of Sale.

THE MATERIALS, PRODUCTS AND INFORMATION ARE PROVIDED "AS IS" WITHOUT WARRANTY OF ANY KIND, WHETHER EXPRESS, IMPLIED, STATUTORY, OR OTHERWISE, INCLUDING FITNESS FOR A PARTICULAR PURPOSE OR USE, MERCHANTABILITY, PERFORMANCE, QUALITY OR NON-INFRINGEMENT OF ANY INTELLECTUAL PROPERTY RIGHT; ALL SUCH WARRANTIES ARE HEREBY EXPRESSLY DISCLAIMED. SKYWORKS DOES NOT WARRANT THE ACCURACY OR COMPLETENESS OF THE INFORMATION, TEXT, GRAPHICS OR OTHER ITEMS CONTAINED WITHIN THESE MATERIALS. SKYWORKS SHALL NOT BE LIABLE FOR ANY DAMAGES, INCLUDING BUT NOT LIMITED TO ANY SPECIAL, INDIRECT, INCIDENTAL, STATUTORY, OR CONSEQUENTIAL DAMAGES, INCLUDING WITHOUT LIMITATION, LOST REVENUES OR LOST PROFITS THAT MAY RESULT FROM THE USE OF THE MATERIALS OR INFORMATION, WHETHER OR NOT THE RECIPIENT OF MATERIALS HAS BEEN ADVISED OF THE POSSIBILITY OF SUCH DAMAGE.

Skyworks products are not intended for use in medical, lifesaving or life-sustaining applications, or other equipment in which the failure of the Skyworks products could lead to personal injury, death, physical or environmental damage. Skyworks customers using or selling Skyworks products for use in such applications do so at their own risk and agree to fully indemnify Skyworks for any damages resulting from such improper use or sale.

Customers are responsible for their products and applications using Skyworks products, which may deviate from published specifications as a result of design defects, errors, or operation of products outside of published parameters or design specifications. Customers should include design and operating safeguards to minimize these and other risks. Skyworks assumes no liability for applications assistance, customer product design, or damage to any equipment resulting from the use of Skyworks products outside of stated published specifications or parameters.

Skyworks, the Skyworks symbol, and "Breakthrough Simplicity" are trademarks or registered trademarks of Skyworks Solutions, Inc., in the United States and other countries. Third-party brands and names are for identification purposes only, and are the property of their respective owners. Additional information, including relevant terms and conditions, posted at [www.skyworksinc.com](http://www.skyworksinc.com), are incorporated by reference.