

ASSEMBLY - VIEW FROM FRONT

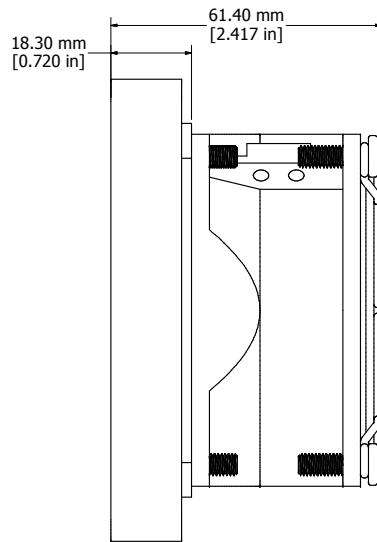

ASSEMBLY - VIEW FROM SIDE

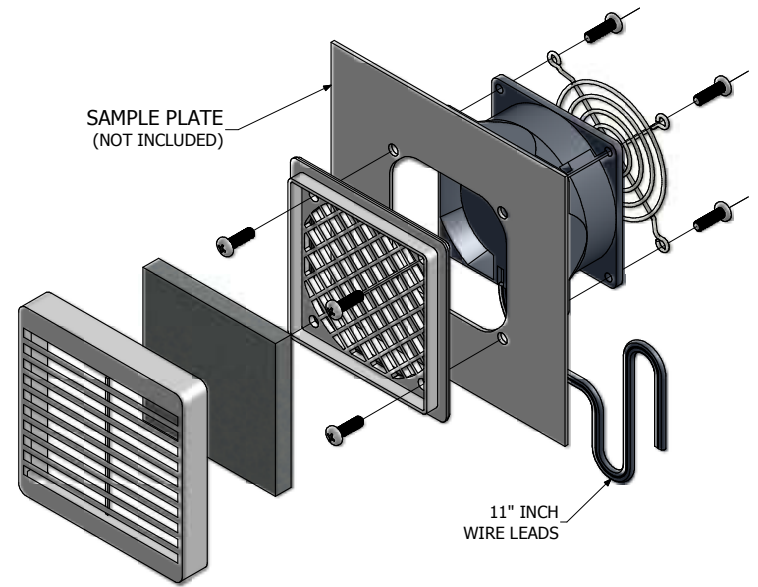

EXPLODED ISOMETRIC VIEW

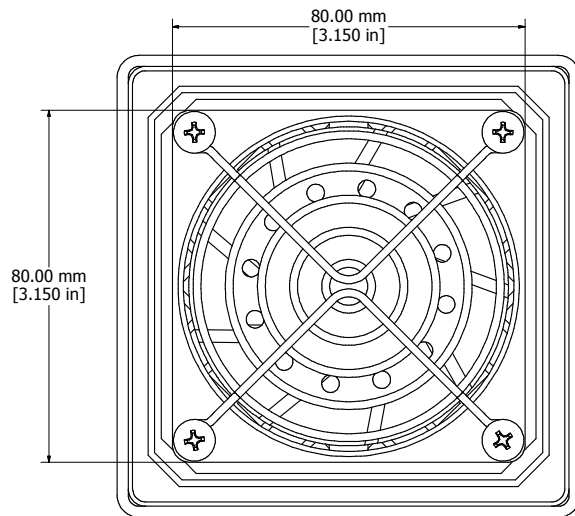

ASSEMBLY - VIEW FROM BACK

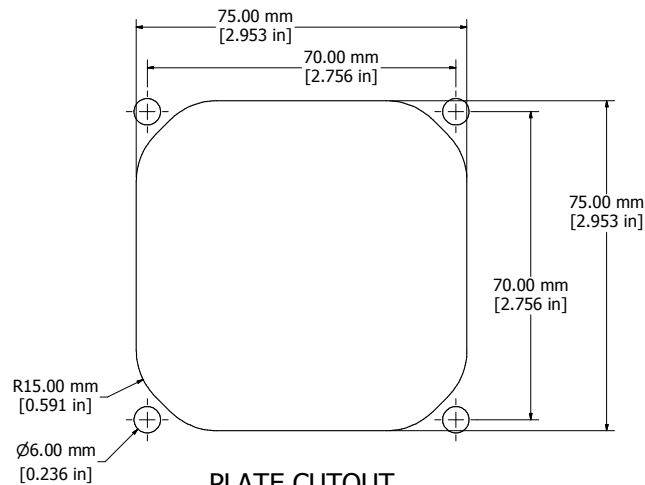

PLATE CUTOUT

DNFF080**115
Finish - Front Screen - ABS Plastic - Back Panel - ABS Plastic
Rated - 115 VAC, 50/60 Hz, 0.09 Amps Free Flow Air Delivery - 32 CFM
Colours
DNFF080BK115 - Black
DNFF080CG115 - Gray/Beige
DNFF080GY115 - Gray
DNFF080LG115 - Light Gray
Hardware
8 Screws - Panhead Self-tapping 10-32 x 1/2" 4 Speed Nuts

