

RX-LS200

Related Information

- General terms and conditions F-7
- Sensor selection guide.....P.271~
- Glossary of terms..... P.1455~
- General precautions..... P.1458~

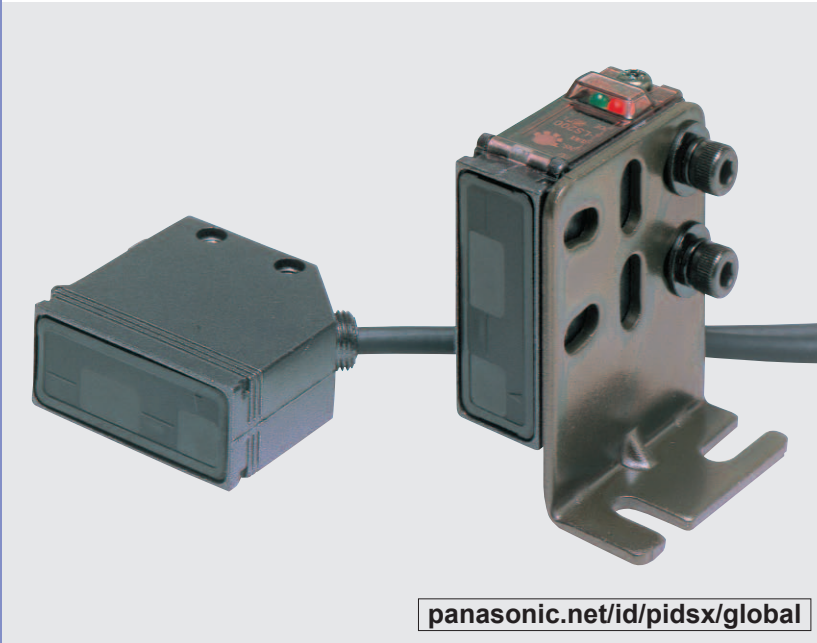

Detection of different colored objects at a certain distance

Hardly affected by color

The color or size of the object does not affect its sensing performance.

Robust

Its robust enclosure is made of die-cast zinc alloy.

Hardly affected by background

The sensor does not detect the background beyond the set distance since it is of distance adjustable type.

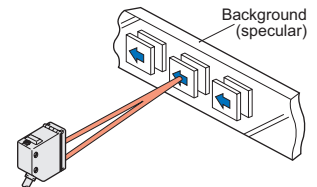

(However, changing the angle of the sensor is necessary when the background object has a specular surface.)

ENVIRONMENTAL RESISTANCE

Waterproof IP67 (IEC)

The equipment on which the sensor is mounted can be washed without any problem.

Note: However, take care that if it is exposed to water splashes during operation. It may detect a water drop itself.

Insusceptible to dust

The sensing performance is less affected by dust as it does not depend on the incident light intensity.

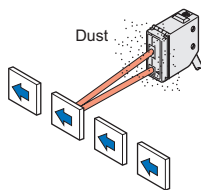

BASIC PERFORMANCE

High-speed response time: 1 ms

It can be used on a high speed assembly line.

Adjustable Range & Fixed-focus Reflective Type

The sensing range for which the sensor detects an object is determined by the incident beam angle, regardless of the incident light intensity.

RX-LS200

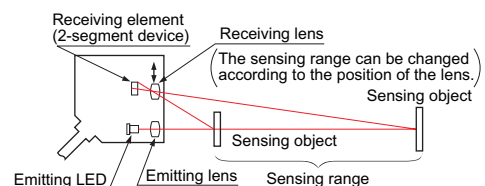

- FIBER SENSORS
- LASER SENSORS
- PHOTOELECTRIC SENSORS
- MICRO PHOTOELECTRIC SENSORS
- AREA SENSORS
- LIGHT CURTAINS / SAFETY COMPONENTS
- PRESSURE / FLOW SENSORS
- INDUCTIVE PROXIMITY SENSORS
- PARTICULAR USE SENSORS
- SENSOR OPTIONS
- SIMPLE WIRE-SAVING UNITS
- WIRE-SAVING SYSTEMS
- MEASUREMENT SENSORS
- STATIC ELECTRICITY PREVENTION DEVICES
- LASER MARKERS
- PLC
- HUMAN MACHINE INTERFACES
- ENERGY CONSUMPTION VISUALIZATION COMPONENTS
- FA COMPONENTS
- MACHINE VISION SYSTEMS
- UV CURING SYSTEMS

- Selection Guide
- Amplifier Built-in
- Power Supply Built-in
- Amplifier-separated
- CX-400
- CY-100
- EX-10
- EX-20
- EX-30
- EX-40
- CX-440
- EQ-30
- EQ-500
- MQ-W
- RX-LS200**
- RX
- RT-610

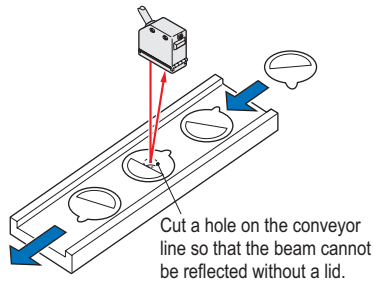
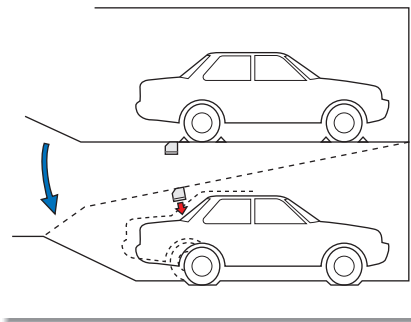
APPLICATIONS**Detecting lids of cups****Safekeeping at parking garage****ORDER GUIDE**

Type	Appearance	Sensing range	Model No.	Output
NPN output		50 to 200 mm 1.969 to 7.874 in	RX-LS200	NPN open-collector transistor
PNP output			RX-LS200-P	PNP open-collector transistor

5 m cable length type

5 m **16.404 ft** cable length type (standard: 3 m **9.843 ft**) is also available for NPN output type.
Model No.: **RX-LS200-C5**

Accessory

- **MS-RX-1** (Sensor mounting bracket)

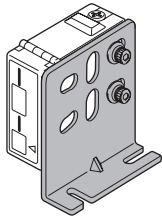

Two M4 (length 16 mm **0.630 in**) hexagon-socket-head bolts are attached.

OPTIONS

Designation	Model No.	Description		
Narrow-view slit mask	OS-RXL-1	Slit size	The sensing view is narrowed laterally so that the effect of the object's surroundings is reduced.	
	OS-RXL-2			2.5 × 24 mm 0.098 0.945 in
	OS-RXL-3			3.0 × 24 mm 0.118 0.945 in
Protective tube	PT-RX500	Length	Cable is protected from external forces. It does not rust as it is made of stainless steel.	
	PT-RX1000			3.5 × 24 mm 0.138 0.945 in

Narrow-view slit mask

- **OS-RXL-□**

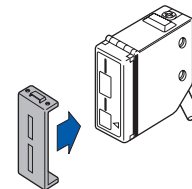
**Protective tube**

- **PT-RX500**
- **PT-RX1000**

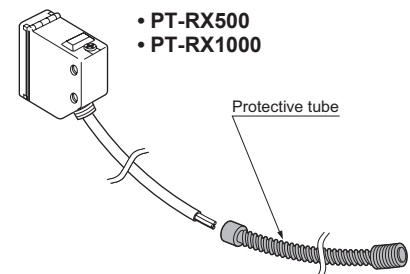
FIBER
SENSORSLASER
SENSORSPHOTO-
ELECTRIC
SENSORSMICRO
PHOTO-
ELECTRIC
SENSORSAREA
SENSORSLIGHT
CURTAINS /
SAFETY
COMPONENTSPRESSURE /
FLOW
SENSORSINDUCTIVE
PROXIMITY
SENSORSPARTICULAR
USE
SENSORSSENSOR
OPTIONSSIMPLE
WIRE-SAVING
UNITSWIRE-SAVING
SYSTEMSMEASURE-
MENT
SENSORSSTATIC
ELECTRICITY
PREVENTION
DEVICESLASER
MARKERS

PLC

HUMAN
MACHINE
INTERFACESENERGY
CONSUMPTION
VISUALIZATION
COMPONENTSFA
COMPONENTSMACHINE
VISION
SYSTEMSUV
CURING
SYSTEMSSelection
GuideAmplifier
Built-inPower Supply
Built-inAmplifier-
separated**CX-400****CY-100****EX-10****EX-20****EX-30****EX-40****CX-440****EQ-30****EQ-500****MQ-W****RX-LS200****RX****RT-610**

SPECIFICATIONS

Type		Adjustable range reflective	
		NPN output type	PNP output type
Item	Model No.	RX-LS200	RX-LS200-P
Sensing range		50 to 200 mm 1.969 to 7.874 in with white non-glossy paper (50 × 50 mm 1.969 × 1.969 in)	
Hysteresis		10 % or less of operation distance with white non-glossy paper (50 × 50 mm 1.969 × 1.969 in)	
Repeatability		Along sensing axis: 1 mm 0.039 in or less, Perpendicular to sensing axis: 0.5 mm 0.020 in or less	
Supply voltage		12 to 24 V DC ±10 % Ripple P-P 10 % or less	
Current consumption		40 mA or less	
Output		NPN open-collector transistor <ul style="list-style-type: none"> • Maximum sink current: 100 mA • Applied voltage: 30 V DC or less (between output and 0 V) • Residual voltage: 1.5 V or less (at 100 mA sink current) 0.4 V or less (at 16 mA sink current) 	PNP open-collector transistor <ul style="list-style-type: none"> • Maximum source current: 100 mA • Applied voltage: 30 V DC or less (between output and +V) • Residual voltage: 1 V or less (at 100 mA source current) 0.4 V or less (at 16 mA source current)
Utilization category		DC-12 or DC-13	
Output operation		Switchable either Light-ON or Dark-ON	
Short-circuit protection		Incorporated	
Response time		1 ms or less	
Operation indicator		Red LED (lights up when the output is ON)	
Stability indicator		Green LED (lights up under stable light received condition or stable dark condition)	
Distance adjuster		2-turn mechanical adjuster	
Environmental resistance	Pollution degree	3 (Industrial environment)	
	Protection	IP67 (IEC)	
	Ambient temperature	-25 to 60 °C -13 to 140 °F (No dew condensation or icing allowed), Storage: -30 to 70 °C -22 to 158 °F	
	Ambient humidity	35 to 85 % RH, Storage: 35 to 85 % RH	
	Ambient illuminance	Incandescent light: 3,500 lx at the light-receiving face	
	EMC	EN 60947-5-2	
	Voltage withstandability	1,000 V AC for one min. between all supply terminals connected together and enclosure	
	Insulation resistance	20 MΩ, or more, with 250 V DC megger between all supply terminals connected together and enclosure	
	Vibration resistance	10 to 500 Hz frequency, 1.5 mm 0.059 in amplitude (10 G max.) in X, Y and Z directions for two hours each	
	Shock resistance	500 m/s ² acceleration (50 G approx.) in X, Y and Z directions for three times each	
Emitting element		Infrared LED (peak emission wavelength: 880 nm 0.035mil , modulated)	
Material		Enclosure: Die-cast zinc alloy, Indicator cover: Polyethersulphone, Lens: Polycarbonate	
Cable		0.15 mm ² 3-core oil, heat and cold resistant cabtyre cable, 3 m 9.843 ft long	
Cable extension		Extension up to total 100 m 328.084 ft is possible with 0.3 mm ² , or more, cable.	
Weight		Net weight: 85 g approx.	
Accessories		MS-RX-1 (Sensor mounting bracket): 1 set, Adjusting screwdriver: 1 pc.	

Note: Where measurement conditions have not been specified precisely, the conditions used were an ambient temperature of +23 °C **+73.4 °F**.

I/O CIRCUIT AND WIRING DIAGRAMS

RX-LS200 NPN output type

I/O circuit diagram

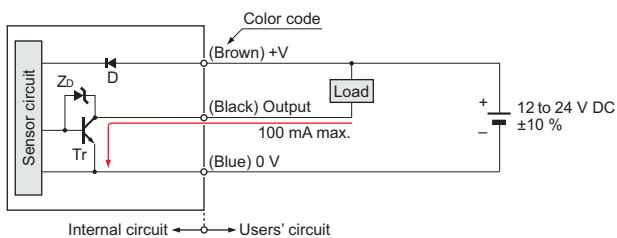

Wiring diagram

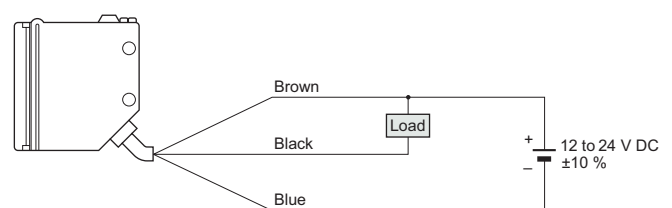

Symbols ... D : Reverse supply polarity protection diode
 ZD: Surge absorption zener diode
 Tr : NPN output transistor

FIBER SENSORS
 LASER SENSORS
 PHOTO-ELECTRIC SENSORS
 MICRO PHOTO-ELECTRIC SENSORS
 AREA SENSORS
 LIGHT CURTAINS / SAFETY COMPONENTS
 PRESSURE / FLOW SENSORS
 INDUCTIVE PROXIMITY SENSORS
 PARTICULAR USE SENSORS
 SENSOR OPTIONS
 SIMPLE WIRE-SAVING UNITS
 WIRE-SAVING SYSTEMS
 MEASURE-MENT SENSORS
 STATIC ELECTRICITY PREVENTION DEVICES
 LASER MARKERS
 PLC
 HUMAN MACHINE INTERFACES
 ENERGY CONSUMPTION VISUALIZATION COMPONENTS
 FA COMPONENTS
 MACHINE VISION SYSTEMS
 UV CURING SYSTEMS
 Selection Guide
 Amplifier Built-in
 Power Supply Built-in
 Amplifier-separated
 CX-400
 CY-100
 EX-10
 EX-20
 EX-30
 EX-40
 CX-440
 EQ-30
 EQ-500
 MQ-W
 RX-LS200
 RX
 RT-610

I/O CIRCUIT AND WIRING DIAGRAMS**RX-LS200-P**

PNP output type

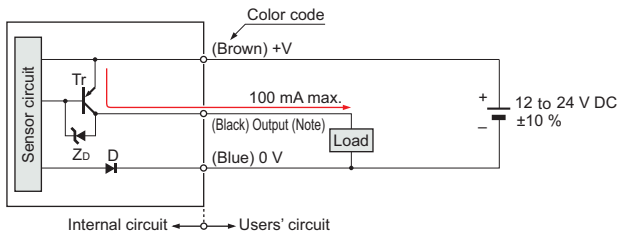
I/O circuit diagram

Note: The output does not incorporate a short-circuit protection circuit.
Do not connect it directly to a power supply or a capacitive load.

Symbols ... D : Reverse supply polarity protection diode
Zd : Surge absorption zener diode
Tr : PNP output transistor

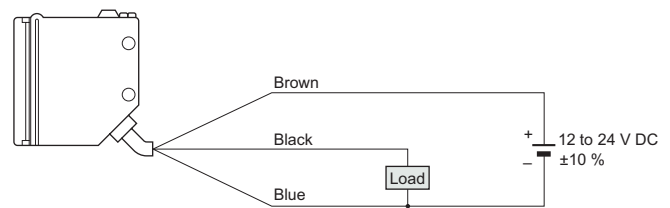
Wiring diagram**SENSING CHARACTERISTICS (TYPICAL)****Sensing fields**

- Setting distance: 200 mm
7.874 in (Horizontal)

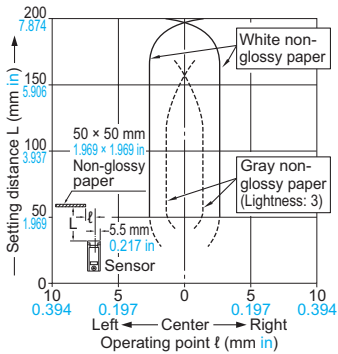

- Setting distance: 200 mm
7.874 in (Vertical)

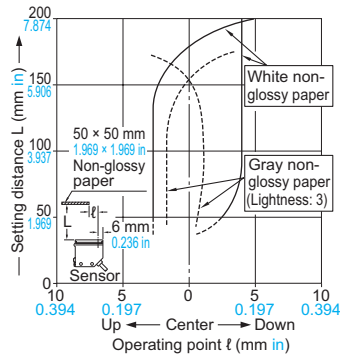

- Setting distance: 150 mm
5.906 in (Horizontal)

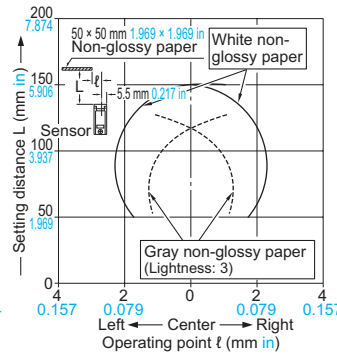

- Setting distance: 150 mm
5.906 in (Vertical)

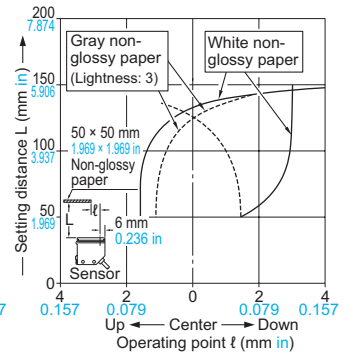

- Setting distance: 150 mm
5.906 in with slit mask
(Horizontal)

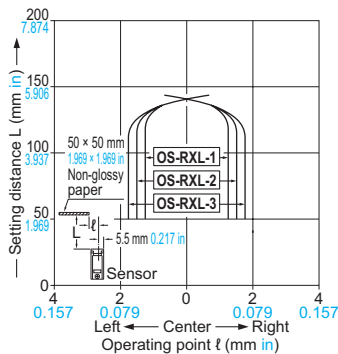

- Setting distance: 150 mm
5.906 in with slit mask
(Vertical)

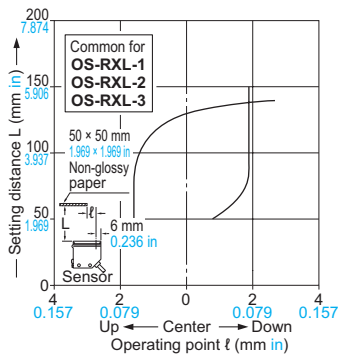
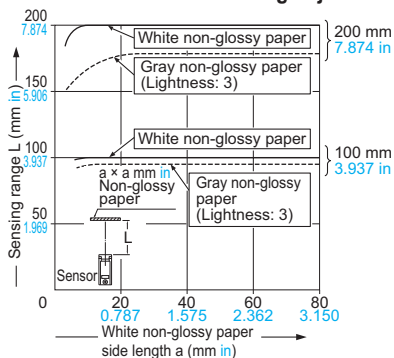
**Correlation between sensing object size and sensing range**

These curves show the characteristics with the maximum sensing range set to 100 mm 3.937 in, 200 mm 7.874 in, each, with white non-glossy paper (50 × 50 mm 1.969 × 1.969 in).

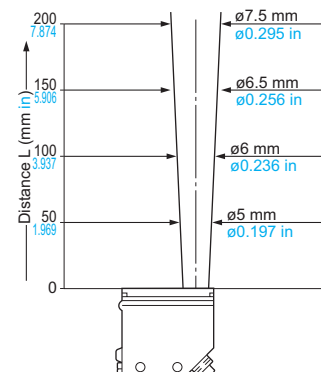
Emitted beamFIBER
SENSORSLASER
SENSORSPHOTO-
ELECTRIC
SENSORSMICRO
PHOTO-
ELECTRIC
SENSORSAREA
SENSORSLIGHT
CURTAINS /
SAFETY
COMPONENTSPRESSURE /
FLOW
SENSORSINDUCTIVE
PROXIMITY
SENSORSPARTICULAR
USE
SENSORSSENSOR
OPTIONSSIMPLE
WIRE-SAVING
UNITSWIRE-SAVING
SYSTEMSMEASURE-
MENT
SENSORSSTATIC
ELECTRICITY
PREVENTION
DEVICESLASER
MARKERS

PLC

HUMAN
MACHINE
INTERFACESENERGY
CONSUMPTION
VISUALIZATION
COMPONENTSFA
COMPONENTSMACHINE
VISION
SYSTEMSUV
CURING
SYSTEMSSelection
GuideAmplifier
Built-inPower Supply
Built-inAmplifier-
separated

CX-400

CY-100

EX-10

EX-20

EX-30

CX-440

EQ-30

EQ-500

MQ-W

RX-LS200

RX

RT-610

SENSING CHARACTERISTICS (TYPICAL)

Correlation between material (50 × 50 mm 1.969 × 1.969 in) and sensing range

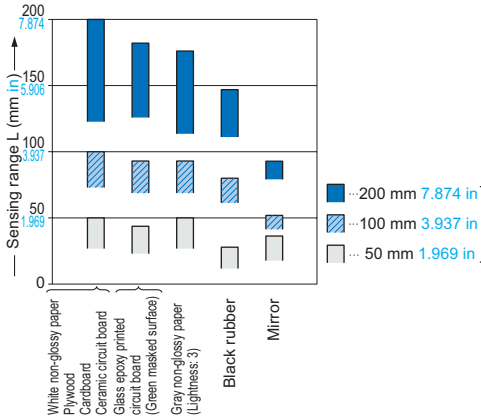

These bars indicate the sensing range with respective objects when the distance adjuster is set at the sensing range of 200 mm 7.874 in, 100 mm 3.937 in and 50 mm 1.969 in long, each, with white non-glossy paper.

PRECAUTIONS FOR PROPER USE

Refer to p.1458~ for general precautions.



- Never use this product as a sensing device for personnel protection.
- In case of using sensing devices for personnel protection, use products which meet laws and standards, such as OSHA, ANSI or IEC etc., for personnel protection applicable in each region or country.

- If a specular body is present in the background, wrong operation may be caused due to a small change in the angle of the background body. In that case, install the sensor at an inclination and confirm the operation with the actual sensing object.
- Do not install the sensor at a distance of less than 50 mm 1.969 in from the object because the sensing is unstable in this range.

Mounting

- The tightening torque should be 1.17 N·m or less.

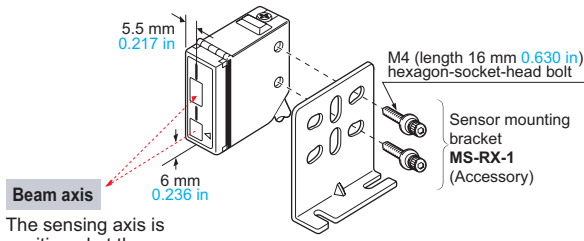

The sensing axis is positioned at the intersection of the "Δ" mark on the lens face and the "I" line.

- Care must be taken regarding the sensor mounting direction with respect to the object's direction of movement.

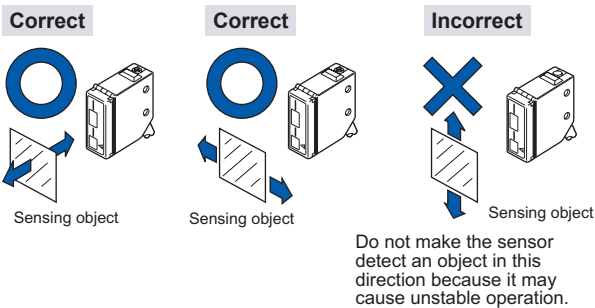

- When detecting a specular object (aluminum or copper foil) or an object having a glossy surface or coating, please take care that there are cases when the object may not be detected due to a small change in angle, wrinkles on the object surface, etc.
- When a specular body is present below the sensor, use the sensor by tilting it slightly upwards to avoid wrong operation.

Wiring

- The output of **RX-LS200-P** does not incorporate a short-circuit protection circuit. Do not connect it directly to a power supply or a capacitive load.

Use conditions to comply with CE Marking

- Following work must be done in case of using this product as a CE marking (European standard EMC Directive) conforming product.

Ensure that the shield is connected to 0 V or the actual ground.

- In case of connecting a sensor to power supply 0 V by using a shield (piping, etc.)

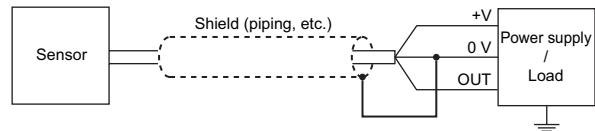

Note: The shield (piping, etc.) must be insulated.

- In case of grounding by using a shield (piping, etc.)

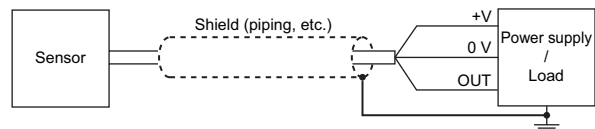

Others

- Do not use during the initial transient time (50 ms) after the power supply is switched on.

FIBER SENSORS
LASER SENSORS
PHOTO-ELECTRIC SENSORS
MICRO PHOTO-ELECTRIC SENSORS
AREA SENSORS
LIGHT CURTAINS/SAFETY COMPONENTS
PRESSURE / FLOW SENSORS
INDUCTIVE PROXIMITY SENSORS
PARTICULAR USE SENSORS
SENSOR OPTIONS
SIMPLE WIRE-SAVING UNITS
WIRE-SAVING SYSTEMS
MEASURE-MENT SENSORS
STATIC ELECTRICITY PREVENTION DEVICES
LASER MARKERS
PLC
HUMAN MACHINE INTERFACES
ENERGY CONSUMPTION VISUALIZATION COMPONENTS
FA COMPONENTS
MACHINE VISION SYSTEMS
UV CURING SYSTEMS
Selection Guide
Amplifier Built-in
Power Supply Built-in
Amplifier-separated
CX-400
CY-100
EX-10
EX-20
EX-30
EX-40
CX-440
EQ-30
EQ-500
MQ-W
RX-LS200
RX
RT-610

PRECAUTIONS FOR PROPER USE

Refer to p.1458~ for general precautions.

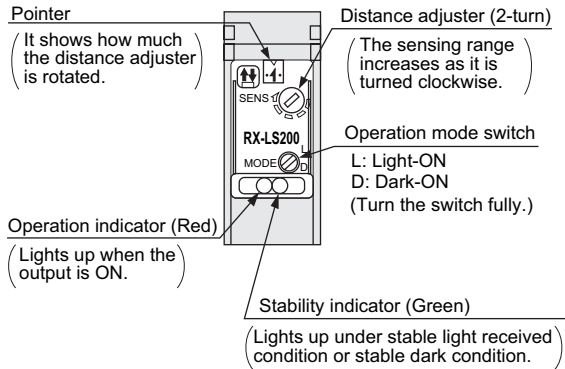
Distance adjustment**Adjusters****Adjusting procedure****<When a sensing object moves horizontally to the sensor>**

Step	Description	Distance adjuster
①	Turn the distance adjuster fully counterclockwise to the minimum sensing range position (50 mm 1.969 in approx.). (Do not turn excessively.)	Turn
②	Place an object at the required distance from the sensor, turn the distance adjuster gradually clockwise, and find out point "A" where the sensor changes to the light received condition.	
③	Remove the object, turn the distance adjuster further clockwise, and find out point "B" where the sensor changes to the light received condition again with only the background. (When the sensor does not go to the light received condition even if the adjuster is fully turned clockwise, point "B" is this extreme point.)	
④	The optimum position to stably detect objects is the center point between "A" and "B".	Optimum position

<When a sensing object is approaching / moving away from the sensor>

- Follow only steps ① and ② respectively. Since the sensing point may change depending on the sensing object, be sure to check the operation with the actual sensing object.

DIMENSIONS (Unit: mm in)

The CAD data in the dimensions can be downloaded from our website.

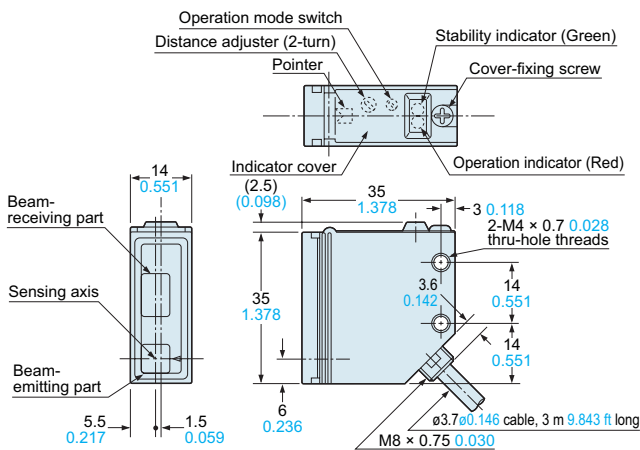
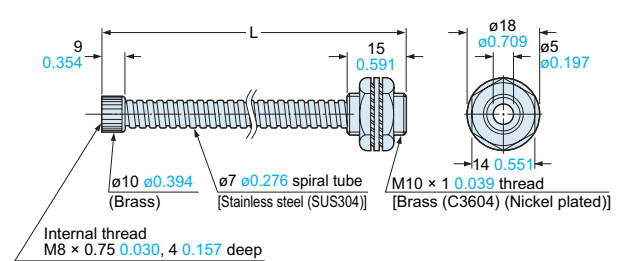
RX-LS200 RX-LS200-P Sensor**PT-RX500 PT-RX1000 Protective tube (Optional)**

• Length L

Model No.	Length L
PT-RX500	500 ⁺¹⁰ ₀ 19.685 ^{+0.394} ₀
PT-RX1000	1,000 ⁺¹⁰ ₀ 39.370 ^{+0.394} ₀

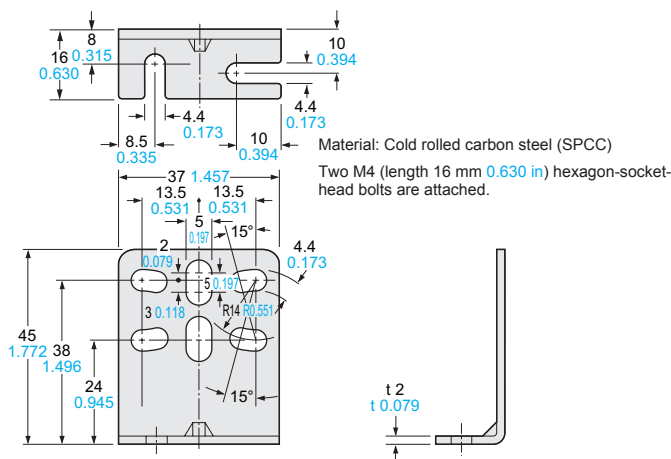
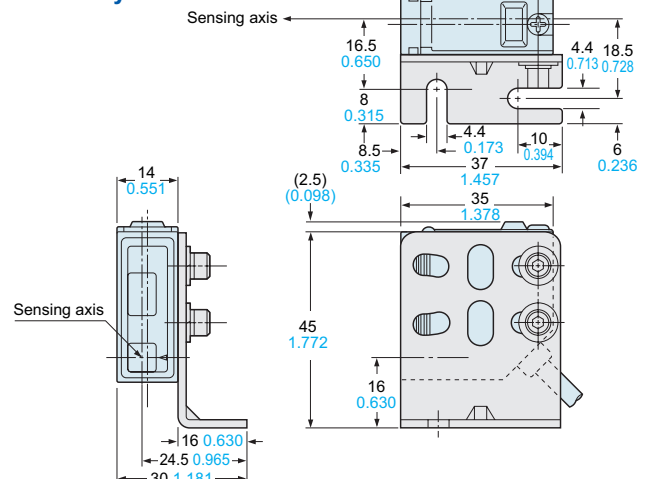
MS-RX-1**Sensor mounting bracket (Accessory)****Assembly dimensions**

FIBER SENSORS

LASER SENSORS

PHOTO-ELECTRIC SENSORS

MICRO PHOTO-ELECTRIC SENSORS

AREA SENSORS

LIGHT CURTAINS / SAFETY COMPONENTS

PRESSURE / FLOW SENSORS

INDUCTIVE PROXIMITY SENSORS

PARTICULAR USE SENSORS

SENSOR OPTIONS

SIMPLE WIRE-SAVING UNITS

WIRE-SAVING SYSTEMS

MEASUREMENT SENSORS

STATIC ELECTRICITY PREVENTION DEVICES

LASER MARKERS

PLC

HUMAN MACHINE INTERFACES

ENERGY CONSUMPTION VISUALIZATION COMPONENTS

FA COMPONENTS

MACHINE VISION SYSTEMS

UV CURING SYSTEMS

Selection Guide

Amplifier Built-in

Power Supply Built-in

Amplifier-separated

CX-400

CY-100

EX-10

EX-20

EX-30

EX-40

CX-440

EQ-30

EQ-500

MQ-W

RX-LS200

RX

RT-610