

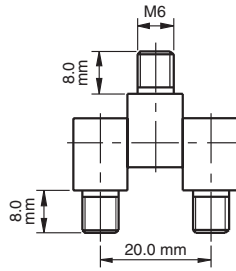

SIDE HINGE (10 mm)

Version 1

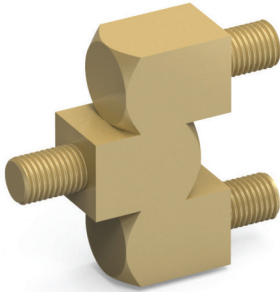

Hinge Rotation Angle

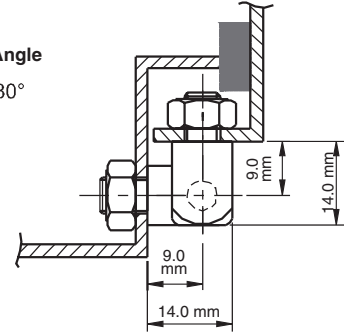
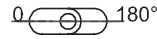

Specifications
• Material: Brass

Features
• Side-mounted hinge
• Brass 10 mm parts supplied separately.
For different dimensions contact Essentra

SIDE HINGE (12 mm)

Version 2

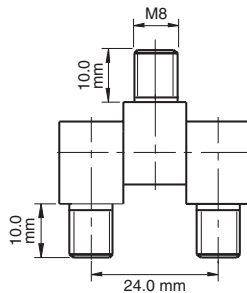
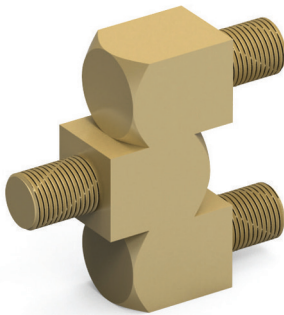

Hinge Rotation Angle

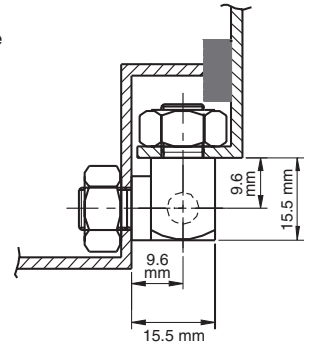

Specifications
• Material: Brass

Features
• Side-mounted hinge
• Three 12 mm brass parts supplied separately.
For different dimensions contact Essentra.

SIDE HINGE (12 mm)

Version 3

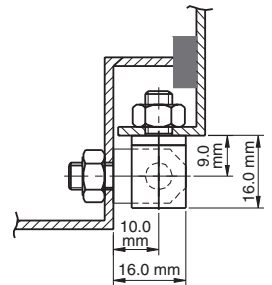
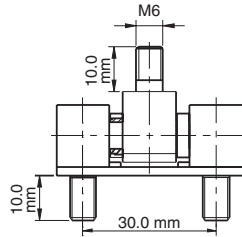
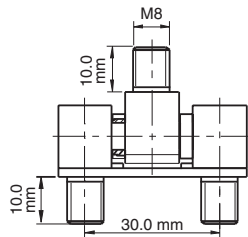
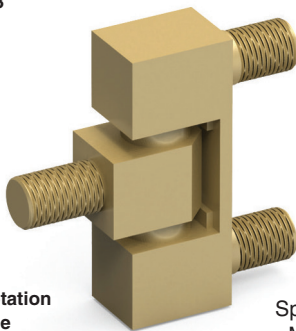

Hinge Rotation Angle

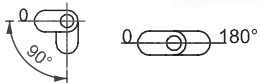

Specifications
• Material: Brass

Features
• Side-mounted hinge
• Three 12 mm brass parts supplied separately.
For different dimensions contact Essentra.
• 90° and 180° angle versions are available

Item Number	Hinge Rotation	Material	Finish	Thread	Version
09030	180°	Brass	Brass	M6	1
09034	180°	Brass	Nickel	M6	1
09130	180°	Brass	Brass	M8	2
09131	180°	Brass	Nickel	M8	2
092306180	180°	Brass	Brass	M6	3
09230690	90°	Brass	Brass	M6	3

Item Number	Hinge Rotation	Material	Finish	Thread	Version
092308180	180°	Brass	Brass	M8	3
09230890	90°	Brass	Brass	M8	3
092316180	180°	Brass	Chrome	M6	3
09231690	90°	Brass	Chrome	M6	3
092318180	180°	Brass	Chrome	M8	3
09231890	90°	Brass	Chrome	M8	3