

FRONT VIEW

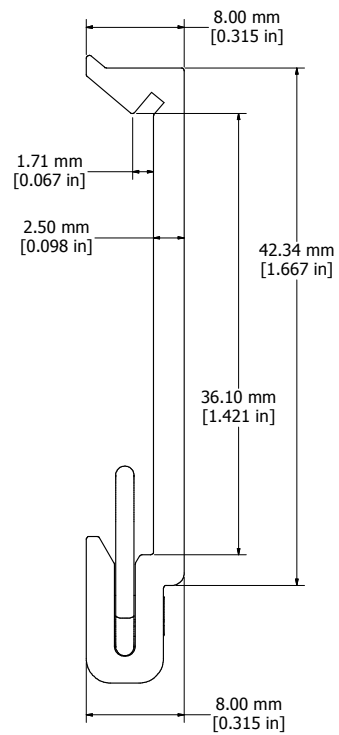

SIDE VIEW

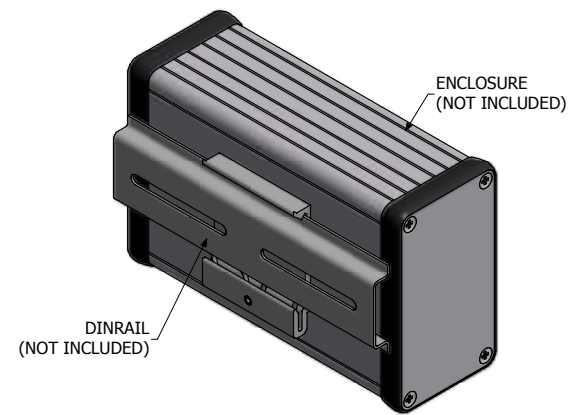

TYPICAL ASSEMBLY

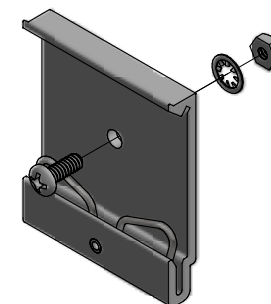

EXPLODED DINCLIP W/ HARDWARE

1427DIN42M
Material/Finish - Body - Clear Anodized Aluminum
- Spring - Galvanized Spring Steel Wire
Hardware
1 Screw - #6-32 x 3/8" Panhead
1 Nut - #6-32 Hex Nut
1 Washer - #6 Toothed Lockwasher



**HAMMOND
MANUFACTURING™**

1427DIN42M

www.hammondmfg.com