

Your Imagination. Our Innovation.

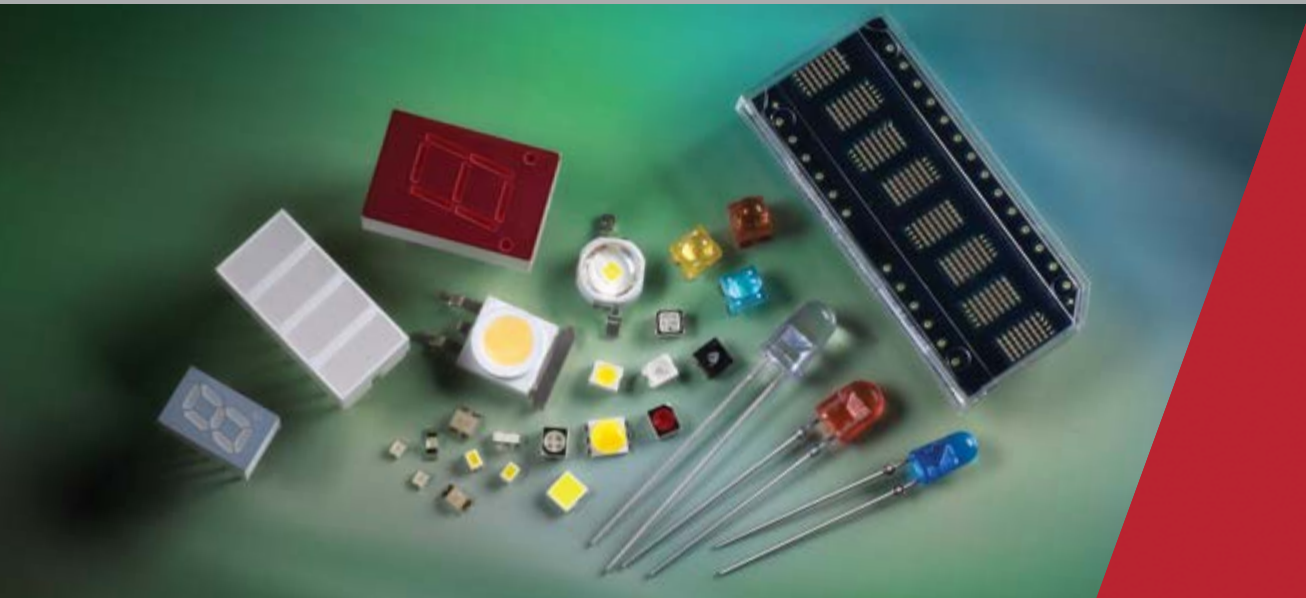

## LED Solutions

High Brightness LEDs, Indicators and Displays



Selection Guide

## LED Solutions

### High Brightness LEDs

- 2 High Brightness Through-hole Lamps
- 13 High Brightness Surface Mount Lamps
- 16 Surface Mount PLCC LEDs
- 34 Mini PLCC-2 Surface Mount LEDs
- 37 Envisium™ Surface Mount Power PLCC-4 LEDs
- 40 High Power LEDs
- 45 Moonstone™ High Power LEDs
- 48 Theialed 1W High Power LEDs

### LED Indicators and Displays

- 52 Standard Through-hole Lamps
- 57 Subminiature Lamps
- 61 Surface Mount ChipLEDs
- 70 Auto Focus Auxiliary Flash LEDs
- 73 Seven-Segment Displays
- 99 Light Bars and Bar Graph Arrays
- 103 Smart Displays

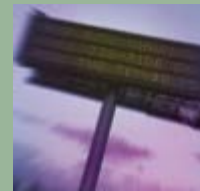

# Avago Technologies is one of the largest producers of visible light-emitting diodes in the world.

Avago Technologies offers “one-stop shopping” with its wide array of LED (Light Emitting Diodes) Solutions. With our large manufacturing base and many years of experience from our HP and Agilent days, we are one of the largest producers of visible LEDs in the world and ships billions of products annually.

Avago employs the latest in material and process technology to produce superior LEDs. Our highly acclaimed AlInGaP (aluminium indium gallium phosphide) LED material offers high brightness and stable light output over thousands of hours with excellent mean-time-before-failure (MTBF). With our cutting edge LED technology, our solution also offers dazzling blue and green colors with InGaN (indium gallium nitride) material, and very cost-effective GaP (gallium phosphide) based technology, perfect for low to moderate light output. Avago’s LEDs create brilliant lights with rich life-like colors for our customers’ applications which are longer lasting and at a globally competitive price. They are suitable for almost any applications that customers need today with wide selection of viewing and package options.

Key products range from high brightness and high power LEDs, surface mount lamps, PLCC surface mount LEDs, to standard brightness through-hole lamps, chip LEDs, flash LEDs and various LED displays. These LED Solutions address a wide range of markets, including electronic sign and signal, automotive, solid-state lighting, consumer electronics, home and mobile appliances.

For virtually all established and emerging applications, Avago Technologies has the right LED Solutions to meet your design requirements.



# High Brightness LEDs



## High Brightness Through-hole Lamps

### Description

Avago Technologies offers two types of technology based LEDs AllnGaP and InGaN which are suitable for high brightness needs. Through Hole LEDs are offered in 4 mm and 5 mm package.

These devices are casted using advance optical grade epoxy, which provides superior high temperature performance and excellent moisture resistance.

These High Brightness Through Hole LEDs are suitable for application in traffic management, solar powered variable message signs and commercial outdoor advertising video displays.

### Features and Benefits

- Excellent product quality and reliability
- Wide range of products
- Competitive pricing
- Wide operating temperature range
- Low power consumption
  - High efficiency, low drive currents and low driving voltages required.
- Colors available for AllnGaP LED lamps:  
Red (626nm), Red Orange (615nm), Orange (605nm) and Amber (590nm)
- Colors available for InGaN LED lamps:  
Blue (470nm), Green (525nm).
- Packaging options
  - Bulk
  - Ammopack

### Typical Applications

- Electronic Signs and Signals
  - Traffic Signal
  - Variable Message Sign
  - Pedestrian Signal
  - Work Zone Warning Lights
- Solar Powered Sign
- Commercial Outdoor Advertising
  - Full Color Sign
  - Mono Color Sign

# High Brightness LEDs

## High Brightness 5mm Round LED Lamp

Part Number	Color	Dominant Wavelength (nm)	Viewing Angle (°)	Standoff (Yes/NO)	Luminous Intensity (mcd) @ 20 mA		Package Drawing
					Min.	Max.	
<b>5 mm Round LED Lamps</b>							
<b>8° Viewing Angle</b>							
	Red	626	8	No	7200	21000	A
HLMP-EG10-X1000	Red	626	8	Yes	7200	21000	B
HLMP-EH08-Y2000	Red-Orange	615	8	No	9300	27000	A
HLMP-EH10-Y2000	Red-Orange	615	8	Yes	9300	27000	B
HLMP-EJ08-X1000	Orange	605	8	No	7200	21000	A
HLMP-EJ10-X1000	Orange	605	8	Yes	7200	21000	B
HLMP-EL08-X1000	Amber	590	8	No	7200	21000	A
HLMP-EL10-X1000	Amber	590	8	Yes	7200	21000	B
<b>5mm Round LED Lamps</b>							
<b>15° Viewing Angle</b>							
HLMP-EG1G-Y10DD	Red	626	15	No	9300	21000	A
HLMP-EG1H-Y10DD	Red	626	15	Yes	9300	21000	B
HLMP-EG1A-Z10DD	Red	626	15	No	12000	21000	A
HLMP-EG1B-Z10DD	Red	626	15	Yes	12000	21000	B
HLMP-EH1A-Z10DD	Red-Orange	615	15	No	12000	21000	A
HLMP-EH1B-Z10DD	Red-Orange	615	15	Yes	12000	21000	B
HLMP-EL1G-Y10DD	Amber	590	15	No	9300	21000	A
HLMP-EL1H-Y10DD	Amber	590	15	Yes	9300	21000	B
HLMP-EL1A-Z1KDD	Amber	590	15	No	12000	21000	A
HLMP-EL1B-Z1KDD	Amber	590	15	Yes	12000	21000	B
HLMP-CB1G-XZ0DD	Blue	470	15	No	7200	16000	C
	Blue	470	15	Yes	7200	16000	D
HLMP-CB1A-XY0DD	Blue	470	15	No	7200	12000	C
HLMP-CB1A-XYBDD	Blue	470	15	No	7200	12000	C
HLMP-CB1A-XYCDD	Blue	470	15	No	7200	12000	C
HLMP-CB1B-XY0DD	Blue	470	15	Yes	7200	12000	D
HLMP-CB1B-XYBDD	Blue	470	15	Yes	7200	12000	D
HLMP-CB1B-XYCDD	Blue	470	15	Yes	7200	12000	D
HLMP-CM1G-350DD	Green	525	15	No	27000	59000	C
HLMP-CM1H-350DD	Green	525	15	Yes	27000	59000	D
HLMP-CM1A-560DD	Green	525	15	No	45000	76000	C
HLMP-CM1B-560DD	Green	525	15	Yes	45000	76000	D
HLMP-CE13-24CDD	Cyan	505	15	No	21000	45000	C
HLMP-CE13-24QDD	Cyan	505	15	No	21000	45000	C
HLMP-CE14-24CDD	Cyan	505	15	Yes	21000	45000	D
HLMP-CE14-24QDD	Cyan	505	15	Yes	21000	45000	D

# High Brightness LEDs

## High Brightness 5mm Round LED Lamp

Part Number	Color	Dominant Wavelength (nm)	Viewing Angle (°)	Standoff (Yes/NO)	Luminous Intensity (mcd) @ 20 mA		Package Drawing
					Min.	Max.	
<b>15° Viewing Angle</b>							
HLMP-CE17-240DD	Cyan	505	15	No	21000	45000	C
HLMP-CE17-24CDD	Cyan	505	15		21000	45000	
HLMP-CE17-24QDD	Cyan	505	15		21000	45000	
HLMP-CE18-240DD	Cyan	505	15	Yes	21000	45000	D
HLMP-CE18-24CDD	Cyan	505	15		21000	45000	
HLMP-CE18-24QDD	Cyan	505	15		21000	45000	
<b>23° Viewing Angle</b>							
HLMP-EG2G-XZ0DD	Red	626	23	No	7200	16000	A
HLMP-EG2H-XZ0DD	Red	626	23	Yes	7200	16000	B
HLMP-EG2A-XY0DD	Red	626	23	No	7200	12000	A
HLMP-EG2B-XY0DD	Red	626	23	Yes	7200	12000	B
HLMP-EH2A-XY0DD	Red-Orange	615	23	No	7200	12000	A
HLMP-EH2B-XY0DD	Red-Orange	615	23	Yes	7200	12000	B
HLMP-EL2G-WY0DD	Amber	590	23	No	5500	12000	A
HLMP-EL2H-WY0DD	Amber	590	23	Yes	5500	12000	B
HLMP-EL2A-XYKDD	Amber	590	23	No	7200	12000	A
HLMP-EL2B-XYKDD	Amber	590	23	Yes	7200	12000	B
HLMP-CB2G-UW0DD	Blue	470	23	No	3200	7200	C
HLMP-CB2H-UW0DD	Blue	470	23	Yes	3200	7200	D
HLMP-CB2A-VW0DD	Blue	470	23	No	4200	7200	C
HLMP-CB2A-VWBDD	Blue	470	23	No	4200	7200	C
HLMP-CB2A-VWCDD	Blue	470	23	No	4200	7200	C
HLMP-CB2B-VW0DD	Blue	470	23	Yes	4200	7200	D
HLMP-CB2B-VWBDD	Blue	470	23	Yes	4200	7200	D
HLMP-CB2B-VWCDD	Blue	470	23	Yes	4200	7200	D
HLMP-CM2G-130DD	Green	525	23	No	16000	35000	C
HLMP-CM2H-130DD	Green	525	23	Yes	16000	35000	D
HLMP-CM2A-230DD	Green	525	23	No	21000	35000	C
HLMP-CM2B-230DD	Green	525	23	Yes	21000	35000	D
HLMP-CE20-Z20DD	Cyan	505	23	No	12000	27000	C
HLMP-CE20-Z2CDD	Cyan	505	23	No	12000	27000	C
HLMP-CE20-Z2QDD	Cyan	505	23	No	12000	27000	C
HLMP-CE21-Z20DD	Cyan	505	23	Yes	12000	27000	D
HLMP-CE21-Z2CDD	Cyan	505	23	Yes	12000	27000	D
HLMP-CE21-Z2QDD	Cyan	505	23	Yes	12000	27000	D
HLMP-CE22-Y1CDD	Cyan	505	23	No	9300	21000	C
HLMP-CE22-Y1QDD	Cyan	505	23	No	9300	21000	C
HLMP-CE25-Y1CDD	Cyan	505	23	Yes	9300	21000	D
HLMP-CE25-Y1QDD	Cyan	505	23	Yes	9300	21000	D

# High Brightness LEDs

## High Brightness 5mm Round LED Lamp

Part Number	Color	Dominant Wavelength (nm)	Viewing Angle (°)	Standoff (Yes/NO)	Luminous Intensity (mcd) @ 20 mA		Package Drawing
					Min.	Max.	
<b>30° Viewing Angle</b>							
HLMP-EG3G-VX0DD	Red	626	30	No	4200	9300	A
HLMP-EG3H-VX0DD	Red	626	30	Yes	4200	9300	B
HLMP-EG3A-WX0DD	Red	626	30	No	5500	9300	A
HLMP-EG3B-WX0DD	Red	626	30	Yes	5500	9300	B
HLMP-EH3A-WX0DD	Red-Orange	615	30	No	5500	9300	A
HLMP-EH3B-WX0DD	Red-Orange	615	30	Yes	5500	9300	B
HLMP-EL3G-VX0DD	Amber	590	30	No	4200	9300	A
HLMP-EL3H-VX0DD	Amber	590	30	Yes	4200	9300	B
HLMP-EL3A-WXKDD	Amber	590	30	No	5500	9300	A
HLMP-EL3B-WXKDD	Amber	590	30	Yes	5500	9300	B
HLMP-CB3G-TV0DD	Blue	470	30	No	2500	5500	C
HLMP-CB3H-TV0DD	Blue	470	30	Yes	2500	5500	D
HLMP-CB3A-UV0DD	Blue	470	30	No	3200	5500	C
HLMP-CB3A-UVBDD	Blue	470	30	No	3200	5500	C
HLMP-CB3A-UVCDD	Blue	470	30	No	3200	5500	C
HLMP-CB3B-UV0DD	Blue	470	30	Yes	3200	5500	D
HLMP-CB3B-UVBDD	Blue	470	30	Yes	3200	5500	D
HLMP-CB3B-UVCDD	Blue	470	30	Yes	3200	5500	D
HLMP-CM3G-Y10DD	Green	525	30	No	9300	21000	C
HLMP-CM3H-Y10DD	Green	525	30	Yes	9300	21000	D
HLMP-CM3A-Z10DD	Green	525	30	No	12000	21000	C
HLMP-CM3A-Z1BDD	Green	525	30	No	12000	21000	C
HLMP-CM3A-Z1CDD	Green	525	30	No	12000	21000	C
HLMP-CM3B-Z10DD	Green	525	30	Yes	12000	21000	D
HLMP-CM3B-Z1BDD	Green	525	30	Yes	12000	21000	D
HLMP-CM3B-Z1CDD	Green	525	30	Yes	12000	21000	D
HLMP-CE34-XZCDD	Cyan	505	30	No	7200	16000	C
HLMP-CE34-XZQDD	Cyan	505	30	No	7200	16000	C
HLMP-CE35-XZCDD	Cyan	505	30	Yes	7200	16000	D
HLMP-CE35-XZQDD	Cyan	505	30	Yes	7200	16000	D
HLMP-CE32-Y10DD	Cyan	505	30	No	9300	21000	C
HLMP-CE32-Y1CDD	Cyan	505	30	No	9300	21000	C
HLMP-CE32-Y1QDD	Cyan	505	30	No	9300	21000	C
HLMP-CE33-Y10DD	Cyan	505	30	Yes	9300	21000	D
HLMP-CE33-Y1CDD	Cyan	505	30	Yes	9300	21000	D
HLMP-CE33-Y1QDD	Cyan	505	30	Yes	9300	21000	D

# High Brightness LEDs

## High Brightness Oval LED Lamp

Part Number	Color	Dominant Wavelength (nm)	Viewing Angle (°)	Standoff (Yes/NO)	Luminous Intensity (mcd) @ 20 mA		Lead Frame Orientation	Package Drawing	Remarks
					Min.	Max.			
<b>4 mm Standard Oval LED Lamp</b>									
<b>42° x 95° Viewing Angle</b>									
HLMP-LG3V-WX0DD	Red	621	42 x 95	Yes	1380	1990	Parallel	E	For full color sign application
HLMP-LM3V-24PDD	Green	525	42 x 95	Yes	3500	6050	Parallel	E	
HLMP-LB3V-TVPDD	Blue	468	42 x 95	Yes	800	1380	Parallel	E	
<b>45° x 90° Viewing Angle</b>									
HLMP-LG3Y-Y10DD	Red	621	45 x 90	Yes	1990	3500	Parallel	E	For full color sign application
HLMP-LM3Y-35PDD	Green	525	45 x 90	Yes	4200	7260	Parallel	E	
HLMP-LM3U-46PDD	Green	525	45 x 90	Yes	5040	8710	Parallel	E	
HLMP-LB3Y-VWPDD	Blue	468	45 x 90	Yes	1150	1660	Parallel	E	
<b>60° x 110° Viewing Angle</b>									
HLMP-LG3W-VW0DD	Red	621	50 x 105	Yes	1150	1660	Parallel	E	For full color sign application
HLMP-LM3W-12PDD	Green	525	60 x 110	Yes	2900	4200	Parallel	E	
HLMP-LB3W-STPDD	Blue	468	60 x 110	Yes	660	960	Parallel	E	
<b>50° x 100° Viewing Angle</b>									
HLMP-LH6S-XY0DD	Red Orange	615	50x100	Yes	1660	2400	Parallel	E	For mono color sign application
HLMP-LL6S-XYKDD	Amber	590	50x100	Yes	1660	2400	Parallel	E	
<b>4mm Standard Oval LED Lamp</b>									
<b>40° x 100° Viewing Angle</b>									
HLMP-LG71-VY0DD	Red	626	40x100	Yes	1150	2400	Parallel	E	For full color sign application
HLMP-LM71-Z30DD	Green	525	40x100	Yes	2400	5040	Parallel	E	
HLMP-LB71-SV0DD	Blue	470	40x100	Yes	660	1380	Parallel	E	
HLMP-LG75-XY0DD	Red	626	40x100	Yes	1660	2400	Parallel	E	
HLMP-LG73-XZ0DD	Red	626	40x100	Yes	1660	2900	Parallel	E	
HLMP-LM75-34CDD	Green	530	40x100	Yes	4200	6050	Parallel	E	
HLMP-LM73-35PDD	Green	530	40x100	Yes	4200	7260	Parallel	E	
HLMP-LB75-VWBDD	Blue	470	40x100	Yes	1150	1660	Parallel	E	
HLMP-LB72-UWPDD	Blue	470	40x100	Yes	960	1660	Parallel	E	
<b>4 mm Super Oval LED Lamp</b>									
<b>60° x 120° Viewing Angle</b>									
HLMP-SL20-MP0DD	Amber	590	60x120	Yes	520	1150	Perpendicular	F	For mono color sign application
HLMP-RL20-MP0DD	Amber	590	60x120	Yes	520	1150	Parallel	G	
<b>5 mm Standard Oval LED Lamps</b>									
<b>40° x 100° Viewing Angle</b>									
HLMP-HG64-WX0DD	Red	626	40x100	No	1380	1990	Parallel	H	For full color sign application
HLMP-HG65-WX0DD	Red	626	40x100	Yes	1380	1990	Parallel	I	
HLMP-HM64-34BDD	Green	525	40x100	No	4200	6050	Parallel	H	
HLMP-HM65-34BDD	Green	525	40x100	Yes	4200	6050	Parallel	I	
HLMP-HB64-STBDD	Blue	470	40x100	No	660	960	Parallel	H	



# High Brightness LEDs

## High Brightness Oval LED Lamp

Part Number	Color	Dominant Wavelength (nm)	Viewing Angle (°)	Standoff (Yes/NO)	Luminous Intensity (mcd) @ 20 mA		Lead Frame Orientation	Package Drawing	Remarks
					Min.	Max.			
HLMP-HB65-STBDD	Blue	470	40x100	Yes	660	960	Parallel	I	For full color sign application
HLMP-HG74-XY0DD	Red	626	40x100	No	1660	2400	Parallel	H	
HLMP-HG75-XY0DD	Red	626	40x100	Yes	1660	2400	Parallel	I	
HLMP-HM74-34CDD	Green	530	40x100	No	4200	6050	Parallel	H	
HLMP-HM75-34CDD	Green	530	40x100	Yes	4200	6050	Parallel	I	
HLMP-HB74-UVCDD	Blue	470	40x100	No	960	1380	Parallel	H	
HLMP-HB75-UVCDD	Blue	470	40x100	Yes	960	1380	Parallel	I	
HLMP-HH64-WX0DD	Red Orange	615	40x100	No	1380	1990	Parallel	H	For mono color sign application
HLMP-HH65-WX0DD	Red Orange	615	40x100	Yes	1380	1990	Parallel	I	
HLMP-HL64-XYKDD	Amber	590	40x100	No	1660	2400	Parallel	H	
HLMP-HL64-XYLDD	Amber	590	40x100	No	1660	2400	Parallel	H	
HLMP-HL65-XYKDD	Amber	590	40x100	Yes	1660	2400	Parallel	I	
HLMP-HL65-XYLDD	Amber	590	40x100	Yes	1660	2400	Parallel	I	
HLMP-HG70-VX0DD	Red	626	40x100	No	1150	1990	Parallel	H	
HLMP-HG71-VX0DD	Red	626	40x100	Yes	1150	1990	Parallel	I	
HLMP-HB70-TV8DD	Blue	470	40x100	No	800	1380	Parallel	H	For mono color sign application
HLMP-HB70-TV0DD	Blue	470	40x100	No	800	1380	Parallel	H	
HLMP-HB71-TV8DD	Blue	470	40x100	Yes	800	1380	Parallel	I	
HLMP-HB71-TV0DD	Blue	470	40x100	Yes	800	1380	Parallel	I	
HLMP-HM70-23BDD	Green	525	40x100	No	3500	5040	Parallel	H	
HLMP-HM70-23CDD	Green	525	40x100	No	3500	5040	Parallel	H	
HLMP-HM71-23BDD	Green	525	40x100	Yes	3500	5040	Parallel	I	
HLMP-HM71-23CDD	Green	525	40x100	Yes	3500	5040	Parallel	I	
HLMP-HG7U-XY0DD	Red	621	40x100	No	1660	2400	Parallel	H	For mono color sign application
HLMP-HG7U-XZ0DD	Red	621	40x100	No	1660	2900	Parallel	H	
HLMP-HG7Y-XY0DD	Red	621	40x100	Yes	1660	2400	Parallel	I	
HLMP-HG7Y-XZ0DD	Red	621	40x100	Yes	1660	2900	Parallel	I	
HLMP-HL7U-XYKDD	Amber	590	40x100	No	1660	2400	Parallel	H	
HLMP-HL7U-XYLDD	Amber	590	40x100	No	1660	2400	Parallel	H	
HLMP-HL7U-XZKDD	Amber	590	40x100	No	1660	2900	Parallel	H	
HLMP-HL7U-XZLDD	Amber	590	40x100	No	1660	2900	Parallel	H	
HLMP-HL7Y-XYKDD	Amber	590	40x100	Yes	1660	2400	Parallel	I	For mono color sign application
HLMP-HL7Y-XYLDD	Amber	590	40x100	Yes	1660	2400	Parallel	I	
HLMP-HL7Y-XZKDD	Amber	590	40x100	Yes	1660	2900	Parallel	I	
HLMP-HL7Y-XZLDD	Amber	590	40x100	Yes	1660	2900	Parallel	I	
HLMP-HM7U-34PDD	Green	525	40x100	No	4200	6050	Parallel	H	
HLMP-HM7U-35PDD	Green	525	40x100	No	4200	7260	Parallel	H	
HLMP-HM7Y-34PDD	Green	525	40x100	Yes	4200	6050	Parallel	I	
HLMP-HM7Y-35PDD	Green	525	40x100	Yes	4200	7260	Parallel	I	
HLMP-HB7U-VWPDD	Blue	468	40x100	No	1150	1660	Parallel	H	For mono color sign application
HLMP-HB7U-VXPDD	Blue	468	40x100	No	1150	1990	Parallel	H	

# High Brightness LEDs

## High Brightness Oval LED Lamp

Part Number	Color	Dominant Wavelength (nm)	Viewing Angle (°)	Standoff (Yes/NO)	Luminous Intensity (mcd) @ 20 mA		Lead Frame Orientation	Package Drawing	Remarks
					Min.	Max.			
<b>5 mm Standard Oval LED Lamps</b>									
<b>40° x 100° Viewing Angle</b>									
HLMP-HB7Y-VWPDD	Blue	468	40x100	Yes	1150	1660	Parallel	I	For mono color sign application
HLMP-HB7Y-VXPDD	Blue	468	40x100	Yes	1150	1990	Parallel	I	
<b>5 mm Mini Oval LED Lamps</b>									
<b>30° x 70° Viewing Angle</b>									
HLMP-AG64-Z10DD	Red	626	30x70	No	2400	3500	Parallel	J	For full color sign application
HLMP-AG65-Z10DD	Red	626	30x70	Yes	2400	3500	Parallel	K	
HLMP-AM64-460DD	Green	525	30x70	No	5040	8710	Parallel	J	
HLMP-AM65-45BDD	Green	525	30x70	Yes	5040	7260	Parallel	K	
HLMP-AG74-120DD	Red	626	30x70	No	2900	4200	Parallel	J	
HLMP-AG75-120DD	Red	626	30x70	Yes	2900	4200	Parallel	K	
HLMP-AM74-56CDD	Green	530	30x70	No	6050	8710	Parallel	J	
HLMP-AM75-56CDD	Green	530	30x70	Yes	6050	8710	Parallel	K	
HLMP-AB74-WXBDD	Blue	470	30x70	No	1380	1990	Parallel	J	
HLMP-AB75-WXBDD	Blue	470	30x70	Yes	1380	1990	Parallel	K	
HLMP-AH64-Z10DD	Red Orange	615	30x70	No	2400	3500	Parallel	J	For mono color sign application
HLMP-AH65-Z10DD	Red Orange	615	30x70	Yes	2400	3500	Parallel	K	
HLMP-AJ66-Z10DD	Orange	605	30x70	No	2400	3500	Parallel	J	
HLMP-AJ67-Z10DD	Orange	605	30x70	Yes	2400	3500	Parallel	K	
HLMP-AL64-23KDD	Amber	590	30x70	No	3500	5040	Parallel	J	
HLMP-AL65-23KDD	Amber	590	30x70	Yes	3500	5040	Parallel	K	
HLMP-AG70-Z20DD	Red	626	30x70	No	2400	4200	Parallel	J	
HLMP-AG71-Z20DD	Red	626	30x70	Yes	2400	4200	Parallel	K	
HLMP-AL70-13KDD	Amber	590	30x70	No	2900	5040	Parallel	J	
HLMP-AL70-13LDD	Amber	590	30x70	No	2900	5040	Parallel	J	
HLMP-AL71-13KDD	Amber	590	30x70	Yes	2900	5040	Parallel	K	
HLMP-AL71-13LDD	Amber	590	30x70	Yes	2900	5040	Parallel	K	
HLMP-AB70-TWBDD	Blue	470	30x70	No	800	1660	Parallel	J	
HLMP-AB70-TWCDD	Blue	470	30x70	No	800	1660	Parallel	J	
HLMP-AB71-TWBDD	Blue	470	30x70	Yes	800	1660	Parallel	K	
HLMP-AB71-TWCDD	Blue	470	30x70	Yes	800	1660	Parallel	K	
HLMP-AM70-35BDD	Green	525	30x70	No	4200	7260	Parallel	J	
HLMP-AM70-35CDD	Green	525	30x70	No	4200	7260	Parallel	J	
HLMP-AM71-35BDD	Green	525	30x70	Yes	4200	7260	Parallel	K	
HLMP-AM71-35CDD	Green	525	30x70	Yes	4200	7260	Parallel	K	

# High Brightness LEDs

## High Brightness Lamps

### High Brightness LED Lamps 1.3:1 Intensity Bin Limits (mcd at 20mA)

Bin ID	Min.	Max.
D	65	85
E	85	110
F	110	140
G	140	180
H	180	240
J	240	310
K	310	400
L	400	520
M	520	680
N	680	880
P	880	1150
Q	1150	1500
R	1500	1900
S	1900	2500
T	2500	3200
U	3200	4200
V	4200	5500
W	5500	7200
X	7200	9300
Y	9300	12000
Z	12000	16000
1	16000	21000
2	21000	27000
3	27000	35000
4	35000	45000
5	45000	59000
6	59000	76000

Tolerance for each bin limit is  $\pm 15\%$

### High Brightness LED Lamps 1.2:1 Intensity Bin Limits (mcd at 20mA)

Bin ID	Min.	Max.
P	380	460
Q	460	550
R	550	660
S	660	800
T	800	960
U	960	1150
V	1150	1380
W	1380	1660
X	1660	1990
Y	1990	2400
Z	2400	2900
1	2900	3500
2	3500	4200
3	4200	5040
4	5040	6050
5	6050	7260
6	7260	8710
7	8710	10460
8	10460	12560
9	12560	15100

Tolerance for each bin limit is  $\pm 15\%$

### Color Bin Structure

Bin ID	Wavelength (nm)		Remark
	Min.	Max.	
<b>Red</b>			
--	618.0	630.0	Type 1
--	620.0	630.0	Type 2
<b>Red Orange *1</b>			
--	612.0	619.0	Type 1
--	612.0	621.7	Type 2
<b>Orange *1</b>			
1	600.0	604.0	Type 1
2	604.0	608.0	
3	608.0	612.0	
2	599.5	604.5	Type 2
4	604.5	610.5	
<b>Amber</b>			
1	584.5	587.0	
2	587.0	589.5	
4	589.5	592.0	
6	592.0	594.5	
<b>Green *1</b>			
1	520.0	524.0	Type 1
2	524.0	528.0	Type 1
3	528.0	532.0	Type 1
4	532.0	536.0	Type 1
5	536.0	540.0	Type 1
1	519.0	523.0	Type 2
2	523.0	527.0	Type 2
3	527.0	531.0	Type 2
4	531.0	535.0	Type 2
5	535.0	539.0	Type 2
<b>Blue</b>			
1	460.0	464.0	
2	464.0	468.0	
3	468.0	472.0	
4	472.0	476.0	
5	476.0	480.0	

**Note 1:** There are 2 types of color bin limits. Please refer to individual datasheet for details.

Tolerance for each bin limit is  $\pm 0.5\text{nm}$

# High Brightness LEDs

## High Brightness Lamps Package Drawing

### 5 mm Round LED Lamp

**A: Non-standoff**

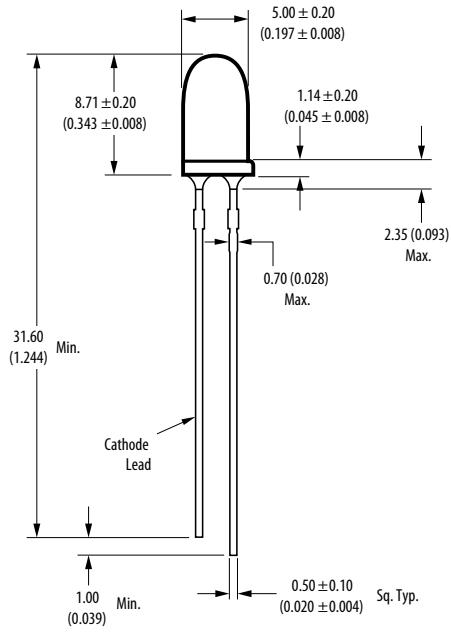

**B: Standoff**

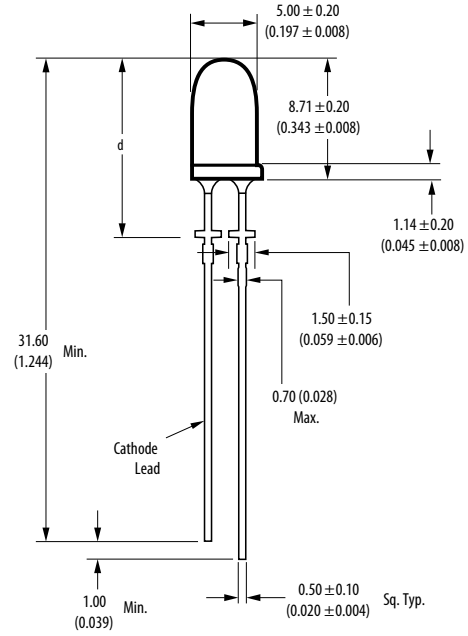

Note:  
Please refer to individual datasheet for dimension D.

### 5 mm Round LED Lamp

**C: Non-standoff**

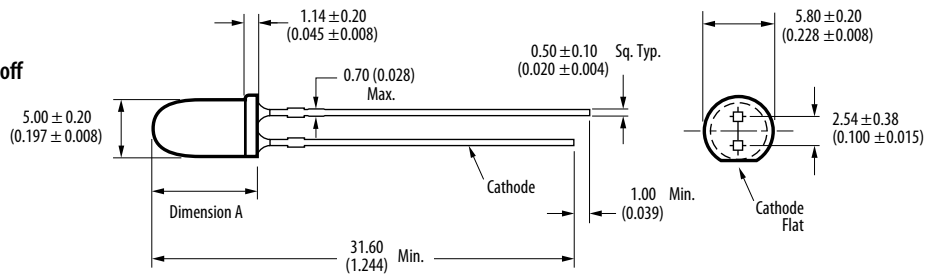

**D: Standoff**

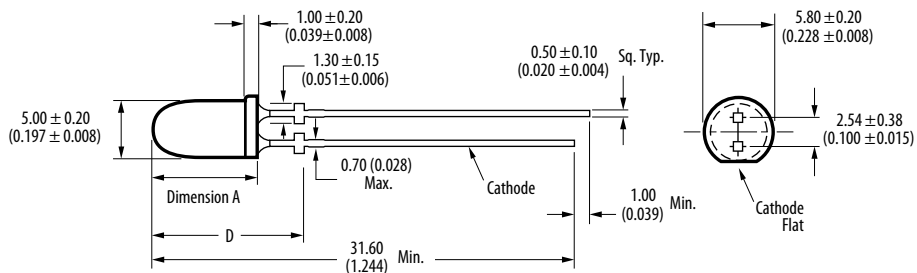

Note:  
Please refer to individual datasheet for dimension A and D.

# High Brightness LEDs

## 4 mm Standard Oval LED Lamp

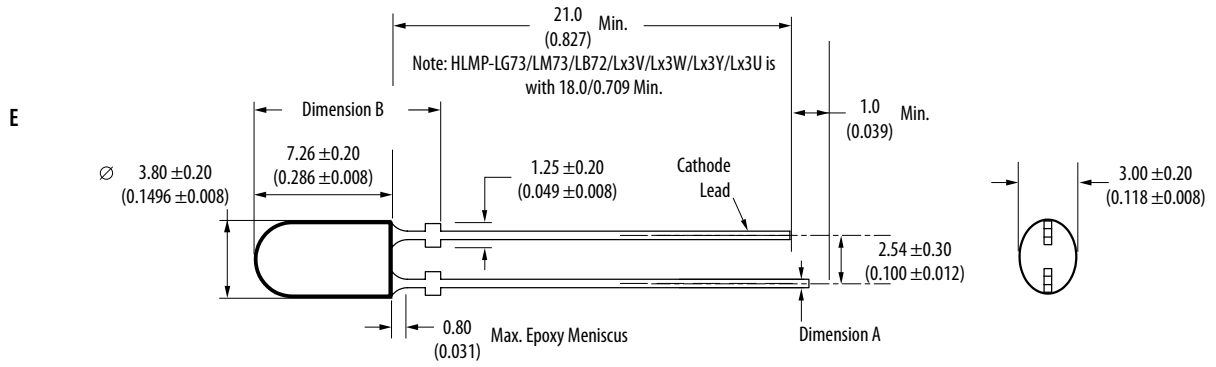

Note:  
Please refer to individual datasheet for dimension A and dimension B.

## 4 mm Super Oval LED Lamp 60° x 120° Viewing Angle

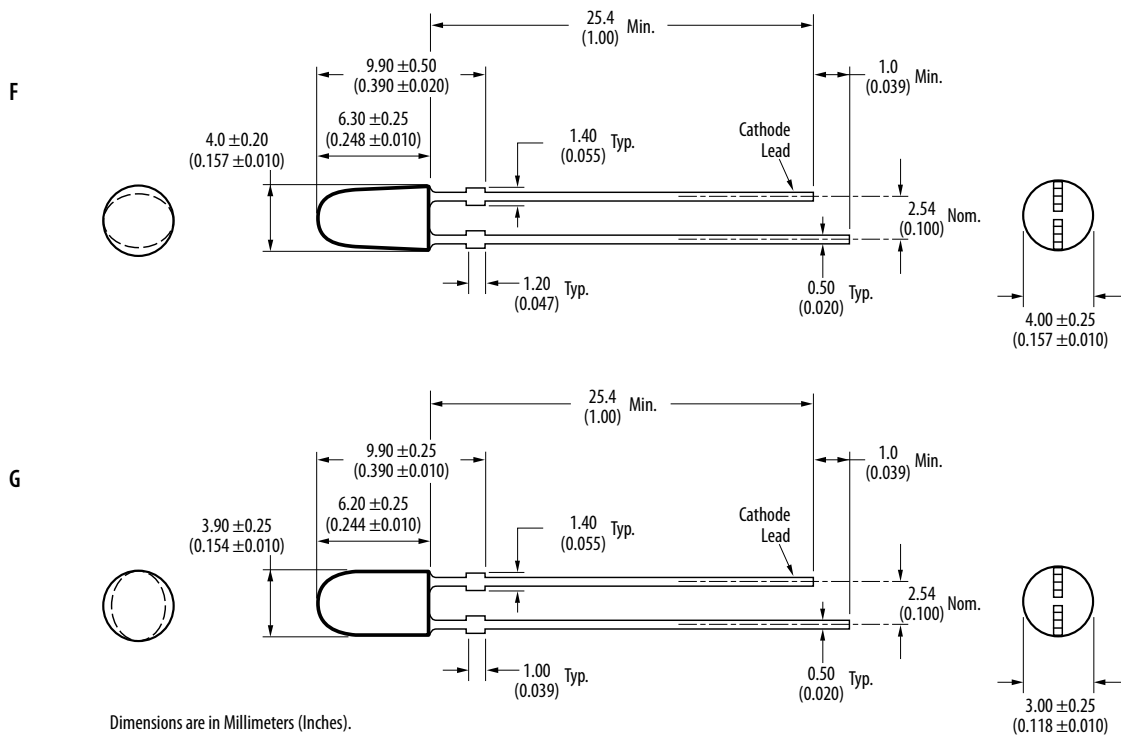

# High Brightness LEDs

## 5 mm Standard Oval LED Lamp 40° x 100° Viewing Angle

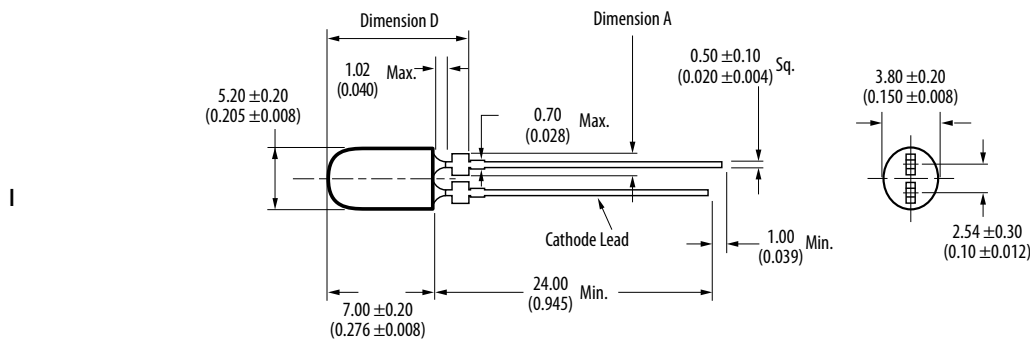
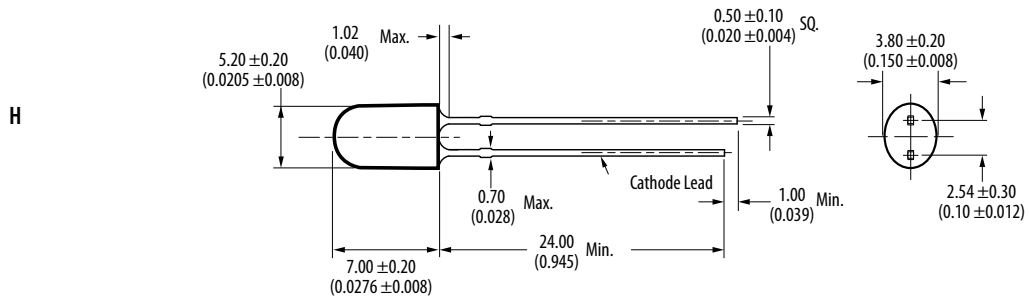

## 5mm Mini Oval LED Lamp 30° x 70° Viewing Angle

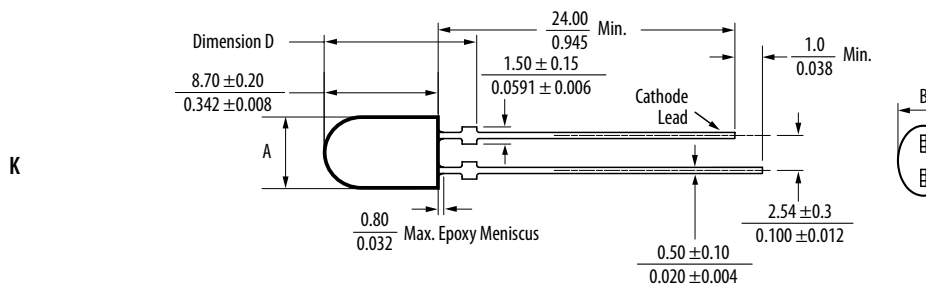
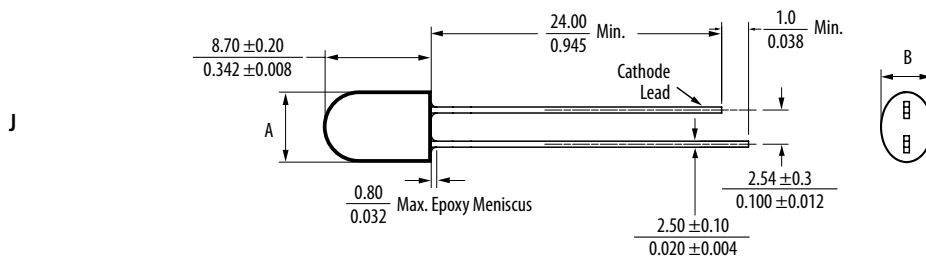

Note:  
For all package drawings above, the dimension are in millimeters (inches).  
Please refer to individual datasheet for dimension A, B and D.

# High Brightness LEDs



## High Brightness SMT Lamps

### Description

Avago Technologies offers industry's first Surface Mount High Brightness Round and Oval LED lamps for Electronic Sign Application. These SMT lamps are compatible with industrial reflow soldering processes and made with advanced optical grade epoxy to provide superior performance in outdoor application.

### Features and Benefits

- Compact form factor with well defined spatial radiation pattern
- High Brightness AlInGaP and InGaN material available in Red, Amber, Green and Blue
- Moisture sensitivity level (MSL) 2A
- Compatible with industrial reflow soldering process
- Lens features: Tinted for SMT Round
  - Tinted and diffused for SMT Oval

### Typical Applications

- Electronic Signs and signals
  - Traffic Signal
  - Variable Message Signs
  - Full Color Signs
  - Mono Color Signs

### High Brightness SMT Round and Oval Lamps

Part Number	Color	Typ. Dominant Wavelength (nm)	Typ. Viewing Angle (°)	Lens Tinted	Lens Diffused	Luminous Intensity (mcd) @ 20 mA		Package Drawing
						Min.	Max.	
<b>SMT Round Lamps</b>								
30° Viewing Angle								
ALMD-EG3D-VX002	Red	626	30	Yes	No	4200	9300	A
ALMD-EL3D-VX002	Amber	590	30	Yes	No	4200	9300	
ALMD-CM3D-XZ002	Green	525	30	Yes	No	7200	16000	
ALMD-CB3D-SU002	Blue	470	30	Yes	No	1900	5500	
ALMD-EG3E-VX002	Red	626	30	Yes	No	4200	9300	C
ALMD-EL3E-VX002	Amber	590	30	Yes	No	4200	9300	
ALMD-CM3E-Y1002	Green	525	30	Yes	No	9300	21000	
ALMD-CB3E-SU002	Blue	470	30	Yes	No	1900	4200	
ALMD-CM3F-Y1002	Green	525	30	Yes	No	9300	21000	
ALMD-CB3F-TV002	Blue	470	30	Yes	No	2500	5500	

# High Brightness LEDs

## High Brightness SMT Round and Oval Lamps

Part Number	Color	Typ. Dominant Wavelength (nm)	Typ. Viewing Angle (°)	Lens Tinted	Lens Diffused	Luminous Intensity (mcd) @ 20 mA		Package Drawing
						Min.	Max.	
<b>SMT Oval Lamps</b>								
40 × 100° Viewing Angle								
ALMD-LG36-WZ002	Red	626	40 x 100	Yes	Yes	1380	2900	B
ALMD-LL36-WZ002	Amber	590	40 x 100	Yes	Yes	1380	2900	
ALMD-LM36-14002	Green	525	40 x 100	Yes	Yes	2900	6050	
ALMD-LB36-SV002	Blue	470	40 x 100	Yes	Yes	660	1380	
	Red	626	40 x 100	Yes	Yes	1660	2900	D
ALMD-LL37-XZ002	Amber	590	40 x 100	Yes	Yes	1660	2900	
ALMD-LM37-24002	Green	525	40 x 100	Yes	Yes	3500	6050	
ALMD-LB37-SU002	Blue	470	40 x 100	Yes	Yes	660	1150	
ALMD-LM38-24002	Green	525	40 x 100	Yes	Yes	3500	6050	
ALMD-LB38-TV002	Blue	470	40 x 100	Yes	Yes	800	1380	

## High Brightness SMT Round Lamps

### 1.3:1 Intensity Bin Limits (mcd at 20mA)

Bin ID	Min.	Max.
R	1500	1900
S	1900	2500
T	2500	3200
U	3200	4200
V	4200	5500
W	5500	7200
X	7200	9300
Y	9300	12000
Z	12000	16000

Tolerance of each bin limit is ± 15%

## High Brightness SMT Oval Lamps

### 1.2:1 Intensity Bin Limits (mcd at 20mA)

Bin ID	Min.	Max.
R	550	660
S	660	800
T	800	960
U	960	1150
V	1150	1380
W	1380	1660
X	1660	1990
Y	1990	2400
Z	2400	2900
1	2900	3500
2	3500	4200
3	4200	5040
4	5040	6050

Tolerance of each bin limit is ± 15%

## Color Bin Structure

Bin ID	Wavelength (nm)	
	Min.	Max.
Red	618.0	630.0

Tolerance for each bin limits is ± 0.05nm

Bin ID	Wavelength (nm)	
	Min.	Max.
Amber		
1	584.5	587.0
2	587.0	589.5
4	589.5	592.0
6	592.5	594.0

Tolerance for each bin limits is ± 0.05nm

Bin ID	Wavelength (nm)	
	Min.	Max.
Green		
1	519.0	523.0
2	523.0	527.0
3	527.0	531.0
4	531.0	535.0
5	535.0	539.0

Tolerance for each bin limits is ± 0.05nm

Bin ID	Wavelength (nm)	
	Min.	Max.
Blue		
1	460.0	464.0
2	464.0	468.0
3	468.0	472.0
4	472.0	476.0
5	476.0	480.0

Tolerance for each bin limits is ± 0.05nm



# High Brightness LEDs

## High Brightness SMT Lamps Package Drawing

### Package Drawing A

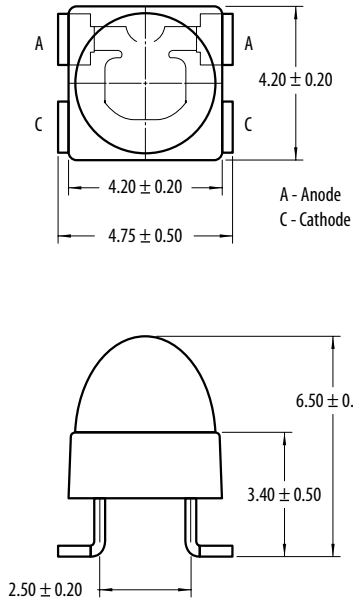

### Package Drawing B

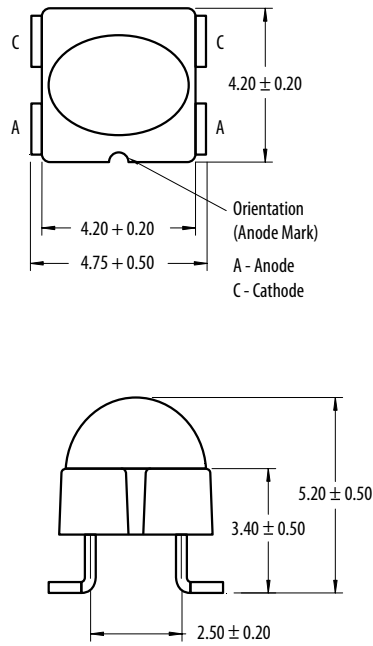

### Package Drawing C

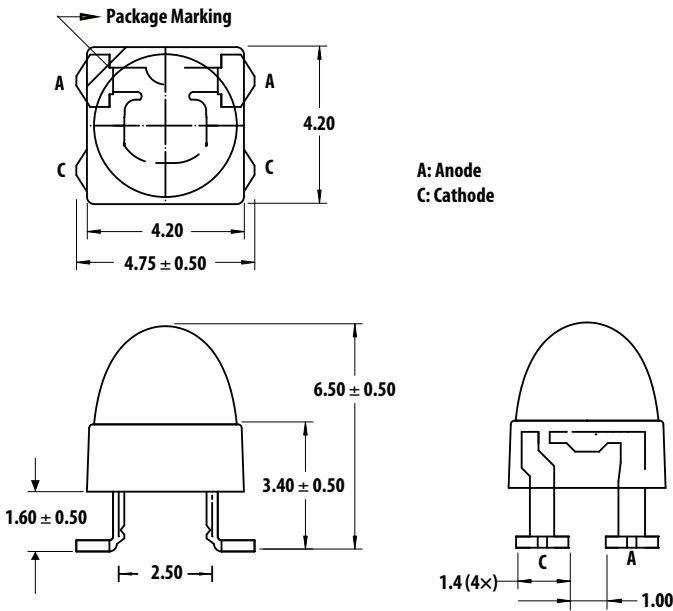

### Package Drawing D

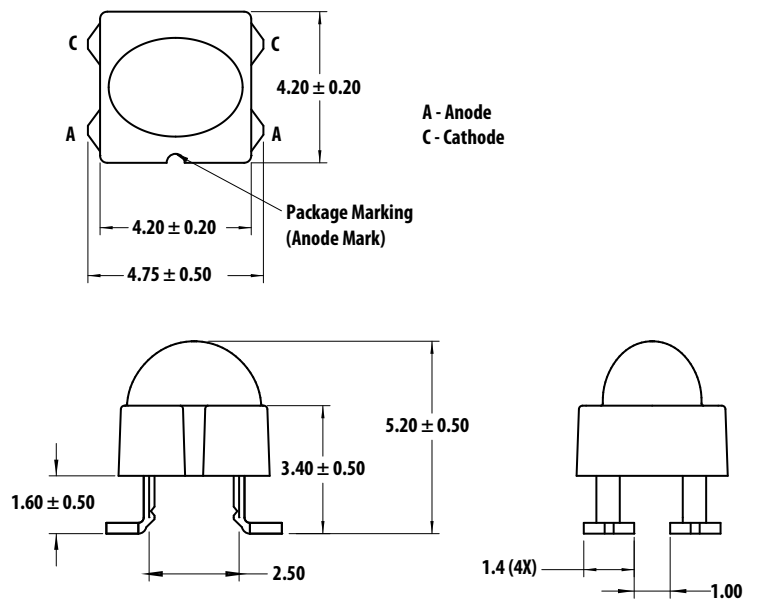

#### Notes:

1. All dimensions in millimeters (inches).
2. Tolerance is  $\pm 0.20\text{mm}$  unless other specified.

# High Brightness LEDs



## Surface Mount PLCC LEDs

### Description

This surface-mount LED comes in PLCC standard package dimension. It has a substrate made up of a molded plastic reflector sitting on top of a bent lead frame. The die is attached within the reflector cavity and the cavity is encapsulated by an Avago Technologies proprietary epoxy or silicone material.

The PLCC SMT LED products with a viewing angle of 120° is ideal for instruments/switch/icon backlighting. With additional lens in 30° and 50° variants, these products are especially fitting to applications for traffic lights, CHMSL and displays. Its external reflector makes easy coupling with light pipe/light guide for an even-larger area backlighting. The package design coupled with careful selection of component materials allow these products to perform with high reliability in a larger temperature range -40°C to 100°C. The high reliability feature is crucial to Automotive Interior and Indoor ESS.

The surface-mount LED is designed to be compatible with industrial reflow soldering process.

### Features and Benefits

- Industry Standard PLCC SMT package
  - No change in existing board layout, drop-in replacement for the existing PLCC SMT LEDs
- High brightness using AlInGaP and InGaN dice technologies
- Available in various colors
  - Red, Red Orange, Orange, Amber, Yellow Green, Emerald Green, Green, Blue and White
  - Bi-colors in various combinations
  - Tri-colors in Red, Green and Blue
- Available in viewing angle of 30°, 50° and 120°
  - Well-suited for backlighting applications
- High volume, high reliability
  - Cost-effective solution
- Black surface and black body options to enhance contrast for display application

### Target Markets and Applications

- Interior automotive
  - Instrument panel backlighting
  - Central console backlighting
  - Cabin backlighting
- Exterior automotive
  - Turn signals
  - Side repeater lamps
  - CHMSLs (center high-mounted stop light)
  - Rear combination lamps
  - Puddle lights
- Electronic Signs and Signals
  - Interior full color sign
  - Variable message sign
- Office Automation, Electrical Appliances, Industrial Equipment
  - Front panel backlighting
  - Push button backlighting
  - Display backlighting

### PLCC Surface Mount LEDs PLCC-2 White

Part Number	Color	Chromaticity		Viewing Angle	Intensity		Vf typ.	Test Current
		x	y		Min.	Max.		
HSMW-A100-V40J1	InGaN White	0.31	0.31	120	715	1800	3.4	20

**Notes:**

1. The luminous intensity  $I_v$  is measured at the mechanical axis of the lamp package. The actual peak of the spatial radiation pattern may not be aligned with this axis.
2. The chromaticity coordinates are derived from the CIE 1931 Chromaticity Diagram and represents the perceived color of the device.
3.  $\theta_{1/2}$  is the off-axis angle where the luminous intensity is 1/2 the peak intensity.

# High Brightness LEDs

## PLCC Surface Mount LEDs PLCC-2

Part Number	Color	Dominant Wavelength	Viewing Angle	Intensity		Vf typ.	Test Current
HSMS-A100-J00J1	Red	626	120	4.5	–	2.2	20
HSMH-A100-L00J1	Red	637	120	11.2	–	1.9	20
HSMC-A100-Q00J1	Red	626	120	71.5	–	1.9	20
HSMC-A101-S40J1	Red	626	120	180	450	1.9	20
ASMT-URB4-PU802	Red	626	120	560	1400	1.9	20
HSMJ-A100-T40J1	Red Orange	615	120	285	715	1.9	20
HSMJ-A101-S00J1	Red Orange	615	120	180	–	1.9	20
ASMT-URB4-PU802	Red Orange	615	120	560	1400	1.9	20
HSMD-A100-J00J1	Orange	602	120	4.4	–	2.2	20
HSML-A100-Q00J1	Orange	605	120	71.5	–	1.9	20
HSMY-A100-J00J1	Amber	585	120	4.5	–	2.2	20
HSMA-A101-S70J1	Amber	590	120	224	450	1.9	20
ASMT-UAB4-PU802	Amber	590	120	560	1400	1.9	20
HSMG-A100-J02J1	Yellow Green	569	120	4.5	–	2.2	20
HSME-A100-M02J1	Yellow Green	569	120	18	–	1.9	20
HSMG-A100-H01J1	Emerald Green	560	120	2.8	–	2.2	20
HSME-A100-L01J1	Emerald Green	560	120	11.2	–	1.9	20
HSMM-A100-U4P1	Green	525	120	450	1125	3.4	20
ASMT-UGB5-NV702	Green	525	120	900	1800	3.4	20
HSMN-A100-S4Y1	Blue	470	120	180	450	3.4	20
ASMT-UBB5-NS8Q2	Blue	470	120	224	560	3.4	20

Notes:

1. The luminous intensity  $I_v$  is measured at the mechanical axis of the lamp package. The actual peak of the spatial radiation pattern may not be aligned with this axis.
2. The dominant wavelength,  $\lambda_D$ , is derived from the CIE Chromaticity Diagram and represents the color of the device.
3.  $\theta_{1/2}$  is the off-axis angle where the luminous intensity is 1/2 the peak intensity.

## PLCC-2 White (ASMT-UWB1)

Part Number	Color	CCT (K)	CRI	Viewing Angle	Luminous Intensity (mcd)			Test Current (mA)
				$2\theta_{1/2}$ (°)	Min	Typ	Max	
ASMT-UWB1-NX702	InGaN White	4500 ~ 8000	70	120	2240	2300	4500	20
ASMT-UWB1-NX712	InGaN White	2700 ~ 4000	70	120	2240	2300	4500	20
ASMT-UWB1-NX7A2	InGaN White	8000	70	120	2240	2300	4500	20
ASMT-UWB1-NX7B2	InGaN White	6500	70	120	2240	2300	4500	20
ASMT-UWB1-NX7C2	InGaN White	5700	70	120	2240	2300	4500	20
ASMT-UWB1-NX7D2	InGaN White	5000	70	120	2240	2300	4500	20
ASMT-UWB1-NX7E2	InGaN White	4500	70	120	2240	2300	4500	20
ASMT-UWB1-NX7F2	InGaN White	4000	70	120	2240	2300	4500	20
ASMT-UWB1-NX3G2	InGaN White	3500	70	120	1800	2300	3550	20
ASMT-UWB1-NX3H2	InGaN White	3000	70	120	1800	2300	3550	20
ASMT-UWB1-NX3J2	InGaN White	2700	70	120	1800	2300	3550	20
ASMT-UWB2-NX302	InGaN White	4500 ~ 8000	80	120	1800	2300	3550	20
ASMT-UWB2-NX3A2	InGaN White	8000	80	120	1800	2300	3550	20
ASMT-UWB2-NX3B2	InGaN White	6500	80	120	1800	2300	3550	20
ASMT-UWB2-NX3C2	InGaN White	5700	80	120	1800	2300	3550	20
ASMT-UWB2-NX3D2	InGaN White	5000	80	120	1800	2300	3550	20
ASMT-UWB2-NX3E2	InGaN White	4500	80	120	1800	2300	3550	20
ASMT-UWB2-NW7F2	InGaN White	4000	80	120	1400	1500	2850	20
ASMT-UWB2-NW7G2	InGaN White	3500	80	120	1400	1500	2850	20
ASMT-UWB2-NW7H2	InGaN White	3000	80	120	1400	1500	2850	20
ASMT-UWB2-NW7J2	InGaN White	2700	80	120	1400	1500	2850	20

Tolerance  $\pm 12\%$

# High Brightness LEDs

## PLCC Surface Mount LEDs

### Power PLCC-4

Part Number	Color	Typ. Dominant Wavelength $\lambda_D^{(1)}$ (nm)	Viewing Angle $2\theta_{1/2}^{(2)}$ (°)	Min. $I_V$ (mcd)	Max. $I_V$ (mcd)	Typ. $V_F$ (V)	Test Current (mA)
HSMC-A401-U80M1	Red	626	120	560	1400	2.2	50
ASMT-SRB4-PW505	Red	626	120	1125	3550	2.2	50
HSMA-A401-U80M1	Amber	590	120	560	1400	2.2	50
HSMA-A401-V30M1	Amber	590	120	715	1400	2.2	50
ASMT-SAB4-PW505	Amber	590	120	1125	3550	2.2	50
HSML-A401-U40M1	Orange	605	120	450	1125	2.2	50
HSMJ-A401-U40M1	Red Orange	615	120	450	1125	2.2	50
ASMT-SHB4-PW905	Red Orange	615	120	1125	3550	2.2	50
HSME-A401-P4PM1	Emerald Green	567	120	45	112.5	2.2	50
HSMM-A400-V8QM2	Green	525	120	900	2240	3.8	30
HSMM-A400-V8YM2	Green	525	120	1400	2240	3.8	30
ASMT-SGB5-NW703	Green	525	120	224	2850	3.2	30
HSMN-A400-S8PM	Blue	470	120	224	560	3.8	30
HSMN-A400-S8QM2	Blue	470	120	224	560	3.8	30
ASMT-SBB5-NT703	Blue	470	120	355	715	3.2	30

#### Notes:

1. The dominant wavelength,  $\lambda_D$ , is derived from the CIE Chromaticity Diagram and represents the color of the device.
2.  $\theta_{1/2}$  is the off-axis angle where the luminous intensity is 1/2 the peak intensity.
3. The luminous intensity,  $I_V$ , is measured at the mechanical axis of the lamp package. The actual peak of the spatial radiation pattern may not be aligned with this axis.

### Power PLCC-4 White

Part Number	Color	Chromaticity		Viewing Angle	Intensity			Vf typ.	Test Current
		x	y		Min.	Typ.	Max.		
HSMW-A400-U00M2	InGaN White	0.31	0.31	120	450	700	-	3.8	30
ASMT-SWBM-NV803	InGaN White	0.318	0.318	120	900	1100	2240	3.5	30

#### Notes:

1. The luminous intensity  $I_V$ , is measured at the mechanical axis of the lamp package. The actual peak of the spatial radiation pattern may not be aligned with this axis.
2.  $I_V$  Tolerance =  $\pm 12\%$ .
3. The chromaticity coordinates are derived from the CIE 1931 Chromaticity Diagram and represent the perceived color of the device.
4.  $\theta_{1/2}$  is the off-axis angle where the luminous intensity is  $1/2$  the peak intensity.

### Power PLCC-4 with Lens

Part Number	Color	Dominant Wavelength $\lambda_D^{(1)}$ (nm)	Viewing Angle $2\theta_{1/2}$ (°)	Min. $I_V$ (mcd)	Max. $I_V$ (mcd)	Typ. $V_F$ (V)	Test Current (mA)
HSMC-A431-Y80M1	AllInGaP Red	626	30	3550	9000	2.2	50
HSMC-A431-X90M1	AllInGaP Red	626	30	2240	7150	2.2	50
HSMC-A461-V00M1	AllInGaP Red	626	50	715	-	2.2	50
HSMJ-A430-W50M1	AllInGaP Red Orange	615	30	1125	3550	2.2	50
HSMJ-A431-X90M1	AllInGaP Red Orange	615	30	2240	7150	2.2	50
HSMJ-A461-W40M1	AllInGaP Red Orange	615	50	1125	2850	2.2	50
HSML-A431-X90M1	AllInGaP Orange	605	30	2240	7150	2.2	50
HSML-A461-W40M1	AllInGaP Orange	605	50	1125	2850	2.2	50
HSMA-A431-Y00M1	AllInGaP Amber	590	30	2850	-	2.2	50
HSMA-A431-Z50M1	AllInGaP Amber	590	30	4500	14000	2.2	50
HSMA-A461-X83M1	AllInGaP Amber	590	50	2240	5600	2.2	50
HSMM-A430-Y7YM2	InGaN Green	525	30	3550	7150	3.9	30
HSMN-A430-V7YM2	InGaN Blue	470	30	900	1800	3.9	30

#### Notes:

1. The luminous intensity,  $I_V$ , is measured at the mechanical axis of the lamp package. The actual peak of the spatial radiation pattern may not be aligned with this axis.
2.  $I_V$  tolerance  $\pm 12\%$ .
3. The dominant wavelength,  $\lambda_D$ , is derived from the CIE Chromaticity Diagram and represents the color of the device.
4.  $\theta_{1/2}$  is the off-axis angle where the luminous intensity is  $1/2$  the peak intensity.

# High Brightness LEDs

## PLCC Surface Mount LEDs

### Bicolor PLCC-4

Part Number	Color	Min. I <sub>v</sub> @ 20mA		Typ. I <sub>v</sub> (mcd) @ 20mA
		Bin ID	mcd	
HSMF-A201-A00J1	GaP Red	K2	8	16
	GaP Yellow Green	L1	10	20
HSMF-A202-A00J1	GaP Red	K2	8	16
	GaP Yellow	K1	6.3	12
HSMF-A203-A00J1	GaP Red	K2	8	16
	GaP Emerald Green	J1	4	8
HSMF-A204-A00J1	GaP Orange	K2	8	16
	GaP Yellow Green	L1	10	20
HSMF-A205-A00J1	GaP Orange	K2	8	16
	GaP Emerald Green	J1	4	8
HSMF-A206-A00J1	GaP Yellow	K2	8	16
	GaP Yellow Green	L1	10	20
HSMF-A211-A00J1	AlGaAs Red	L2	12.5	25
	GaP Yellow Green	L1	10	20
HSMF-A212-A00J1	AlGaAs Red	L2	12.5	25
	GaP Yellow	K1	6.3	12
HSMF-A222-A00J1	AllnGaP Red	P1	40	80
	AllnGaP Amber	P1	40	80
HSMF-A226-A00J1	AllnGaP Amber	P2	50	100
	AllnGaP Yellow Green	M2	20	60

### Super 0.25W Power PLCC-4

Part Number	Color	CCT (K)	Viewing Angle (°)	Min Flux (lm)	Max Flux (lm)	Forward Voltage (V <sub>f</sub> ) I <sub>f</sub> =80mA	Test Current (mA)
ASMT-UWBG-NAC08	Cool White	4000 ~ 8000	120	18.1	35.2	3.4	80
ASMT-UWBG-NACA8	Cool White	8000	120	18.1	35.2	3.4	80
ASMT-UWBG-NACB8	Cool White	6500	120	18.1	35.2	3.4	80
ASMT-UWBG-NACC8	Cool White	5700	120	18.1	35.2	3.4	80
ASMT-UWBG-NACD8	Cool White	5000	120	18.1	35.2	3.4	80
ASMT-UWBG-NACE8	Cool White	4500	120	18.1	35.2	3.4	80
ASMT-UWBG-NACF8	Cool White	4000	120	18.1	35.2	3.4	80
ASMT-UWBH-NBD08	Cool White	4000 ~ 8000	120	23.5	39.8	3.4	80
ASMT-UWBH-NBDA8	Cool White	8000	120	23.5	39.8	3.4	80
ASMT-UWBH-NBDB8	Cool White	6500	120	23.5	39.8	3.4	80
ASMT-UWBH-NBDC8	Cool White	5700	120	23.5	39.8	3.4	80
ASMT-UWBH-NBDD8	Cool White	5000	120	23.5	39.8	3.4	80
ASMT-UWBH-NBDE8	Cool White	4500	120	23.5	39.8	3.4	80
ASMT-UWBH-NBDF8	Cool White	4000	120	23.5	39.8	3.4	80
ASMT-UYBG-NAC18	Warm White	2700 ~ 3500	120	18.1	35.2	3.4	80
ASMT-UYBG-NACG8	Warm White	3500	120	18.1	35.2	3.4	80
ASMT-UYBG-NACH8	Warm White	3000	120	18.1	35.2	3.4	80
ASMT-UYBG-NACJ8	Warm White	2700	120	18.1	35.2	3.4	80

# High Brightness LEDs

## Super 0.25W Power PLCC-4

Part Number	Color	CCT (K)	Viewing Angle (°)	Min Flux (lm)	Max Flux (lm)	Forward Voltage (Vf) If=80mA	Test Current (mA)
ASMT-UYBH-NAC18	Warm White	2700 ~ 3500	120	18.1	35.2	3.2	80
ASMT-UYBH-NACG8	Warm White	3500	120	18.1	35.2	3.2	80
ASMT-UYBH-NACH8	Warm White	3000	120	18.1	35.2	3.2	80
ASMT-UYBH-NACJ8	Warm White	2700	120	18.1	35.2	3.2	80

Tolerance ±12%

## Super 0.5W Power PLCC-4

Part Number	Color	Dominant Wavelength $\lambda_D$ <sup>[1]</sup> (nm)	Viewing Angle $2\theta_{1/2}$ <sup>[2]</sup> (°)	Min. Flux (lm)	Max. Flux (lm)	Forward Voltage (Vf) If=150mA	Test Current (mA)
ASMT-QABD-AEFOE	Amber	593.1	120	11.5	25.5	2.5	150
ASMT-QHBD-AFHOE	Red Orange	616.1	120	11.5	25.5	2.5	150
ASMT-QRBD-AEFOE	Red	621.1	120	11.5	25.5	2.5	150
ASMT-QBB3-NBDOE	Blue	460	120	5.5	11.5	3.5	150
ASMT-QGBE-NFHOE	Green	522	120	15.0	33.0	3.6	150

**Notes:**

1. The dominant wavelength,  $\lambda_D$ , is derived from the CIE Chromaticity diagram and represents the color of the device.
2.  $\theta_{1/2}$  is the off-axis angle where the luminous intensity is 1/2 the peak intensity.
3.  $\Phi_V$  is the total luminous flux output as measured with an integrating sphere at mono pulse conditions.
4. Tolerance = ±12%.

## PLCC Surface Mount LEDs

### Super 0.5W White Power PLCC-4

Part Number	Color	CCT (K)	Viewing Angle $2\theta_{1/2}$ <sup>[2]</sup> (°)	Min. Flux (lm)	Max. Flux (lm)	Forward Voltage (Vf) If=150mA	Test Current (mA)
ASMT-QWBF-NKLOE	Cool White	4500-1000	120	43	73	3.3	150
ASMT-QYBF-NJKOE	Warm White	2500-4800	120	33	56	3.3	150

**Notes:**

1.  $\theta_{1/2}$  is the off-axis angle where the luminous intensity is 1/2 the peak intensity.
2.  $\Phi_V$  is the total luminous flux output as measured with an integrating sphere at mono pulse conditions.
3. Tolerance = ±12%.

# High Brightness LEDs

## TheiaLED Super 0.5W White Power PLCC-4

Part number	Color	CCT (K)	Viewing Angle (°)	Min Flux (lm)	Max Flux (lm)	Forward Voltage (V <sub>F</sub> ) I <sub>F</sub> =150mA	Test Current (mA)	CRI
ASMT-QWBG-NFH0E	Cool White	4000 ~ 8000	120	45.7	62	3.2	150	85
ASMT-QWBG-NFHAE	Cool White	8000	120	45.7	62	3.2	150	85
ASMT-QWBG-NFHBE	Cool White	6500	120	45.7	62	3.2	150	85
ASMT-QWBG-NFHCE	Cool White	5700	120	45.7	62	3.2	150	85
ASMT-QWBG-NFHDE	Cool White	5000	120	45.7	62	3.2	150	85
ASMT-QWBG-NFHEE	Cool White	4500	120	45.7	62	3.2	150	85
ASMT-QWBG-NFHFE	Cool White	4000	120	45.7	62	3.2	150	85
ASMT-QWBH-NGJ0E	Cool White	4000 ~ 8000	120	51.7	67.2	3.2	150	75
ASMT-QWBH-NGJAE	Cool White	8000	120	51.7	67.2	3.2	150	75
ASMT-QWBH-NGJBE	Cool White	6500	120	51.7	67.2	3.2	150	75
ASMT-QWBH-NGJCE	Cool White	5700	120	51.7	67.2	3.2	150	75
ASMT-QWBH-NGJDE	Cool White	5000	120	51.7	67.2	3.2	150	75
ASMT-QWBH-NGJEE	Cool White	4500	120	51.7	67.2	3.2	150	75
ASMT-QWBH-NGJFE	Cool White	4000	120	51.7	67.2	3.2	150	75
ASMT-QYBG-NEG1E	Warm White	2700 ~ 3500	120	39.8	56.8	3.2	150	85
ASMT-QYBG-NEGGE	Warm White	3500	120	39.8	56.8	3.2	150	85
ASMT-QYBG-NEGHE	Warm White	3000	120	39.8	56.8	3.2	150	85
ASMT-QYBG-NEGJE	Warm White	2700	120	39.8	56.8	3.2	150	85
ASMT-QYBH-NEG1E	Warm White	2700 ~ 3500	120	39.8	56.8	3.2	150	75
ASMT-QYBH-NEGGE	Warm White	3500	120	39.8	56.8	3.2	150	75
ASMT-QYBH-NEGHE	Warm White	3000	120	39.8	56.8	3.2	150	75
ASMT-QYBH-NEGJE	Warm White	2700	120	39.8	56.8	3.2	150	75

Tolerance ±12%

# High Brightness LEDs

## High Brightness Tricolor PLCC4 & PLCC6

Part Number	Color	Package	Package Dimension	Viewing Angle (°)	Dominant Wavelength (nm)	Min Intensity (mcd) @ 20mA		Typ IV @ 20mA	Features
						Bin	mcd		
ASMB-BTE1-0B332	Red	PLCC-4	3.5x 2.8x 1.9	110	622	U1	450	630	Black Body White Reflector
	Green				529	W1	1125	1500	
	Blue				469	T1	285	350	
ASMB-MTB0-0A302	Red	PLCC-4	3.5x 2.8x 1.9	115	625	U1	450	540	Black Surface
	Green				530	W1	1125	1600	
	Blue				470	T1	285	350	
ASMB-MTB1-0A302	Red	PLCC-4	3.5x 2.8x 1.9	115	625	U1	450	540	Black Surface
	Green				530	W1	1125	1600	
	Blue				470	T1	285	350	
ASMB-MTC1-0A3A2	Red	PLCC-4	3.4 x 2.8 x 1.8	105	625	S1	180	280	Black Body
	Green				528	U2	560	850	
	Blue				470	R1	112.5	170	
ASMB-TTB0-0A3A2	Red	PLCC-6	3.5 x 3.5 x 2.8	115	621	U2	560	790	Black Surface
	Green				530	X1	1800	2400	
	Blue				470	T2	355	500	
ASMB-TTB2-0C3A2	Red	PLCC-6	3.5 x 3.5 x 2.8	115	621	U2	560	790	Black Surface
	Green				530	W2	1400	2000	
	Blue				470	T1	285	380	
ASMB-TTE0-0A3A2	Red	PLCC-6	3.2 x 3.2 x 2.7	110	623	V1	715	880	Black Body White Reflector
	Green				525	X1	1800	2300	
	Blue				469	T2	355	440	
ASMB-TTE2-0B3A2	Red	PLCC-6	3.2 x 3.2 x 2.7	110	623	V1	715	880	Black Body White Reflector
	Green				525	W2	1400	1700	
	Blue				469	T1	285	330	
ASMT-YTB2-0BB02	Red	PLCC-6	3.4 x 2.8x 1.8	120	626	U2	560	745	Black Surface
	Green				525	W1	1125	1600	
	Blue				470	T1	285	380	
ASMT-YTB7-0AA02	Red	PLCC-6	3.4 x 2.8x 1.8	120	622	U2	560	650	Black Surface
	Green				530	W2	1400	1900	
	Blue				470	T1	285	384	
ASMT-YTC2-0BB02	Red	PLCC-6	3.4 x 2.8x 1.8	120	626	T2	355	450	Black Body
	Green				525	U1	450	560	
	Blue				470	R2	140	180	
ASMT-YTC7-0AA02	Red	PLCC-6	3.4 x 2.8x 1.8	110	622	S2	224	330	Black Body
	Green				530	U2	560	1125	
	Blue				470	R1	112.5	160	
ASMT-YTD2-0BB02	Red	PLCC-6	3.4 x 2.8x 1.8	120	626	U2	560	745	White Surface
	Green				525	W1	1125	1600	
	Blue				470	T1	285	380	
ASMT-YTD7-0AA02	Red	PLCC-6	3.4 x 2.8x 1.8	120	622	U2	560	650	White Surface
	Green				530	W1	1400	1900	
	Blue				470	T1	285	384	

## Subminiature Tricolor PLCC4

Part Number	Color	Package	Package Dimension	Viewing Angle (°)	Dominant Wavelength (nm)	Min Intensity (mcd)	Typ IV (mcd)	Test Current (mA)	Features
ASMB-LTC0-0A3A5	Red	PLCC-4	2.1 x 2.1 x 1.0	105	621	200	273	20	Black Body
	Green				525	355	393	20	
	Blue				470	50	72	10	



# High Brightness LEDs

## PLCC-2 (ASMT-UWB1)

ASMT-UWB1-N X<sub>2</sub> X<sub>3</sub> X<sub>4</sub> 2

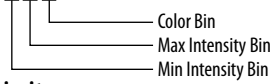

### Color Bin Limits

Individual reel will contain parts from one sub bin only.

Sub Bin		Chromaticity Coordinates				
1A	x	0.2950	0.2920	0.2984	0.3009	
	y	0.2970	0.3060	0.3133	0.3042	
1B	x	0.2920	0.2895	0.2962	0.2984	
	y	0.3060	0.3135	0.3220	0.3133	
1C	x	0.2984	0.2962	0.3028	0.3048	
	y	0.3133	0.3220	0.3304	0.3207	
1D	x	0.2984	0.3048	0.3068	0.3009	
	y	0.3048	0.3130	0.3144	0.3068	
2A	x	0.3048	0.3130	0.3144	0.3068	
	y	0.3207	0.3290	0.3186	0.3113	
2B	x	0.3028	0.3115	0.3130	0.3048	
	y	0.3304	0.3391	0.3290	0.3207	
2C	x	0.3115	0.3205	0.3213	0.3130	
	y	0.3391	0.3481	0.3373	0.3290	
2D	x	0.3130	0.3213	0.3221	0.3144	
	y	0.3290	0.3373	0.3261	0.3186	
3A	x	0.3215	0.3290	0.3290	0.3222	
	y	0.3350	0.3417	0.3300	0.3243	
3B	x	0.3207	0.3290	0.3290	0.3215	
	y	0.3462	0.3538	0.3417	0.3350	
3C	x	0.3290	0.3376	0.3371	0.3290	
	y	0.3538	0.3616	0.3490	0.3417	
3D	x	0.3290	0.3371	0.3366	0.3290	
	y	0.3417	0.3490	0.3369	0.3300	
4A	x	0.3371	0.3451	0.3440	0.3366	
	y	0.3490	0.3554	0.3427	0.3369	
4B	x	0.3376	0.3463	0.3451	0.3371	
	y	0.3616	0.3687	0.3554	0.3490	
4C	x	0.3463	0.3551	0.3533	0.3451	
	y	0.3687	0.3760	0.3620	0.3554	
4D	x	0.3451	0.3533	0.3515	0.3440	
	y	0.3554	0.3620	0.3487	0.3427	
5A	x	0.3530	0.3615	0.3590	0.3512	
	y	0.3597	0.3659	0.3521	0.3465	
5B	x	0.3548	0.3641	0.3615	0.3530	
	y	0.3736	0.3804	0.3659	0.3597	
5C	x	0.3641	0.3736	0.3702	0.3615	
	y	0.3804	0.3874	0.3722	0.3659	
5D	x	0.3615	0.3702	0.3670	0.3590	
	y	0.3659	0.3722	0.3578	0.3521	

### Intensity Bin Limits

Bin ID	Min. (mcd)	Max. (mcd)
X1	1800	2240
X2	2240	2850
Y1	2850	3550
Y2	3550	4500
Z1	4500	5600
Z2	5600	7150

Tolerance of each bin  $\text{it} = \pm 12\%$

6A	x	0.3670	0.3702	0.3825	0.3783
	y	0.3578	0.3722	0.3798	0.3646
6B	x	0.3702	0.3736	0.3869	0.3825
	y	0.3722	0.3874	0.3958	0.3798
6C	x	0.3825	0.3869	0.4006	0.3950
	y	0.3798	0.3958	0.4044	0.3875
6D	x	0.3783	0.3825	0.3950	0.3898
	y	0.3646	0.3798	0.3875	0.3716
7A	x	0.3889	0.3941	0.4080	0.4017
	y	0.3690	0.3848	0.3916	0.3751
7B	x	0.3941	0.3996	0.4146	0.4080
	y	0.3848	0.4015	0.4089	0.3916
7C	x	0.4080	0.4146	0.4299	0.4221
	y	0.3916	0.4089	0.4165	0.3984
7D	x	0.4017	0.4080	0.4221	0.4147
	y	0.3751	0.3916	0.3984	0.3814
8A	x	0.4147	0.4221	0.4342	0.4259
	y	0.3814	0.3984	0.4028	0.3853
8B	x	0.4221	0.4299	0.4430	0.4342
	y	0.3984	0.4165	0.4212	0.4028
8C	x	0.4342	0.4430	0.4562	0.4465
	y	0.4028	0.4212	0.4260	0.4071
8D	x	0.4259	0.4342	0.4465	0.4373
	y	0.3853	0.4028	0.4071	0.3893
9A	x	0.4373	0.4465	0.4582	0.4483
	y	0.3893	0.4071	0.4099	0.3919
9B	x	0.4465	0.4562	0.4687	0.4582
	y	0.4071	0.4260	0.4289	0.4099
9C	x	0.4582	0.4687	0.4813	0.4700
	y	0.4099	0.4289	0.4319	0.4126
9D	x	0.4483	0.4582	0.4700	0.4593
	y	0.3919	0.4099	0.4126	0.3944

### Intensity Bin Select (X<sub>2</sub>X<sub>3</sub>)

Individual reel will contain parts from one half bin only.

X <sub>2</sub>	Minimum Iv Bin
X <sub>3</sub>	Maximum Iv Bin
0	Full Distribution
3	3 half bins starting from X <sub>2</sub> 1
4	4 half bins starting from X <sub>2</sub> 1
5	5 half bins starting from X <sub>2</sub> 1
7	3 half bins starting from X <sub>2</sub> 2
8	4 half bins starting from X <sub>2</sub> 2
9	5 half bins starting from X <sub>2</sub> 2

### Color Bin Limits

Individual reel will contain parts from one sub bin only.

Bin	Sub Bin
A	1A, 1B, 1C, 1D
B	2A, 2B, 2C, 2D
C	3A, 3B, 3C, 3D
D	4A, 4B, 4C, 4D
E	5A, 5B, 5C, 5D
F	6A, 6B, 6C, 6D
G	7A, 7B, 7C, 7D
H	8A, 8B, 8C, 8D
J	9A, 9B, 9C, 9D
K	1A, 1B, 1C, 1D, 2A, 2B, 2C, 2D
L	2A, 2B, 2C, 2D, 3A, 3B, 3C, 3D
M	3A, 3B, 3C, 3D, 4A, 4B, 4C, 4D
N	4A, 4B, 4C, 4D, 5A, 5B, 5C, 5D
P	5A, 5B, 5C, 5D, 6A, 6B, 6C, 6D
R	7A, 7B, 7C, 7D, 8A, 8B, 8C, 8D
S	8A, 8B, 8C, 8D, 9A, 9B, 9C, 9D
0	1A, 1B, 1C, 1D, 2A, 2B, 2C, 2D, 3A, 3B, 3C, 3D, 4A, 4B, 4C, 4D, 5A, 5B, 5C, 5D
1	6A, 6B, 6C, 6D, 7A, 7B, 7C, 7D, 8A, 8B, 8C, 8D, 9A, 9B, 9C, 9D

### Forward Voltage Bin

Bin	Min (V)	Max (V)
F05	2.80	3.00
F06	3.00	3.20
F07	3.20i	3.40
F08	3.40	3.60

Tolerance  $\pm 0.1V$

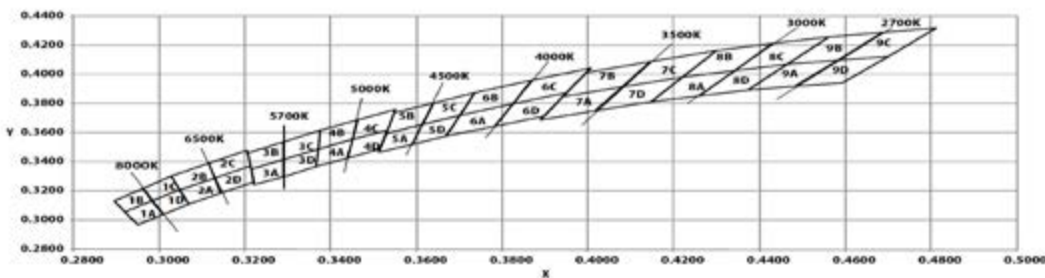

# High Brightness LEDs

## PLCC2, Power PLCC-4, Bicolor PLCC-4 and Tricolor PLCC-4

### Intensity Bin Limits

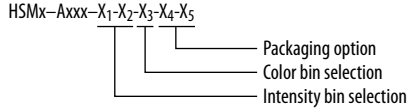

### Intensity Bin Select (X<sub>1</sub>X<sub>2</sub>)

Individual reel will contain parts from 1 half bin only. Single color (see data sheet for bicolor and tricolor).

X <sub>1</sub>	Minimum Iv Bin
X <sub>2</sub>	Number of half Bins
0	Full Distribution
2	2 half bins starting from X <sub>5</sub> 1
3	3 half bins starting from X <sub>5</sub> 1
4	4 half bins starting from X <sub>5</sub> 1
5	5 half bins starting from X <sub>5</sub> 1
6	2 half bins starting from X <sub>5</sub> 2
7	3 half bins starting from X <sub>5</sub> 2
8	4 half bins starting from X <sub>5</sub> 2
9	5 half bins starting from X <sub>5</sub> 2

### Color Bin Selection (X<sub>3</sub>)

Individual reel will contain parts from 1 full bin only. Single color (see data sheet for bicolor and tricolor).

X <sub>3</sub>	
0	Full Distribution
Z	A and B only
Y	B and C only
W	C and D only
V	D and E only
U	E and F only
T	F and G only
S	G and H only
Q	A, B and C only
P	B, C and D only
N	C, D and E only
M	D, E and F only
L	E, F and G only
K	F, G and H only
1	A, B, C and D only
2	E, F, G and H only
3	B, C, D and E only
4	C, D, E and F only
5	A, B, C, D and E only
6	B, C, D, E and F only

### Color Bin Limits for HSMW-Axxx

Bin ID	Limits (Chromaticity Coordinates)
A	X 0.352 0.365 0.365 0.352
	Y 0.377 0.395 0.360 0.341
B	X 0.340 0.352 0.352 0.340
	Y 0.360 0.377 0.341 0.325
C	X 0.327 0.340 0.340 0.327
	Y 0.342 0.360 0.325 0.306
D	X 0.315 0.327 0.327 0.315
	Y 0.325 0.342 0.306 0.290
E	X 0.302 0.315 0.315 0.302
	Y 0.307 0.325 0.290 0.271
F	X 0.290 0.302 0.302 0.290
	Y 0.290 0.307 0.271 0.255

Tolerance of each bin limit = ± 0.02

Bin ID	Intensity (mcd)	
	Min.	Max.
J1	4.50	5.60
J2	5.60	7.20
K1	7.20	9.00
K2	9.00	11.20
L1	11.20	14.00
L2	14.00	18.00
M1	18.00	22.40
M2	22.40	28.50
N1	28.50	35.50
N2	35.50	45.00
P1	45.00	56.00
P2	56.00	71.50
Q1	71.50	90.00
Q2	90.00	112.50
R1	112.50	140.00
R2	140.00	180.00
S1	180.00	224.00
S2	224.00	285.00
T1	285.00	355.00
T2	355.00	450.00
U1	450.00	560.00
U2	560.00	715.00
V1	715.00	900.00
V2	900.00	1125.00
W1	1125.00	1400.00
W2	1400.00	1800.00
X1	1800.00	2240.00
X2	2240.00	2850.00
Y1	2850.00	3550.00
Y2	3550.00	4500.00
Z1	4500.00	5600.00
Z2	5600.00	7150.00
11	7150.00	9000.00
12	9000.00	11250.00
21	11250.00	14000.00
22	14000.00	18000.00

Tolerance of each bin limit = ± 12%

### Color Coordinates Chart for HSMW-Axxx

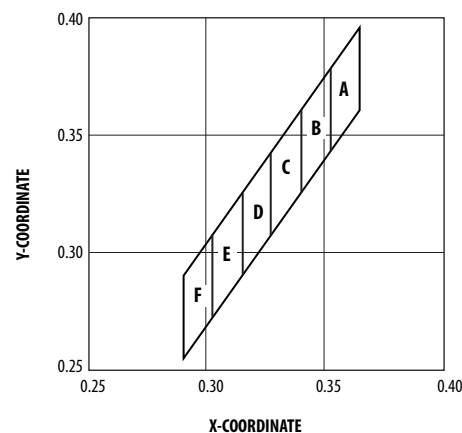

### Color Bin Limits

Color/Bin	Wavelength (nm)	
	Min.	Max.
<b>Blue</b>		
A	460.0	465.0
B	465.0	470.0
C	470.0	475.0
D	475.0	480.0
<b>Cyan</b>		
A	490.0	495.0
B	495.0	500.0
C	500.0	505.0
D	505.0	510.0
<b>Green</b>		
A	515.0	520.0
B	520.0	525.0
C	525.0	530.0
D	530.0	535.0
<b>Yellow Green/Emerald Green</b>		
A	552.5	555.5
B	555.5	558.5
C	558.5	561.5
D	561.5	564.5
E	564.5	567.5
F	567.5	570.5
G	570.5	573.5
H	573.5	576.5
<b>Amber</b>		
A	582.0	584.5
B	584.5	587.0
C	587.0	589.5
D	589.5	592.0
E	592.0	594.5
F	594.5	597.0
<b>Orange</b>		
A	597.0	600.0
B	600.0	603.0
C	603.0	606.0
D	606.0	609.0
E	609.0	612.0
<b>Red Orange</b>		
A	611.0	616.0
B	616.0	620.0
<b>Red</b>		
Full Distribution	620i	635

Tolerance of each bin limit = ± 1nm

### Tricolor/Power PLCC-4

1	Cathode (Color 1)
2	Common Anode
3	Cathode (Color 3)
4	Cathode (Color 2)

### Bicolor PLCC-4

1	Cathode (Color 1)
2	Anode (Color 1)
3	Cathode (Color 2)
4	Anode (Color 2)

# High Brightness LEDs

## PLCC Surface Mount LEDs

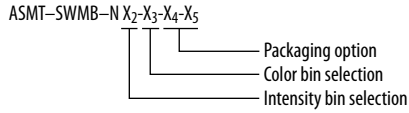

### Intensity Bin Selection (X<sub>2</sub>X<sub>3</sub>)

Individual reel will contain parts from one half bin only.

X <sub>2</sub>	Minimum I <sub>v</sub> Bin
X <sub>3</sub>	Number of half bins
0	Full Distribution
2	2 half bins starting from X <sub>2</sub> 1
3	3 half bins starting from X <sub>2</sub> 1
4	4 half bins starting from X <sub>2</sub> 1
5	5 half bins starting from X <sub>2</sub> 1
6	2 half bins starting from X <sub>2</sub> 2
7	3 half bins starting from X <sub>2</sub> 2
8	4 half bins starting from X <sub>2</sub> 2
9	5 half bins starting from X <sub>2</sub> 2

### Intensity Bin Limits

Bin ID	Min. (mcd)	Max. (mcd)
N1	28.50	35.50
N2	35.50	45.00
P1	45.00	56.00
P2	56.00	71.50
Q1	71.50	90.00
Q2	90.00	112.50
R1	112.50	140.00
R2	140.00	180.00
S1	180.00	224.00
S2	224.00	285.00
T1	285.00	355.00
T2	355.00	450.00
U1	450.00	560.00
U2	560.00	715.00
V1	715.00	900.00
V2	900.00	1125.00
W1	1125.00	1400.00
W2	1400.00	1800.00

Tolerance of each bin limit = ± 12%

## Long Life PLCC-4 ASMT-SWBM

### Packaging Option (X<sub>4</sub>X<sub>5</sub>)

X <sub>4</sub> X <sub>5</sub>	Test Current	Package Type	Reel Size
M1	50 mA	Top Mount	7/13 Inch
M2	30 mA	Top Mount	7/13 Inch
J1	20 mA	Top Mount	7 Inch
J4	20 mA	Top Mount	13 Inch
H1	20 mA	Reverse Mount	7 Inch
H4	20 mA	Reverse Mount	13 Inch

### Color Bin Selection (X<sub>4</sub>)

Individual reel will contain parts from one full bin only.

X <sub>4</sub>	Color Bin Selection
0	Full Distribution
A	1 and 2 only
B	2 and 3 only
C	3 and 4 only
D	4 and 5 only
E	5 and 6 only
F	6 and 7 only
G	1, 2 and 3 only
H	2, 3 and 4 only
J	3, 4 and 5 only
K	4, 5 and 6 only
L	5, 6 and 7 only
M	1, 2, 3 and 4 only
N	2, 3, 4 and 5 only
P	3, 4, 5 and 6 only
Q	4, 5, 6 and 7 only
R	1, 2, 3, 4 and 5 only
S	2, 3, 4, 5 and 6 only
T	3, 4, 5, 6, and 7 only
U	1, 2, 3, 4, 5 and 6 only
V	2, 3, 4, 5, 6 and 7 only
Z	Special Color Bin

### Packaging Option (X<sub>5</sub>)

X <sub>5</sub>	Test Current	Package Type	Reel Size
3	30 mA	Top Mount	7 inch

### V<sub>F</sub> Bin Limits

Bin ID	Min.	Max.
S3	3.20	3.80
S4	3.80	4.35

Tolerance of each bin limit = ± 0.1V

## Color Bin Limits

Bin ID	Limits (Chromaticity Coordinates)				
1	x	0.296	0.291	0.310	0.313
	y	0.259	0.268	0.297	0.284
2	x	0.291	0.285	0.307	0.310
	y	0.268	0.279	0.312	0.297
3	x	0.313	0.310	0.330	0.330
	y	0.284	0.297	0.330	0.310
4	x	0.310	0.307	0.330	0.330
	y	0.297	0.312	0.347	0.330
5	x	0.330	0.330	0.338	0.352
	y	0.310	0.330	0.342	0.344
6	x	0.330	0.330	0.347	0.345
	y	0.330	0.347	0.371	0.352
7	x	0.352	0.338	0.364	0.360
	y	0.344	0.342	0.380	0.357
8	x	0.345	0.347	0.367	0.364
	y	0.352	0.371	0.401	0.380

Tolerance of each bin limit = ± 0.02

## Color Coordinates Chart for ASMT-SWBM

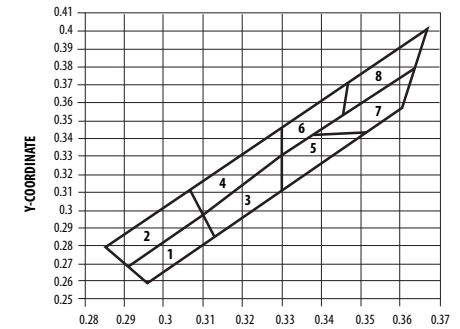

# High Brightness LEDs

## High Brightness Tricolor PLCC-4 and PLCC-6

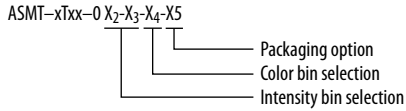

### For ASMB-BTE1

X <sub>2</sub>	Min Iv Bin (Minimum Intensity Bin)		
	Red	Green	Blue
B	U1	W1	T1

### For ASMB-MTB0/MTB1

X <sub>2</sub>	Min Iv Bin (Minimum Intensity Bin)		
	Red	Green	Blue
A	U1	W1	T1

### For ASMB-MTC1

X <sub>2</sub>	Min Iv Bin (Minimum Intensity Bin)		
	Red	Green	Blue
A	S1	U2	R1

### For ASMB-TTB0/TTB2

X <sub>2</sub>	Min Iv Bin (Minimum Intensity Bin)		
	Red	Green	Blue
A	U2	X1	T2
C	U2	W2	T1

### For ASMB-TTE0/TTE2

X <sub>2</sub>	Min Iv Bin (Minimum Intensity Bin)		
	Red	Green	Blue
A	V1	X1	T2
B	V1	W2	T1

### For ASMT-YTB2/YTD2

X <sub>2</sub>	Min Iv Bin (Minimum Intensity Bin)		
	Red	Green	Blue
B	U2	W1	T1

### For ASMT-YTC2

X <sub>2</sub>	Min Iv Bin (Minimum Intensity Bin)		
	Red	Green	Blue
A	T2	U1	R2

### For ASMT-YTB7/D7

X <sub>2</sub>	Min Iv Bin (Minimum Intensity Bin)		
	Red	Green	Blue
A	U2	W2	T1

### For ASMT-YTC7

X <sub>2</sub>	Min Iv Bin (Minimum Intensity Bin)		
	Red	Green	Blue
A	S2	U2	R1

### For ASMB-BTE1 /MTB0/MTB1/TTB0/TTB2/ TTE0/TTE2

X <sub>3</sub>	Number of Half Bin from X <sub>2</sub>		
	Red	Green	Blue
3	3	3	3

### For ASMT-YTB2/YTD2

X <sub>3</sub>	Number of Half Bin from X <sub>2</sub>		
	Red	Green	Blue
B	3	3	3

### For ASMT-YTC2/YTB7/YTD7/YTC7

X <sub>3</sub>	Number of Half Bin from X <sub>2</sub>		
	Red	Green	Blue
A	3	3	3

### Intensity Bin Limits

Bin ID	Min (mcd)	Max (mcd)
R1	112.5	140
R2	140	180
S1	180	224
S2	224	285
T1	285	355
T2	355	450
U1	450	560
U2	560	715
V1	715	900
V2	900	1125
W1	1125	1400
W2	1400	1800
X1	1800	2240
X2	2250	2850
Y1	2850	3550

Tolerance of each bin limit = ± 12%

### Color Bin Selection (X<sub>4</sub>)

#### For ASMB-MTB0/MTB1

X <sub>4</sub>	Color Bin Combination		
	Red	Green	Blue
A	Full Distribution	A,B,D	A,B,C

#### For ASMB-BTE1

X <sub>4</sub>	Color Bin Combination		
	Red	Green	Blue
3	Full Distribution	A,B,D	A,B,C

### Color Bin Selection (X<sub>4</sub>)

#### For ASMB-TTB0/TTB2

X <sub>4</sub>	Color Bin Combination		
	Red	Green	Blue
A	Full distribution	E,A,B	A,B,C

#### For ASMB-TTE0/TTE2

X <sub>4</sub>	Color Bin Combination		
	Red	Green	Blue
A	Full distribution	A,B,C	A,B,C

#### For ASMT-YTB2/YTC2/YTD2

X <sub>4</sub>	Color Bin Combination		
	Red	Green	Blue
0	Full distribution	A,B,C	A,B,C,D,E

#### For ASMT-YTB7/YTC7/YTD7

X <sub>4</sub>	Color Bin Combination		
	Red	Green	Blue
0	Full distribution	A,B,C	A,B,C,D

Note: please refer to respective datasheet for color bin limits information

Packaging Option (X<sub>5</sub>)

Please refer to respective datasheet for related information.

# High Brightness LEDs

## Super 0.5W Power PLCC-4

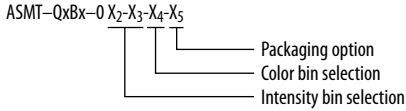

### Flux Bin Selection (X<sub>2</sub>X<sub>3</sub>)

Individual reel will contain parts from one bin only

X <sub>2</sub>	Min Flux Bin
X <sub>3</sub>	Max Flux Bin

### Flux Bin Limits

Bin ID	Min. (lm)	Max. (lm)
0	3.40	4.30
A	4.30	5.50
B	5.50	7.00
C	7.00	9.00
D	9.00	11.50
E	11.50	15.00
F	15.00	19.50
G	19.50	25.50
H	25.50	33.00
J	33.00	43.00
K	43.00	56.00
L	56.00	73.00

Tolerance of each bin limit = ± 12%

### V<sub>F</sub> Binning for AllInGaP Devices (ASMT-QAxx/QHxx/QRxx)

Bin ID	Min.	Max.
2D	2.35	2.50
2E	2.50	2.65
2F	2.65	2.80
2G	2.80	2.95
2H	2.95	3.10
2J	3.10	3.25
2K	3.25	3.40
2L	3.40	3.55
2M	3.55	3.70
2N	3.70	3.85

Tolerance of each bin limit = ± 0.1V

### Color Bin Selection (X<sub>4</sub>)

Individual reel will contain parts from one full bin only.

X <sub>4</sub>	
0	Full Distribution
A	1 and 2 only
B	2 and 3 only
C	3 and 4 only
D	4 and 5 only
E	5 and 6 only
G	1, 2 and 3 only
H	2, 3 and 4 only
J	3, 4 and 5 only
K	4, 5 and 6 only
M	1, 2, 3 and 4 only
N	2, 3, 4 and 5 only
P	3, 4, 5 and 6 only
R	1, 2, 3, 4 and 5 only
S	2, 3, 4, 5 and 6 only
Z	Special Color Bin

### V<sub>F</sub> Bin Limits for InGaN Devices (ASMT-QBxx/QGxx)

Bin ID	Min.	Max.
S5	3.20	3.50
S6	3.50	3.80
S7	3.80	4.10

Tolerance of each bin limit = ± 0.1V

### Color Bin Limits

Color/Bin	Wavelength (nm)	
	Min.	Max.
<b>Blue</b>		
1	460.0	465.0
2	465.0	470.0
8	450.0	455.0
9	455.0	460.0
<b>Green</b>		
1	515.0	520.0
2	520.0	525.0
3	525.0	530.0
4	530.0	535.0
<b>Amber</b>		
2	583.0	586.0
3	586.0	589.0
4	589.0	592.0
5	592.0	595.0
6	595.0	598.0
<b>Red Orange</b>		
1	611.0	616.0
2	616.0	620.0
3	620.0	625.0
<b>Red</b>		
Full Distribution	620.0	635.0

Tolerance of each bin limit = ±1nm

### Packaging Option (X<sub>5</sub>)

X <sub>5</sub>	Test Current)	Package Type	Reel Size
E	150 mA	Top Mount	7 inch

# High Brightness LEDs

## Super 0.5W White Power PLCC-4

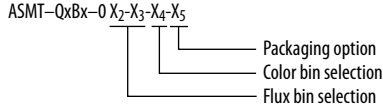

### Flux Bin Selection (X<sub>2</sub>X<sub>3</sub>)

Individual reel will contain parts from one bin only

X <sub>2</sub>	Min Flux Bin
X <sub>3</sub>	Min Flux Bin

### Flux Bin Limits

Bin ID	Min. (lm)	Max. (lm)
O	3.40	4.30
A	4.30	5.50
B	5.50	7.00
C	7.00	9.00
D	9.00	11.50
E	11.50	15.00
F	15.00	19.50
G	19.50	25.50
H	25.50	33.00
J	33.00	43.00
K	43.00	56.00
L	56.00	73.00

Tolerance of each bin limit = ± 12%

### Color Bin Selection (X<sub>4</sub>) for ASMT-QWBx

Individual reel will contain parts from one sub bin only.

X <sub>4</sub>	
O	Full Distribution
A	5K and 5L only
B	6K and 6L only
C	7K and 7L only
D	8K and 8L only
E	5K and 6K only
F	5L and 6L only
G	6K and 7K only
H	6L and 7L only
J	7K and 8K only
K	7L and 8L only
L	5K, 5L, 6K and 6L only
M	6K, 6L, 7K and 7L only
N	7K, 7L, 8K and 8L only
Z	Special binning

### Color Bin Limits for ASMT-QWBx

Bin ID	Sub Bin ID	Limits (Chromaticity Coordinates)					
5K	5Ka	x	0.296	0.304	0.302	0.294	
		y	0.259	0.270	0.276	0.264	
	5Kb	x	0.294	0.302	0.300	0.291	
		y	0.264	0.276	0.281	0.268	
	5Kc	x	0.304	0.313	0.312	0.302	
		y	0.270	0.284	0.291	0.276	
	5Kd	x	0.302	0.312	0.310	0.300	
		y	0.276	0.291	0.297	0.281	
	5L	5La	x	0.291	0.300	0.298	0.288
			y	0.268	0.281	0.288	0.274
		5Lb	x	0.288	0.298	0.295	0.285
			y	0.274	0.288	0.294	0.279
5Lc		x	0.300	0.310	0.309	0.298	
		y	0.281	0.297	0.305	0.288	
5Ld		x	0.298	0.309	0.307	0.295	
		y	0.288	0.305	0.312	0.294	
6K	6Ka	x	0.313	0.322	0.321	0.312	
		y	0.284	0.297	0.305	0.291	
	6Kb	x	0.312	0.321	0.320	0.310	
		y	0.291	0.305	0.314	0.297	
	6Kc	x	0.322	0.330	0.330	0.321	
		y	0.297	0.310	0.320	0.305	
	6Kd	x	0.321	0.330	0.330	0.320	
		y	0.305	0.320	0.330	0.314	

Tolerance of each bin limit = ± 0.02

### Color Bin Limits cont.

Bin ID	Sub Bin ID	Limits (Chromaticity Coordinates)				
6L	6La	x	0.310	0.320	0.319	0.309
		y	0.297	0.314	0.322	0.305
	6Lb	x	0.309	0.319	0.318	0.307
		y	0.305	0.322	0.329	0.312
	6Lc	x	0.320	0.330	0.330	0.319
		y	0.314	0.330	0.339	0.322
	6Ld	x	0.319	0.330	0.330	0.318
		y	0.322	0.339	0.347	0.329
7K	7Ka	x	0.330	0.336	0.337	0.330
		y	0.310	0.320	0.330	0.320
	7Kb	x	0.330	0.337	0.337	0.330
		y	0.320	0.330	0.341	0.330
	7Kc	x	0.336	0.343	0.344	0.337
		y	0.320	0.331	0.341	0.330
	7Kd	x	0.337	0.344	0.345	0.337
		y	0.330	0.341	0.352	0.341
7L	7La	x	0.330	0.337	0.337	0.330
		y	0.330	0.341	0.349	0.339
	7Lb	x	0.330	0.337	0.338	0.330
		y	0.339	0.349	0.358	0.347
	7Lc	x	0.337	0.345	0.346	0.337
		y	0.341	0.352	0.362	0.349
	7Ld	x	0.337	0.346	0.347	0.338
		y	0.349	0.362	0.371	0.358
8K	8Ka	x	0.343	0.351	0.352	0.344
		y	0.331	0.343	0.354	0.341
	8Kb	x	0.344	0.352	0.354	0.345
		y	0.341	0.354	0.364	0.352
	8Kc	x	0.351	0.360	0.362	0.352
		y	0.343	0.357	0.369	0.354
	8Kd	x	0.352	0.362	0.364	0.354
		y	0.354	0.369	0.380	0.364
8L	8La	x	0.345	0.354	0.355	0.346
		y	0.352	0.364	0.375	0.362
	8Lb	x	0.346	0.355	0.356	0.347
		y	0.362	0.375	0.385	0.371
	8Lc	x	0.354	0.364	0.366	0.355
		y	0.364	0.380	0.391	0.375
	8Ld	x	0.355	0.366	0.367	0.356
		y	0.375	0.391	0.401	0.385

Tolerance of each bin limit = ± 0.02

# High Brightness LEDs

Color Coordinates Chart for ASMT-QWBx

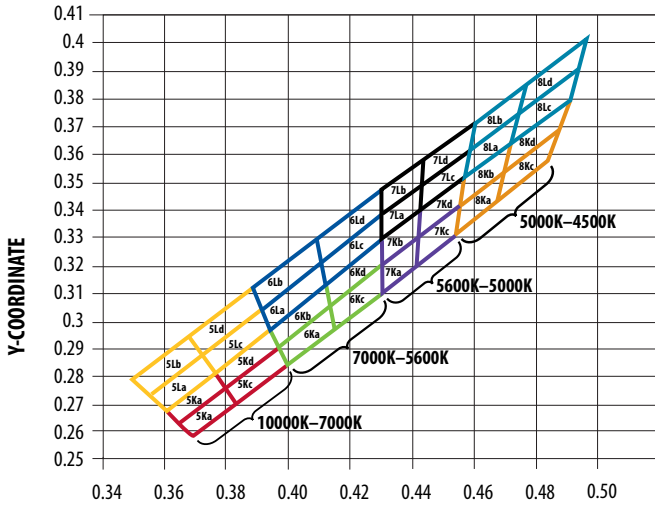

Color Coordinates Chart for ASMT-QYBx

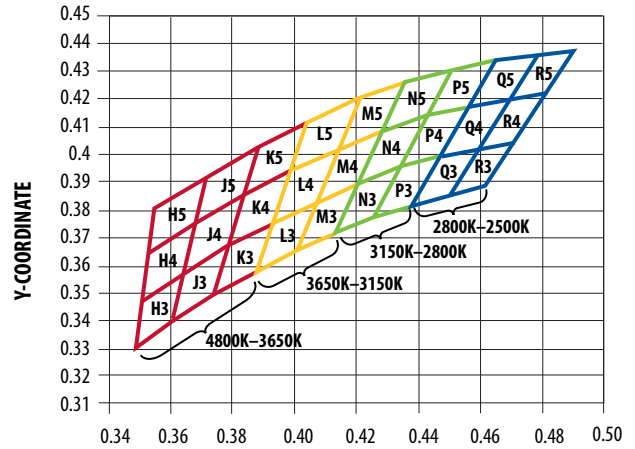

## Color Bin Selection (X<sub>4</sub>) for ASMT-QYBx

Individual reel will contain parts from one sub bin only.

X <sub>4</sub>	Description
0	Full Distribution
A	H, J and K only
B	H, J, K, L and M only
C	L and M only
D	L, M, N and P only
E	N and P only
F	N, P, Q and R only
G	Q and R only
Z	Special Color Bin

## Color Bin Limits for ASMT-QYBx

Bin ID	Sub Bin ID	Limits (Chromaticity Coordinates)				
L	L3	x	0.387	0.400	0.407	0.393
		y	0.358	0.366	0.384	0.376
	L4	x	0.393	0.407	0.414	0.399
		y	0.376	0.384	0.402	0.395
	L5	x	0.399	0.414	0.421	0.405
		y	0.395	0.402	0.420	0.412
M	M3	x	0.400	0.413	0.421	0.407
		y	0.366	0.372	0.390	0.384
	M4	x	0.407	0.421	0.429	0.414
		y	0.384	0.390	0.409	0.402
	M5	x	0.414	0.429	0.436	0.421
		y	0.402	0.409	0.426	0.420
N	N3	x	0.413	0.425	0.434	0.421
		y	0.372	0.378	0.396	0.390
	N4	x	0.421	0.434	0.443	0.429
		y	0.390	0.396	0.414	0.409
	N5	x	0.429	0.443	0.451	0.436
		y	0.409	0.414	0.430	0.426
P	P3	x	0.425	0.438	0.447	0.434
		y	0.378	0.382	0.400	0.396
	P4	x	0.434	0.447	0.456	0.443
		y	0.396	0.400	0.417	0.414
	P5	x	0.443	0.456	0.465	0.451
		y	0.414	0.417	0.434	0.430
Q	Q3	x	0.438	0.450	0.460	0.447
		y	0.382	0.386	0.403	0.400
	Q4	x	0.447	0.460	0.470	0.456
		y	0.400	0.403	0.420	0.417
	Q5	x	0.456	0.470	0.479	0.465
		y	0.417	0.420	0.436	0.434

## Color Bin Limits for ASMT-QYBx

Bin ID	Sub Bin ID	Limits (Chromaticity Coordinates)				
R	R3	x	0.450	0.462	0.472	0.460
		y	0.386	0.389	0.405	0.403
	R4	x	0.460	0.472	0.482	0.470
		y	0.403	0.405	0.422	0.420
	R5	x	0.470	0.482	0.491	0.479
		y	0.420	0.422	0.437	0.436

Tolerance of each bin limit = ± 0.02

## Packaging Option (X<sub>5</sub>)

X <sub>5</sub>	Test Current	Package Type	Reel Size
E	150 mA	Top Mount	7 inch

## Color Bin Limits for ASMT-QWBx

Bin ID	Sub Bin ID	Limits (Chromaticity Coordinates)				
H	H3	x	0.348	0.360	0.364	0.350
		y	0.332	0.341	0.358	0.348
	H4	x	0.350	0.364	0.367	0.352
		y	0.348	0.358	0.376	0.365
	H5	x	0.352	0.367	0.371	0.354
		y	0.365	0.376	0.392	0.381
J	J3	x	0.360	0.373	0.378	0.364
		y	0.341	0.350	0.368	0.358
	J4	x	0.364	0.378	0.383	0.367
		y	0.358	0.368	0.386	0.376
	J5	x	0.367	0.383	0.388	0.371
		y	0.376	0.386	0.403	0.392
K	K3	x	0.373	0.387	0.393	0.378
		y	0.350	0.358	0.376	0.368
	K4	x	0.378	0.393	0.399	0.383
		y	0.368	0.376	0.395	0.386
	K5	x	0.383	0.399	0.405	0.388
		y	0.386	0.395	0.412	0.403

Surface Mount PLCC LEDs

# High Brightness LEDs

## Super 0.25W and 0.5W Power PLCC4 Cool White and Warm White Luminous Flux Bin and Color Bin (ASMT-UWBx/UYBx/QWBx/QYBx)

### Super 0.25W Power PLCC4 Cool White

ASMT-UWBx-N X<sub>2</sub>-X<sub>3</sub>-X<sub>4</sub>-8

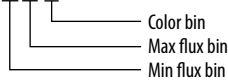

### Super 0.25W Power PLCC4 Warm White

ASMT-UYBx-N X<sub>2</sub>-X<sub>3</sub>-X<sub>4</sub>-8

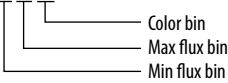

### Super 0.5W Power PLCC4 Cool White (ASMT-QWBx)

ASMT-QWBx-N X<sub>2</sub>-X<sub>3</sub>-X<sub>4</sub>-E

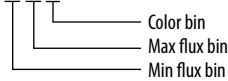

### Super 0.5W Power PLCC4 Warm White (ASMT-QYBx)

ASMT-QYBx-N X<sub>2</sub>-X<sub>3</sub>-X<sub>4</sub>-E

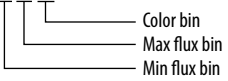

### Color Bin (X<sub>4</sub>)

Individual reel will contain parts from one sub bin only.

Sub Bin	Chromaticity Coordinates
	0.2950 0.2920 0.2984 0.3009
1A	x 0.2950 0.2920 0.2984 0.3009 y 0.2970 0.3060 0.3133 0.3042
1B	x 0.2920 0.2895 0.2962 0.2984 y 0.3060 0.3135 0.3220 0.3133
1C	x 0.2984 0.2962 0.3028 0.3048 y 0.3133 0.3220 0.3304 0.3207
1D	x 0.2984 0.3048 0.3068 0.3009 y 0.3133 0.3207 0.3113 0.3042
2A	x 0.3048 0.3130 0.3144 0.3068 y 0.3207 0.3290 0.3186 0.3113
2B	x 0.3028 0.3115 0.3130 0.3048 y 0.3304 0.3391 0.3290 0.3207
2C	x 0.3115 0.3205 0.3213 0.3130 y 0.3391 0.3481 0.3373 0.3290
2D	x 0.3130 0.3213 0.3221 0.3144 y 0.3290 0.3373 0.3261 0.3186
3A	x 0.3215 0.3290 0.3290 0.3222 y 0.3350 0.3417 0.3300 0.3243
3B	x 0.3207 0.3290 0.3290 0.3215 y 0.3462 0.3538 0.3417 0.3350
3C	x 0.3290 0.3376 0.3371 0.3290 y 0.3538 0.3616 0.3490 0.3417
3D	x 0.3290 0.3371 0.3366 0.3290 y 0.3417 0.3490 0.3369 0.3300
4A	x 0.3371 0.3451 0.3440 0.3366 y 0.3490 0.3554 0.3427 0.3369
4B	x 0.3376 0.3463 0.3451 0.3371 y 0.3616 0.3687 0.3554 0.3490
4C	x 0.3463 0.3551 0.3533 0.3451 y 0.3687 0.3760 0.3620 0.3554
4D	x 0.3451 0.3533 0.3515 0.3440 y 0.3554 0.3620 0.3487 0.3427
5A	x 0.3530 0.3615 0.3590 0.3512

### Flux Bin Selection (X<sub>2</sub>X<sub>3</sub>)

Individual reel will contain parts from one bin only

X <sub>2</sub>	Min Flux Bin
X <sub>3</sub>	Min Flux Bin

### Flux Bin Limits

Bin ID	Min. (lm)	Max. (lm)
A	18.1	23.5
B	23.5	30.6
C	30.6	35.2
D	35.2	39.8
E	39.8	45.7
F	45.7	51.7
G	51.7	56.8
H	56.8	62
J	62	67.2
K	67.2	73.9

Tolerance of each bin limit = ± 12%.

### Color Bin (X<sub>4</sub>)

Individual reel will contain parts from one sub bin only.

X <sub>4</sub>	Sub Bin
A	1A, 1B, 1C, 1D
B	2A, 2B, 2C, 2D
C	3A, 3B, 3C, 3D
D	4A, 4B, 4C, 4D
E	5A, 5B, 5C, 5D
F	6A, 6B, 6C, 6D
G	7A, 7B, 7C, 7D
H	8A, 8B, 8C, 8D
J	9A, 9B, 9C, 9D
K	1A, 1B, 1C, 1D, 2A, 2B, 2C, 2D
L	2A, 2B, 2C, 2D, 3A, 3B, 3C, 3D
M	3A, 3B, 3C, 3D, 4A, 4B, 4C, 4D
N	4A, 4B, 4C, 4D, 5A, 5B, 5C, 5D
P	5A, 5B, 5C, 5D, 6A, 6B, 6C, 6D
R	7A, 7B, 7C, 7D, 8A, 8B, 8C, 8D
S	8A, 8B, 8C, 8D, 9A, 9B, 9C, 9D
0	1A, 1B, 1C, 1D, 2A, 2B, 2C, 2D, 3A, 3B, 3C, 3D, 4A, 4B, 4C, 4D, 5A, 5B, 5C, 5D, 6A, 6B, 6C, 6D
1	7A, 7B, 7C, 7D, 8A, 8B, 8C, 8D, 9A, 9B, 9C, 9D

8C	x	0.4342	0.4430	0.4562	0.4465
	y	0.4028	0.4212	0.4260	0.4071
8D	x	0.4259	0.4342	0.4465	0.4373
	y	0.3853	0.4028	0.4071	0.3893
9A	x	0.4373	0.4465	0.4582	0.4483
	y	0.3893	0.4071	0.4099	0.3919
9B	x	0.4465	0.4562	0.4687	0.4582
	y	0.4071	0.4260	0.4289	0.4099
9C	x	0.4582	0.4687	0.4813	0.4700
	y	0.4099	0.4289	0.4319	0.4126
9D	x	0.4483	0.4582	0.4700	0.4593
	y	0.3919	0.4099	0.4126	0.3944

### Forward Voltage Bin

Bin	Min (V)	Max (V)
F05	2.80	3.00
F06	3.00	3.20
F07	3.20	3.40
F08	3.40	3.60

Tolerance ± 0.1V

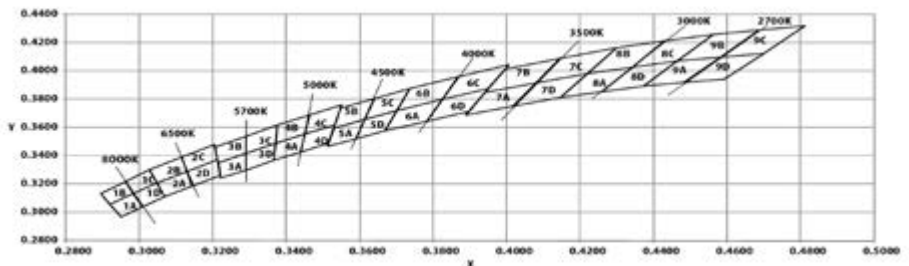



# High Brightness LEDs

## Subminiature Tricolor PLCC4 ASMB-LTCC

### Part Numbering System

A	S	M	B	-	L	T	C	0	-	0	X <sub>1</sub>	X <sub>2</sub>	X <sub>3</sub>	X <sub>4</sub>
---	---	---	---	---	---	---	---	---	---	---	----------------	----------------	----------------	----------------

Code	Description	Option		
X <sub>1</sub>	Minimum intensity bin	A	Red: bin S2	Red: bin S2,T1,T2
			Green: bin T2	Green: bin T2,U1,U2
			Blue: bin P2	Blue: bin P2,Q1,Q2
X <sub>2</sub>	Number of intensity bins	3	3 intensity bins from minimum	
X <sub>3</sub>	Color bin combination	A	Red: full distribution	
			Green: bin A, B, C	
			Blue: bin A, B, C	
X <sub>4</sub>	Test option	5	Test current R&G=20mA, B=10mA	

### Bin Information

#### Intensity Bins (CAT)

Color	Bin ID	Luminous Intensity (mcd)	
		Min.	Max.
Red	S2	200	280
	T1	280	355
	T2	355	450
Green	T2	355	450
	U1	450	560
	U2	560	710
Blue	P2	50	71
	Q1	71	90
	Q2	90	112

Tolerance ±12%

#### Color Bin (BIN) Red

Bin ID	Dominant wavelength (nm)		Chromaticity coordinates (for reference only)	
	Min.	Max.	C <sub>x</sub>	C <sub>y</sub>
-	617	630	0.6850	0.3149
			0.6815	0.3150
			0.7042	0.2924
			0.7079	0.2920

Tolerance ±1 nm

#### Color Bin (BIN) Green

Bin ID	Dominant wavelength (nm)		Chromaticity coordinates (for reference only)	
	Min.	Max.	C <sub>x</sub>	C <sub>y</sub>
A	520	526	0.0743	0.8338
			0.1261	0.7337
			0.1645	0.7249
			0.1223	0.8227
B	523	529	0.0979	0.8316
			0.1450	0.7319
			0.1841	0.7150
			0.1468	0.8104
C	526	532	0.1223	0.8228
			0.1645	0.7249
			0.2029	0.7039
			0.1702	0.7965

Tolerance ±1 nm

#### Color Bin (BIN) Blue

Bin ID	Dominant wavelength (nm)		Chromaticity coordinates (for reference only)	
	Min.	Max.	C <sub>x</sub>	C <sub>y</sub>
A	465	469	0.1355	0.0399
			0.1751	0.0986
			0.1680	0.1094
			0.1267	0.0534
B	467	471	0.1314	0.0459
			0.1718	0.1034
			0.1638	0.1167
			0.1215	0.0626
C	469	473	0.1267	0.0534
			0.1680	0.1094
			0.1593	0.1255
			0.1158	0.0736

Tolerance ±1 nm

# High Brightness LEDs

## Package Dimensions

**PLCC-2 Top Mount**

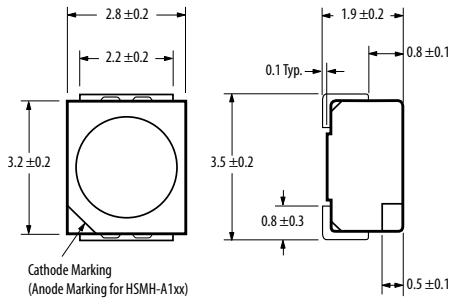

**PLCC-2 Reverse Mount**

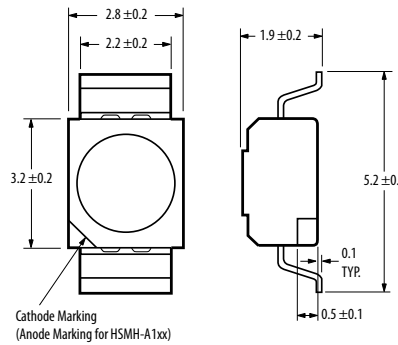

**Power PLCC-4 with Lens**

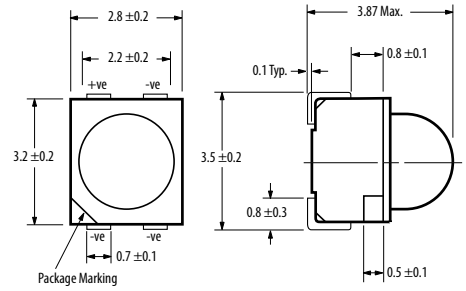

**BiColor/TriColor PLCC4/Power PLCC-4**

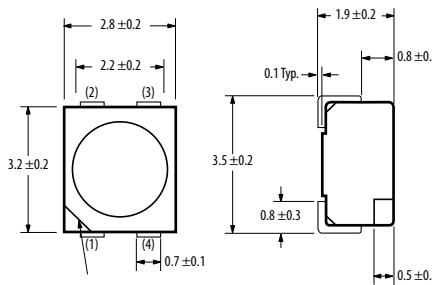

**Super 0.5W Power PLCC-4**

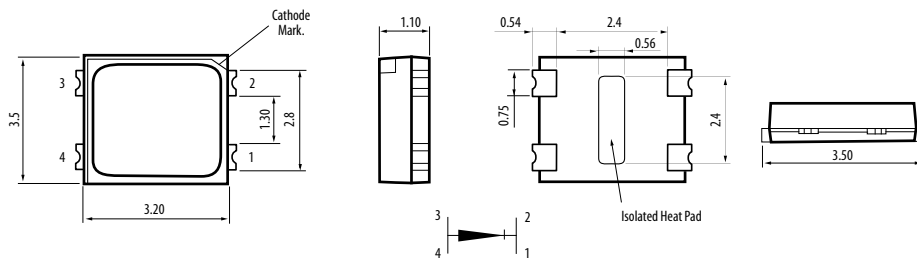
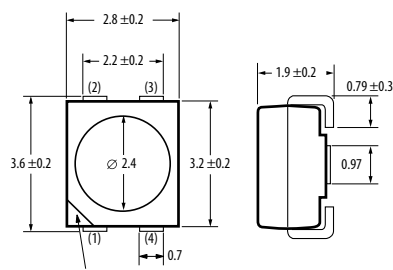

**High Brightness Tricolor PLCC-4**

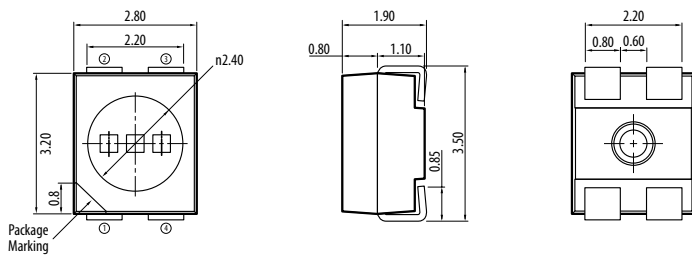

# High Brightness LEDs

## Package Dimensions

### High Brightness Tricolor PLCC-6 ASMB-TTB0/TTB2

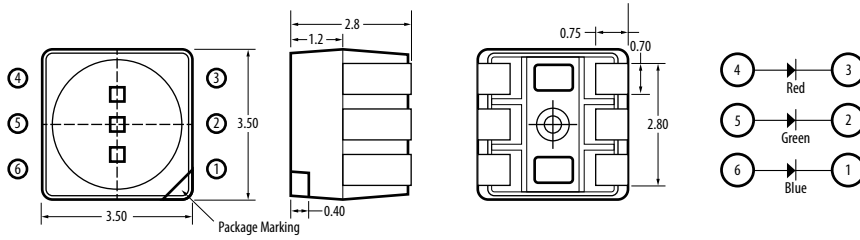

Note:  
Refer to respective product datasheet for pin configuration.

Note:  
Diagram represents the overall package dimension for ASMT-YTB2/YTC2/YTD2/YTB7/YTC7/YTD7. ASMTYTC2/YTC7 is black body, while ASMT-YTD2/YTD7 is white surface.

### High Brightness Tricolor PLCC-6 ASMB-TTE0/TTE2

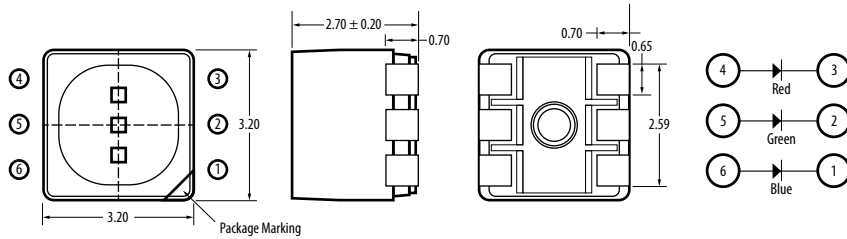

### High Brightness Tricolor PLCC-6 ASMT-YTB2/YTC2/YTD2/YTB7/YTC7/YTD7

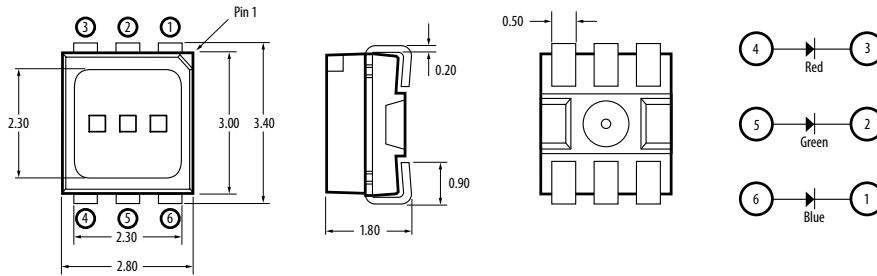

### PLCC4 ASMB-LTC0

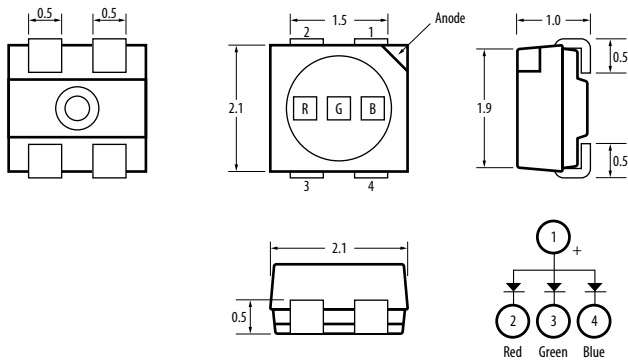

# High Brightness LEDs



## Mini PLCC-2 Surface Mount LEDs

### Description

Avago Technologies' ASMT-TxBM-Nxxxx Mini PLCC-2 SMT LEDs are designed specifically for use in Automotive Interior applications. They have a wide viewing angle of 110 degree making them ideally suited for instrument cluster panel, push button, HVAC and ambient decorative lighting applications in automotive interiors.

The LEDs are packed in EIA-compliant tape and reel to facilitate easy pick and place assembly. Every reel will be shipped in single intensity and color bin, to provide close uniformity.

### Features and Benefits

- Industry standard Mini PLCC-2
- High reliability LED package
- High brightness using InGaN dice technologies
- High optical efficiency
- Wide viewing angle at 110°
- Available is 8mm carrier tape on 7-inch reel
- Stable and consistent performance with minimum degradation
- JEDEC MSL 2

### Target Markets Applications

- Interior automotive
- Instrument panel backlighting
- Central console backlighting
- Navigation and audio system backlighting
- Push button backlighting
- Ambient illumination
- Car puddle lighting

### Mini PLCC2

Part Number	Color	Color Temperature	Intensity Bin (Luminous Intensity @ 20mA)	Luminous Intensity @ 20mA (typ)	Max.Current	Viewing Angle	Packaging
ASMT-TWBM-NV702	Cool White	4500 - 8000K	T2 (355 - 450 mcd) U1 (450 - 560 mcd) U2 (560 - 715 mcd) V1 (715 - 900 mcd) V2 (900 - 1125 mcd) W1 (1125-1400mcd) W2 (1400-1800mcd)	1100	20mA	120°	Reel
ASMT-TBBM-NS402	Blue	Not Applicable	P2 (56 - 71.5 mcd) Q1 (71.5 - 90 mcd) Q2 (90 - 112.5 mcd) R1 (112.5 - 140 mcd) R2 (140 - 180 mcd) S1 (180-224mcd) S2 (224-285mcd) T1 (285-355mcd) T2 (355-450mcd)	285	20mA	120°	Reel
ASMT-TGBM-NU3B2	Green	Not Applicable	T1 (285 - 355 mcd) T2 (3555 - 450 mcd) U1 (450 - 560 mcd) U2 (560 - 715 mcd) V1 (715 - 900 mcd)	600	20mA	120°	Reel

#### Notes

1.  $\theta_{1/2}$  is the off-axis angle where the luminous intensity is  $\frac{1}{2}$  the peak intensity.
2.  $\Phi_V$  is the total luminous flux output as measured with an integrating sphere at mono pulse conditions.
3. Tolerance =  $\pm 12\%$ .

# High Brightness LEDs

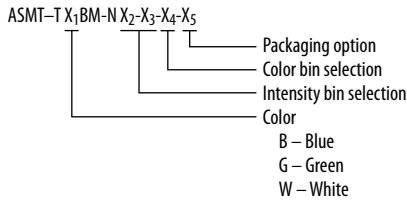

## Part Numbering System

### Device Color (X<sub>1</sub>)

B	Blue
G	Green

### Intensity Bin Select (X<sub>2</sub>X<sub>3</sub>)

Individual reel will contain parts from one half bin only

X <sub>2</sub>	Min IV Bin
X <sub>3</sub>	Number of half bins
0	Full Distribution
2	2 half bins starting from X21
3	3 half bins starting from X21
4	4 half bins starting from X21
5	5 half bins starting from X21
6	2 half bins starting from X22
7	3 half bins starting from X22
8	4 half bins starting from X22
9	5 half bins starting from X22

### Device Color (X<sub>1</sub>)

W	White
---	-------

### Intensity Bin Select (X<sub>2</sub>X<sub>3</sub>)

Individual reel will contain parts from one half bin only

X <sub>2</sub>	Min IV Bin
X <sub>3</sub>	Number of half bins
0	Full Distribution
2	2 half bins starting from X21
3	3 half bins starting from X21
4	4 half bins starting from X21
5	5 half bins starting from X21
6	2 half bins starting from X22
7	3 half bins starting from X22
8	4 half bins starting from X22
9	5 half bins starting from X22

### Intensity Bin Limits

Bin ID	Min (mcd)	Max (mcd)
P1	45.0	56.0
P2	56.0	71.5
Q1	71.5	90.0
Q2	90.0	112.5
R1	112.5	140.0
R2	140.0	180.0
S1	180.0	224.0
S2	224.0	285.0
T1	285.0	355.0
T2	355.0	450.0
U1	450.0	560.0
U2	560.0	715.0
V1	715.0	900.0
V2	900.0	1125.0

Tolerance of each bin limit = ± 12%

### Intensity Bin Limits

Bin ID	Min (mcd)	Max (mcd)
T1	285.0	355.0
T2	355.0	450.0
U1	450.0	560.0
U2	560.0	715.0
V1	715.0	900.0
V2	900.0	1125.0
W1	1125.0	1400.00
W2	1400.00	1800.00

Bin ID	Min (mcd)	Max (mcd)
X1	1800.00	2240.00
X2	2240.00	2850.00

Tolerance of each bin limit = ± 12%

### Color Bin Select (X<sub>4</sub>)

Individual reel will contain parts from one half bin only

X4	
0	Full Distribution
A	1 and 2 only
B	2 and 3 only
C	3 and 4 only
G	1, 2 and 3 only
H	2, 3 and 4 only
Z	Special binning

### Packaging Option (X<sub>5</sub>)

Option	Test Current	Package Type	Reel Size
2	20mA	Top Mount	7 inch

### Color Bin Limits

Blue	Min. (nm)	Max. (nm)
1	460.0	465.0
2	465.0	470.0
3	470.0	475.0
4	475.0	480.0

Green	Min. (nm)	Max. (nm)
1	515.0	520.0
2	520.0	525.0
3	525.0	530.0
4	530.0	535.0

Tolerance of each bin limit = ± 1%

### Color Bin Select (X<sub>4</sub>)

Individual reel will contain parts from one half bin only

X4	
0	Full Distribution
A	5K and 5L only
B	6K and 6L only
C	7K and 7L only
D	8K and 8L only
E	5K and 6K only
F	5L and 6L only
G	6K and 7K only
H	6L and 7L only
J	7K and 8K only
K	7L and 8L only
L	5K, 5L, 6K and 6L only
M	6K, 6L, 7K and 7L only
N	7K, 7L, 8K and 8L only
Z	Special binning

### Color Bin Limits

Blue	Min. (nm)	Max. (nm)
1	460.0	465.0
2	465.0	470.0
3	470.0	475.0
4	475.0	480.0

Green	Min. (nm)	Max. (nm)
1	515.0	520.0
2	520.0	525.0
3	525.0	530.0
4	530.0	535.0

Tolerance of each bin limit = ± 1%

### Packaging Option (X<sub>5</sub>)

Option	Test Current	Package Type	Reel Size
2	20mA	Top Mount	7 inch

# High Brightness LEDs

## Color Bin (X<sub>4</sub>)

Individual reel will contain parts from one sub bin only.

Bin ID	Sub Bin ID	Limits (Chromaticity Coordinates)					
5K	5Ka	x	0.296	0.304	0.302	0.294	
		y	0.259	0.270	0.276	0.264	
	5Kb	x	0.294	0.302	0.300	0.291	
		y	0.264	0.276	0.281	0.268	
	5Kc	x	0.304	0.313	0.312	0.302	
		y	0.270	0.284	0.291	0.276	
	5Kd	x	0.302	0.312	0.310	0.300	
		y	0.276	0.291	0.297	0.281	
5L	5La	x	0.291	0.300	0.298	0.288	
		y	0.268	0.281	0.288	0.274	
	5Lb	x	0.288	0.298	0.295	0.285	
		y	0.274	0.288	0.294	0.279	
	5Lc	x	0.300	0.310	0.309	0.298	
		y	0.281	0.297	0.305	0.288	
	5Ld	x	0.298	0.309	0.307	0.295	
		y	0.288	0.305	0.312	0.294	
	6K	6Ka	x	0.313	0.322	0.321	0.312
			y	0.284	0.297	0.305	0.291
		6Kb	x	0.312	0.321	0.320	0.310
			y	0.291	0.305	0.314	0.297
6Kc		x	0.322	0.330	0.330	0.321	
		y	0.297	0.310	0.320	0.305	
6Kd		x	0.321	0.330	0.330	0.320	
		y	0.305	0.320	0.330	0.314	
6L	6La	x	0.310	0.320	0.319	0.309	
		y	0.297	0.314	0.322	0.305	
	6Lb	x	0.309	0.319	0.318	0.307	
		y	0.305	0.322	0.329	0.312	
	6Lc	x	0.320	0.330	0.330	0.319	
		y	0.314	0.330	0.339	0.322	
	6Ld	x	0.319	0.330	0.330	0.318	
		y	0.322	0.339	0.347	0.329	

Bin ID	Sub Bin ID	Limits (Chromaticity Coordinates)				
7K	7Ka	x	0.330	0.336	0.337	0.330
		y	0.310	0.320	0.330	0.320
	7Kb	x	0.330	0.337	0.337	0.330
		y	0.320	0.330	0.341	0.330
	7Kc	x	0.336	0.343	0.344	0.337
		y	0.320	0.331	0.341	0.330
	7Kd	x	0.337	0.344	0.345	0.337
		y	0.330	0.341	0.352	0.341
7L	7La	x	0.330	0.337	0.337	0.330
		y	0.330	0.341	0.349	0.339
	7Lb	x	0.330	0.337	0.338	0.330
		y	0.339	0.349	0.358	0.347
	7Lc	x	0.337	0.345	0.346	0.337
		y	0.341	0.352	0.362	0.349
	7Ld	x	0.337	0.346	0.347	0.338
		y	0.349	0.362	0.371	0.358
8K	8Ka	x	0.343	0.351	0.352	0.344
		y	0.331	0.343	0.354	0.341
	8Kb	x	0.344	0.352	0.354	0.345
		y	0.341	0.354	0.364	0.352
	8Kc	x	0.351	0.360	0.362	0.352
		y	0.343	0.357	0.369	0.354
	8Kd	x	0.352	0.362	0.364	0.354
		y	0.354	0.369	0.380	0.364
8L	8La	x	0.345	0.354	0.355	0.346
		y	0.352	0.364	0.375	0.362
	8Lb	x	0.346	0.355	0.356	0.347
		y	0.362	0.375	0.385	0.371
	8Lc	x	0.354	0.364	0.366	0.355
		y	0.364	0.380	0.391	0.375
	8Ld	x	0.355	0.366	0.367	0.356
		y	0.375	0.391	0.401	0.385

Tolerance of each bin limit = ±0.02

## Color Coordinates Chart

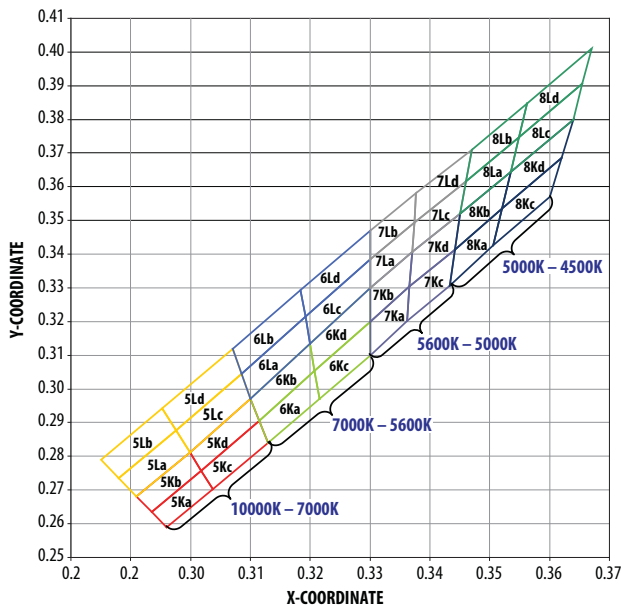

## Package Dimensions

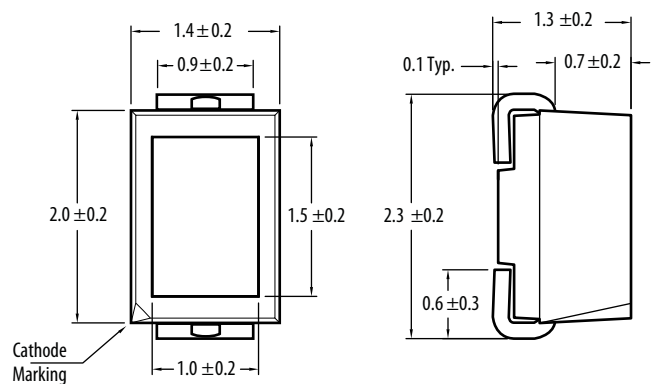

- Notes:
1. All dimensions in millimeters.
  2. Terminal Finish: Ag plating.
  3. Encapsulation material: Silicone resin.



## Envisium™ Power PLCC-4 Surface Mount LEDs

### Description

Envisium™ is the premier class of mid-Power LEDs using TS AllnGaP chip technology. Envisium™ LEDs offer unparalleled performance, engineering and design flexibility.

Envisium™ Power PLCC-4 SMT LEDs, available in red, red-orange and amber, fill the need for mid-power illumination capabilities between Avago Technologies' conventional PLCC-4 products, and the Super 0.5W Power PLCC-4. The Power PLCC-4 package can be driven at high current due to its superior design, and is able to dissipate the heat more efficiently than conventional PLCC-2 SMT LEDs. It also offers much higher quality and reliability and superior mechanical characteristics to reduce tombstoning, prevent delamination and improve pick-and-place assembly.

The reliability and performance characteristics of these mid-power LEDs, such as their  $-40^{\circ}\text{C}$  to  $+100^{\circ}\text{C}$  operating temperature range, make them uniquely suitable for use in harsh conditions such as automotive applications, and in electronic signs and signals. To facilitate easy pick and place assembly, the LEDs are packed in EIA-compliant tape and reel. Every reel is shipped in single intensity and color bin (except for red) to provide close uniformity.

These LEDs are compatible with both IR solder reflow and through-the-wave (TTW) soldering processes.

### Features and Benefits

- Industry Standard PLCC-4 (plastic leaded chip carrier) form factor
- High reliability Power PLCC-4 package
- High brightness with optimum flux performance using TS AllnGaP dice technologies
- Available in red, red orange and amber colors
- High optical efficiency
- Higher ambient temperature at the same current possible compared to PLCC-2
- Super wide 120-degree viewing angle
- Well-suited for backlighting applications
- Supplied in EIA-standard 8 mm carrier tape on 7 inch reel
- Compatible with both IR and TTW soldering processes

### Applications

- Interior automotive
  - Instrument panel backlighting
  - Central console backlighting
  - Navigation and audio system lighting
  - Push button backlighting
- Exterior automotive
  - Turn signals
  - Side repeater lamps
  - CHMSLs (center high-mounted stop light)
  - Rear combination lamps
  - Puddle lights
- Electronic signs and signals
  - Channel lettering
  - Contour lighting
  - Indoor variable message signs
- Office automation, home appliances, industrial equipment
  - Front panel backlighting
  - Push button backlighting
  - Display backlighting

# High Brightness LEDs

## Envisium PLCC-4 Surface Mount LED

Part Number	Color	Typ. Dominant Wavelength $\lambda_D$ (nm) <sup>1</sup>	Typ. Viewing Angle $2\theta_{1/2}$ (°) <sup>2</sup>	Intensity Bin	Min. IV (mcd)	Max. IV (mcd)	Total Flux $\Phi_V$ (mlm) <sup>4,5</sup> Typ.	Typ. VF (V)	Test Current (mA)
ASMC-PRB9-TV005	AllInGaP Red	630.0	120	V1	630.00	1000.00	2600.00	2.8	50
		630.0	120	V2	790.00	1260.00	3300.00	2.8	50
		630.0	120	W1	1000.00	1600.00	–	2.8	50
ASMC-PHB9-TW005	AllInGaP Red Orange	617.0	120	W1	1000.00	1600.00	4300.00	2.8	50
		617.0	120	W2	1200.00	2020.00	5000.00	2.8	50
		617.0	120	X1	1580.00	2500.00	–	2.8	50
ASMC-PAB9-TV005	AllInGaP Amber	592.0	120	V1	630.00	1000.00	3000.00	2.8	50
		592.0	120	V2	790.00	1260.00	3800.00	2.8	50
		592.0	120	W1	1000.00	1600.00	–	2.8	50

### Notes:

- The dominant wavelength,  $\lambda_D$ , is derived from the CIE Chromaticity Diagram and represents the color of the device.
- $\theta_{1/2}$  is the off-axis angle where the luminous intensity is 1/2 the peak intensity.
- The luminous intensity,  $I_V$ , is measured at the mechanical axis of the lamp package. The actual peak of the spatial radiation pattern may not be aligned with this axis.
- $\Phi$  is the total luminous flux output as measured with an integrating sphere at mono pulse conditions.

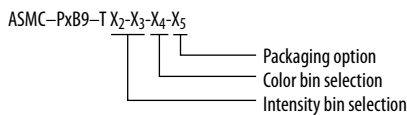

### Color Bin Selection (X<sub>4</sub>)

An individual reel will contain parts from one bin only

X <sub>4</sub>	
0	Full Distribution
A	1 and 2 only
B	2 and 3 only
C	3 and 4 only
D	4 and 5 only
E	5 and 6 only
G	1, 2 and 3 only
H	2, 3 and 4 only
J	3, 4 and 5 only
K	4, 5 and 6 only
M	1, 2, 3 and 4 only
N	2, 3, 4 and 5 only
P	3, 4, 5 and 6 only
R	1, 2, 3, 4 and 5 only
S	2, 3, 4, 5 and 6 only

### Intensity Bin Selection (X<sub>2</sub>X<sub>3</sub>)

X <sub>2</sub>	Min. I <sub>V</sub> Bin
X <sub>3</sub>	Number of half bins
0	Full Distribution
2	2 half bins starting from X <sub>2</sub> 1
3	3 half bins starting from X <sub>2</sub> 1
4	4 half bins starting from X <sub>2</sub> 1
5	5 half bins starting from X <sub>2</sub> 1
6	2 half bins starting from X <sub>2</sub> 2
7	3 half bins starting from X <sub>2</sub> 2
8	4 half bins starting from X <sub>2</sub> 2
9	5 half bins starting from X <sub>2</sub> 2

### Color Bin Limits

Amber/Yellow	Min. (nm)	Max. (nm)
1	582.0	584.5
2	584.5	587.0
3	587.0	589.5
4	589.5	592.0
5	592.0	594.5
6	594.5	597.0

Red Orange	Min. (nm)	Max. (nm)
1	611.0	616.0
2	616.0	620.0

Red	Min. (nm)	Max. (nm)
Full Distribution		

Tolerance of each bin limit = ±1 nm

### Intensity Bin Limits

Bin ID	Min. (mcd)	Max. (mcd)
V1	715.00	900.00
V2	900.00	1125.00
W1	1125.00	1400.00
W2	1400.00	1800.00
X1	1800.00	2240.00
X2	2240.00	2850.00

Tolerance of each bin limit = ±12%

### Packaging Option (X<sub>5</sub>)

X <sub>5</sub>	Test Current	Package Type	Reel Size
5	50 mA	Top Mount	7 inch



# High Brightness LEDs

## Envisium PLCC-4 Surface Mount LED

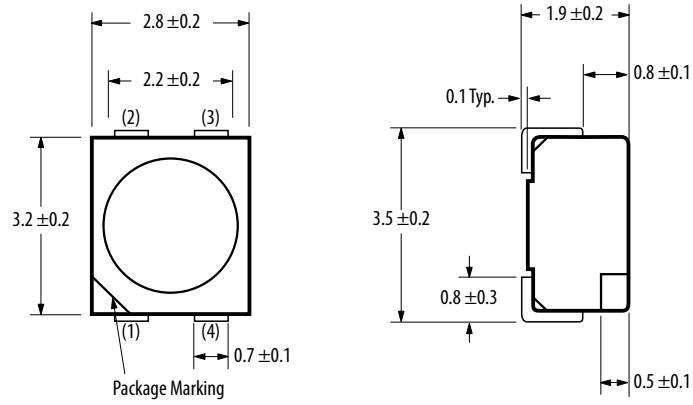

Note:  
All dimensions in millimeters.

Envisium Power PLCC-4	
1	Cathode
2	Anode
3	Cathode
4	Cathode

# High Brightness LEDs

## High Power LEDs



### Description

Avago High Power and Mini High Power LED is a high performance, energy efficient device which can handle high thermal and high driving current. The White High Power LED is available in a wide range of color. For white color, the color temperature ranges from 2700K to 10000K.

The low profile package design and ultra small footprint is suitable for a wide variety of applications especially where space and height is a constraint.

The package is compatible with reflow soldering process. It is packed in EIA-compliant tape and reel option.

### Features and Benefits

- Available in full range of colors: Red, Red Orange, Amber, Green, Blue, Royal Blue, Cyan, Cool White, Neutral White and Warm White
- Energy efficient
- Compatible with reflow soldering process
- High current operation
- Long operation life
- Wide viewing angle
- Silicone encapsulation
- Non-ESD sensitive (threshold > 16kV)

### Typical Applications

- Sign backlight
- Safety, exit and emergency sign lightings
- Specialty lighting such as task lighting and reading lights
- Retail display
- Commercial lighting
- Accent or marker lightings, strip or step lightings
- Portable lightings, bicycle head lamp, torch lights.
- Decorative lighting
- Architectural lighting
- Street lighting
- Tunnel lighting
- Contour lighting
- Traffic signal

# High Brightness LEDs

## 1W High Power LEDs

Part Number	Color	Color Temperature (K)/Wavelength (nm)	Flux Bin (Luminous Flux/Radiometric Power @ 350mA)	Luminous Flux (lm) @ 350mA (typ)	Luminous Flux (lm) @ 700mA (typ)	Max. Current	Viewing Angle	Electrically Isolated Metal Slug	Packaging
ASMT-AW00-NUW01	Cool White	4500 - 10,000K (1)	U(87.4-99.6lm); V(99.6-113.6lm); W(113.6-129.5lm)	95lm	-	500mA	140	Yes	Tube and Reel <sup>(2)</sup>
ASMT-AN00-NUW01	Neutral White	4500 - 10,000K (1)	U(87.4-99.6lm); V(99.6-113.6lm); W(113.6-129.5lm)	90lm	-	500mA	140	Yes	Tube and Reel <sup>(2)</sup>
ASMT-AY00-NUV00	Warm White	2700 - 3500K <sup>(1)</sup>	U (87.4-99.6lm); V(99.6-113.6lm)	95lm	-	500mA	140	Yes	Tube <sup>(2)</sup>
ASMT-AL00-NNQ00	Royal Blue	440-460nm <sup>(3,4)</sup>	N (275-355mW); P (355-435mW); Q(435-515mW)	355mW	-	500mA	140	Yes	Tube <sup>(2)</sup>
ASMT-AB00-NMP00	Blue	460-480nm <sup>(3)</sup>	M(13.9-18.1lm); N(18.1-23.5lm); P(23.5-30.6lm)	18lm	-	500mA	140	Yes	Tube <sup>(2)</sup>
ASMT-AC00-NSU00	Cyan	490-520nm <sup>(3)</sup>	S(51.7-67.2lm); T(67.2-87.4lm); U(87.4-99.6lm)	75lm	-	500mA	140	Yes	Tube <sup>(2)</sup>
ASMT-AG00-NUV00	Green	515-535nm <sup>(3)</sup>	U (87.4-99.6lm); V(99.6-113.6lm)	105lm	-	500mA	140	Yes	Tube <sup>(2)</sup>
ASMT-AA00-ARS00	Amber	587-597nm <sup>(3)</sup>	R(39.8-51.7lm); S(51.7-67.2lm)	50lm	-	500mA	140	No	Tube <sup>(2)</sup>
ASMT-AH00-ARS00	Red-Orange	610-620nm	R(39.8-51.7lm); S(51.7-67.2lm)	50lm	-	500mA	140	No	Tube <sup>(2)</sup>
ASMT-AR00-ARS00	Red	620-635nm	R(39.8-51.7lm); S(51.7-67.2lm)	50lm	-	500mA	140	No	Tube <sup>(2)</sup>
ASMT-AR00-AST00	Red	620-635nm	S(51.7-67.2lm); T(67.2-87.4lm)	65lm	-	500mA	140	No	Tube <sup>(2)</sup>

### Notes

1. Narrow Color Temperature selections are available on request.
2. All above listed LEDs are also available in Reel packing.
3. Narrow color bin selections for blue, green, amber, royal-blue, and cyan are available on request.
4. For royal-blue, the wavelength shown in the above table is peak wavelength.

## 3W High Power LEDs

Part Number	Color	Color Temperature (K)/Wavelength (nm)	Flux Bin (Luminous Flux/Radiometric Power @ 350mA)	Luminous Flux (lm) @ 350mA (typ)	Luminous Flux (lm) @ 700mA (typ)	Max. Current	Viewing Angle	Electrically Isolated Metal Slug	Packaging
ASMT-AW31-NVX00	Cool White	4500-10000K	V(99.6-113.6lm); W(113.6-129.5lm); X(129.5-147.7lm)	120lm	205lm	700mA	140	Yes	Tube <sup>(2)</sup>
ASMT-AN31-NWX00	Neutral White	3500-4500K	W(113.6-129.5lm); X(129.5-147.7lm)	120lm	205lm	700mA	140	Yes	Tube <sup>(2)</sup>
ASMT-AY31-NUW00	Warm White	2,700 - 3,500K <sup>(1)</sup>	U(87.4-99.6lm); V(99.6-113.6lm); W(113.6-129.5lm)	95lm	162lm	700mA	140	Yes	Tube <sup>(2)</sup>
ASMT-AB31-NNP00	Blue	455-475nm	N(18.1-23.5lm); P(23.5-30.6lm)	23	39	700mA	140	Yes	Tube <sup>(2)</sup>
ASMT-AL31-NRS00	Royal Blue	440-460nm <sup>(3,4)</sup>	R(515-595mW); S(595-685mW)	600mW	1022mW	700mA	140	Yes	Tube <sup>(2)</sup>
ASMT-AG31-NUV00	Green	515-535nm (3)	U(87.4-99.6lm); V(99.6-113.6lm)	105lm	168lm	700mA	140	Yes	Tube <sup>(2)</sup>
ASMT-AA30-ARS00	Amber	587-597nm <sup>(3)</sup>	R(39.8-51.7lm); S(51.7-67.2lm)	50lm	94lm	700mA	140	No	Tube <sup>(2)</sup>
ASMT-AH30-ARS00	Red-Orange	610-620nm	R(39.8-51.7lm); S(51.7-67.2lm)	50lm	94lm	700mA	140	No	Tube <sup>(2)</sup>
ASMT-AR30-ARS00	Red	620-635nm	R(39.8-51.7lm); S(51.7-67.2lm)	50lm	94lm	700mA	140	No	Tube <sup>(2)</sup>
ASMT-AR30-AST00	Red	620-635nm	S(51.7-67.2lm); T(67.2-87.4lm)	60lm	112lm	700mA	140	Yes	Tube <sup>(2)</sup>

### Notes

1. Narrow Color Temperature selections are available on request.
2. All above listed LEDs are also available in Reel packing.
3. Narrow color bin selections for blue, green, amber and royal-blue are available on request.
4. For royal-blue, the wavelength shown in the above table is peak wavelength.

# High Brightness LEDs

## 1W Mini High Power LEDs

Part Number	Color	Color Temperature (K)/Wavelength (nm)	Flux Bin (Luminous Flux/Radiometric Power @ 350mA)	Luminous Flux (lm) @ 350mA (typ)	Luminous Flux (lm) @ 700mA (typ)	Max. Current	Viewing Angle	Electrically Isolated Metal Slug	Packaging
ASMT-JW11-NWX01	Cool White	4500 - 10,000K <sup>(1)</sup>	W(113.6-129.5lm); X(129.5-147.7lm)	120lm	-	500mA	140	Yes	Tape & Reel
ASMT-JN11-NWX01	Neutral White	3500 - 4500K <sup>(1)</sup>	W(113.6-129.5lm); X(129.5-147.7lm)	120lm	-	500mA	140	Yes	Tape & Reel
ASMT-JY11-NVW01	Warm White	2700 - 3500K <sup>(1)</sup>	V(99.6-113.6lm); W(113.6-129.5lm)	105lm	-	500mA	140	Yes	Tape & Reel
ASMT-JL11-NNQ01	Royal Blue	440-460nm <sup>(2,3)</sup>	N(275-355mW); P(355-435mW); Q(435-515mW)	355mW	-	500mA	165	Yes	Tape & Reel
ASMT-JB11-NNQ01	Blue	455-475nm <sup>(2)</sup>	N(275-355mW); P(355-435mW); Q(435-515mW)	24lm	-	500mA	165	Yes	Tape & Reel
ASMT-JC11-NTU01	Cyan	490-520nm <sup>(2)</sup>	T(67.2-87.4lm); U(87.4-99.6lm)	75lm	-	500mA	165	Yes	Tape & Reel
ASMT-JG11-NUW01	Green	515-535nm <sup>(2)</sup>	U(87.4-99.6lm); V(99.6-113.6lm); W(113.6-129.5lm)	110lm	-	500mA	165	Yes	Tape & Reel
ASMT-JA10-ARS01	Amber	587-597nm <sup>(2)</sup>	R(39.8-51.7lm); S(51.7-67.2lm)	48lm	-	500mA	165	No	Tape & Reel
ASMT-JH10-ARS01	Red-Orange	610-620nm	R(39.8-51.7lm); S(51.7-67.2lm)	48lm	-	500mA	165	No	Tape & Reel
ASMT-JR10-AST01	Red	620-635nm	S(51.7-67.2lm); T(67.2-87.4lm)	60lm	-	500mA	165	Yes	Tape & Reel

### Notes

1. Narrow Color Temperature selections are available on request.
2. Narrow color bin selections for blue, green, amber, royal-blue, and cyan are available on request.
3. For royal-blue, the wavelength shown in the above table is peak wavelength.

## 3W Mini High Power LEDs

Part Number	Color	Color Temperature (K)/Wavelength (nm)	Flux Bin (Luminous Flux/Radiometric Power @ 350mA)	Luminous Flux (lm) @ 350mA (typ)	Luminous Flux (lm) @ 700mA (typ)	Max. Current	Viewing Angle	Electrically Isolated Metal Slug	Packaging
ASMT-JW32-NWY01	Cool White	4500-10000K	W(113.6-129.5lm); X(129.5-147.7lm); Y(147.7-168.4lm)	140	239	700mA	140	Yes	Tape & Reel
ASMT-JW32-NWYJ1	Cool White	5000-6300K	W(113.6-129.5lm); X(129.5-147.7lm); Y(147.7-168.4lm)	140	239	700mA	140	Yes	Tape & Reel
ASMT-JN32-NWY01	Neutral White	3500-4500K	W(113.6-129.5lm); X(129.5-147.7lm); Y(147.7-168.4lm)	140	239	700mA	140	Yes	Tape & Reel
ASMT-JN32-NWYH1	Neutral White	3800-4500K	W(113.6-129.5lm); X(129.5-147.7lm); Y(147.7-168.4lm)	140	239	700mA	140	Yes	Tape & Reel
ASMT-JY32-NWY01	Warm White	2700-3500K	W(113.6-129.5lm); X(129.5-147.7lm); Y(147.7-168.4lm)	130	222	700mA	140	Yes	Tape & Reel
ASMT-JY32-NWYK1	Warm White	3050-3500K	W(113.6-129.5lm); X(129.5-147.7lm); Y(147.7-168.4lm)	130	222	700mA	140	Yes	Tape & Reel
ASMT-JL31-NRS01	Royal Blue	440-460nm <sup>(3)</sup>	R(515-595mW); S(595-685lm)	600mW	1020mW	700mA	165	Yes	Tape & Reel
ASMT-JG31-NUW01	Green	515-535nm <sup>(2)</sup>	U(87.4-99.6lm); V(99.6-113.6lm); W(113.6-129.5lm)	110lm	176lm	700mA	165	Yes	Tape & Reel
ASMT-JA30-ARS01	Amber	587-597nm <sup>(2)</sup>	R(39.8-51.7lm); S(51.7-67.2lm)	48lm	86lm	700mA	165	No	Tape & Reel
ASMT-JH30-ARS01	Red-Orange	610-620nm	R(39.8-51.7lm); S(51.7-67.2lm)	48lm	86lm	700mA	165	No	Tape & Reel
ASMT-JR30-AST01	Red	620-635nm	S(51.7-67.2lm); T(67.2-87.4lm)	58lm	104lm	700mA	165	Yes	Tape & Reel
ASMT-JD30-ALN01	Deep Red	650-670nm <sup>(3)</sup>	L(175-225mW); N(275-355mW)	240mW	480mW	700mA	165	Yes	Tape & Reel

### Notes

1. Narrow Color Temperature selections are available on request.
2. Narrow color bin selections for blue, green, amber and royal-blue are available on request.
3. For royal-blue and deep red, the wavelength shown in the above table is peak wavelength.

# High Brightness LEDs

## High CRI 3W Mini High Power LEDs

Part Number	Color	Color Temperature (K)/ Wavelength (nm)	Flux Bin (Luminous Flux/Radiometric Power @ 350mA)	Luminous Flux (lm) @ 350mA (typ)	Luminous Flux (lm) @ 700mA (typ)	Max. Current	Viewing Angle	Electrically Isolated Metal Slug	Packaging
ASMT-JW33-NVW00	Cool White	4500-10000K	V(99.6-113.6lm); W(113.6-129.5lm)	110lm	196lm	700mA	140	Yes	Tape & Reel
ASMT-JN33-NVW00	Neutral White	3500-4500K	V(99.6-113.6lm); W(113.6-129.5lm)	110lm	196lm	700mA	140	Yes	Tape & Reel
ASMT-JY33-NTU01	Warm White	2700-3500K	T(67.2-87.4lm); U(87.4-99.6lm); V(99.6-113.6lm)	90lm	160lm	700mA	140	Yes	Tape & Reel

**Notes**

1. Narrow Color Temperature selections are available on request.

# High Brightness LEDs

## Package Dimensions

### 1W & 3W High Power LED

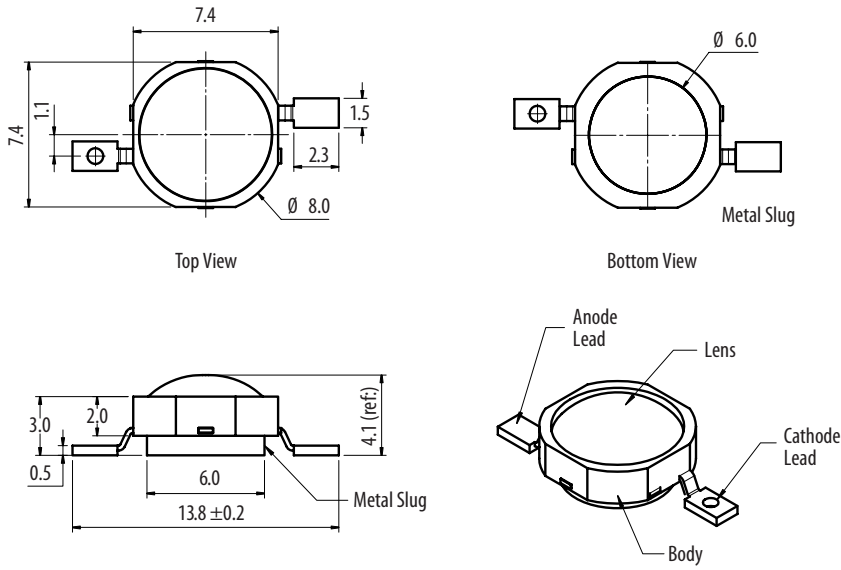

### 1W & 3W Mini High Power LED

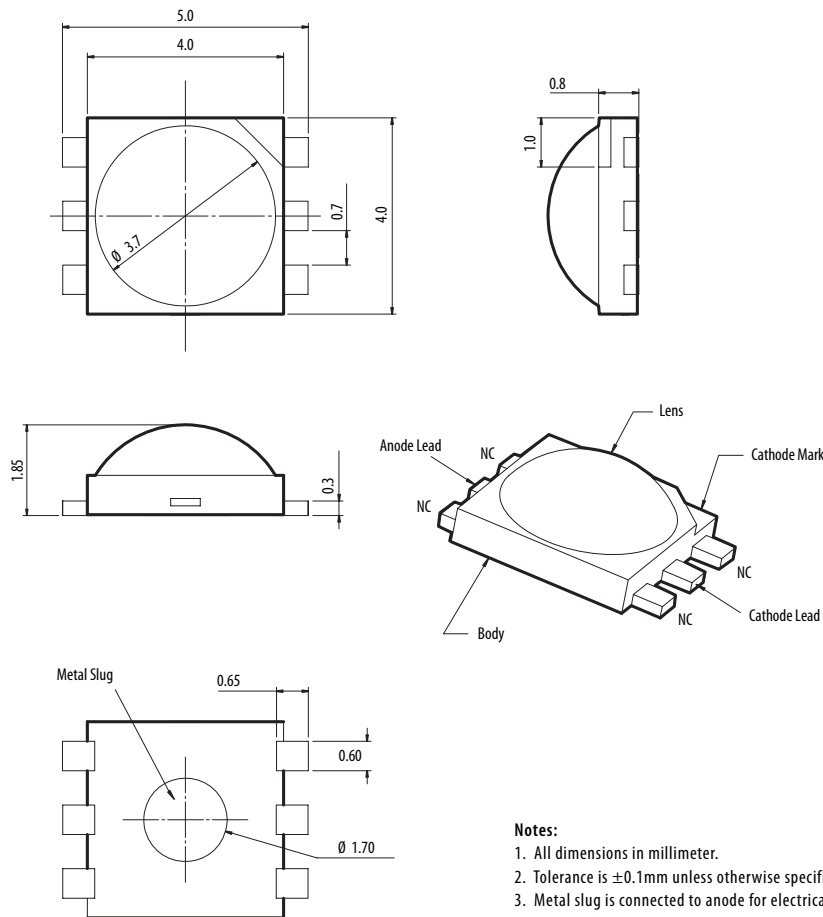

**Notes:**

1. All dimensions in millimeter.
2. Tolerance is  $\pm 0.1$ mm unless otherwise specified.
3. Metal slug is connected to anode for electrically non-isolated package.
4. Terminal finish: Ag plating.

## Moonstone™ High Power LEDs



### Description

High Power LED is a high-performance, energy-efficient device that can handle high-thermal and high-driving current. The exposed pad design has excellent heat transfer from the package to the motherboard. The low-profile package design is suitable for a wide variety of applications, especially where height is a constraint. The package is compatible with the SMT reflow soldering process. This will give more freedom and flexibility to the light source designer.



### Features and Benefits

- Available in White, Blue, Green, Red and Amber color
- Energy efficient
- Exposed pad for excellent heat transfer
- Suitable for SMT process
- High-current operation
- Long operation life
- Wide viewing angle
- Silicone encapsulation
- Available in emitter and module

### Typical Applications

- Portable (flashlight, bicycle headlight)
- Reading light
- Architectural lighting
- Garden lighting
- Decorative lighting
- Street lighting
- Retail lighting
- Contour lighting
- Sign backlighting

### Specifications

- InGaN: 3.2V (typ) at 350 mA  
3.6 V (typ) at 700 mA
- AllnGaP: 2.1 V (typ) at 350 mA
- Viewing angle of 120° and 110°

# High Brightness LEDs

## 1W Moonstone™ High Power LEDs

Part Number	Color	Color Temperature (K)/ Wavelength (nm)	Flux Bin (Luminous Flux/Radiometric Power @ 350mA)	Luminous Flux (lm) @ 350mA (typ)	Luminous Flux (lm) @ 500mA (typ)	Max. Current	Viewing Angle	Electrically Isolated Metal Slug	Packaging
ASMT-MW06-NMN00	Cool White	4,000 - 10,000K	M(95-110lm); N (110-125lm)	105	144	500mA	110	Yes	Tube
ASMT-MWB6-NMN00	Cool White	4,000 - 10,000K	M(95-110lm); N (110-125lm)	100	137	500mA	110	Yes	Tube
ASMT-MW04-NMN00	Cool White	4,000 - 10,000K	M (95-110lm); N (110-125lm)	105	–	350mA	110	Yes	Tube <sup>(2)</sup>
ASMT-MWB4-NMN00	Cool White	4,000 - 10,000K	M (95-110lm); N (110-125lm)	95	–	350mA	110	Yes	Tube <sup>(2)</sup>
ASMT-MY06-NMN00	Warm White	2,600K-4,000K	M (95-110lm); N (110-125lm)	100	137	500mA	110	Yes	Tube <sup>(2)</sup>
ASMT-MYB6-NMN00	Warm White	2,600K-4,000K	M (95-110lm); N (110-125lm);	98	134	500mA	110	Yes	Tube <sup>(2)</sup>
ASMT-MY04-NLM00	Warm White	2,600K-4,000K	L (73-95lm); M (95-110lm)	100	–	350mA	110	Yes	Tube <sup>(2)</sup>
ASMT-MYB4-NLM00	Warm White	2,600K-4,000K	L (73-95lm); M (95-110lm)	90	–	350mA	110	Yes	Tube <sup>(2)</sup>
ASMT-MB00-NDFO0	Blue	455-475nm <sup>(3)</sup>	D(11.5-15lm); E(15-19.5lm); F(19.5-25.5lm)	15	–	350mA	120	Yes	Tube <sup>(2)</sup>
ASMT-MG00-NLM00	Green	515-535nm <sup>(3)</sup>	L(73.0-95.0lm); M(95.0-124.0lm)	85	–	350mA	120	Yes	Tube <sup>(2)</sup>
ASMT-MA00-AHJ00	Amber	582-594.5nm <sup>(3)</sup>	H(33-43lm); J(43-56lm)	40lm	-	350mA	120	No	Tube <sup>(2)</sup>
ASMT-MR00-AHJ00	Red	620-635nm	H(33-43lm); J(43-56lm)	40	–	350mA	120	No	Tube <sup>(2)</sup>

### Notes

1. Narrow Color Temperature selections are available on request.
2. All above listed LEDs are also available in Reel packing.
3. Narrow color bin selections for blue, green and amber are available on request.

## 3W Moonstone™ High Power LEDs

Part Number	Color	Color Temperature (K)/Wavelength (nm)	Flux Bin (Luminous Flux/Radiometric Power @ 350mA)	Luminous Flux (lm) @ 350mA (typ)	Luminous Flux (lm) @ 700mA (typ)	Max. Current	Viewing Angle	Electrically Isolated Metal Slug	Packaging
ASMT-MW22-NNP00	Cool White	4000-10000K	N(110-125lm); P(125-140lm)	120	205	700mA	110	Yes	Tube
ASMT-MWE2-NNP00	Cool White Diffused	4000-10000K	N(110-125lm); P(125-140lm)	115	196	700mA	110	Yes	Tube
ASMT-MY22-NMP00	Warm White	2600-4000K	M(95-110lm); N(110-125lm);P(125-140lm)	100	170	700mA	110	Yes	Tube <sup>(2)</sup>
ASMT-MYE2-NMP00	Warm White Diffused	2600-4000K	M(95-110lm); N(110-125lm);P(125-140lm)	98	167	700mA	110	Yes	Tube <sup>(2)</sup>

### Notes

1. Narrow Color Temperature selections are available on request.
2. All above listed LEDs are also available in Reel packing.

## 3W RGB Tri-Color Moonstone™ High Power LED

Part Number	Color	Color Temperature (K)/ Wavelength (nm)	Flux Bin (Luminous Flux/Radiometric Power @ 350mA)	Luminous Flux (lm) @ 700mA (typ)	Max. Current	Viewing Angle	Electrically Isolated Metal Slug	Packaging
ASMT-MT00-00001	Red	620-635nm	H(33-43lm); J(43-56lm)	40	350mA	120	No	Tape and Reel
	Green	515 - 535nm <sup>(1)</sup>	L(73-95lm); M(95-124lm)	85	350mA	120	Yes	
	Blue	455 - 475nm <sup>(1)</sup>	D(11.5-15lm); E(15-19.5lm); F(19.5-25.5lm)	13	350mA	120	Yes	

### Notes

1. Narrow Color Temperature selections are available on request.



# High Brightness LEDs

## Package Dimensions

### Moonstone LED Emitters

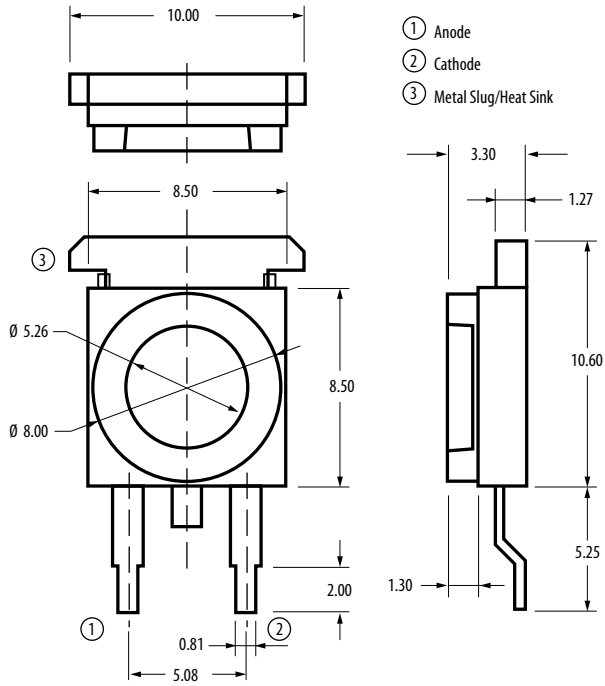

**Notes:**

1. All Dimensions in millimeters.
2. Tolerance is  $\pm 0.1$  mm unless otherwise specified.
3. Metal slug is connected to anode for electrically non-isolated option.

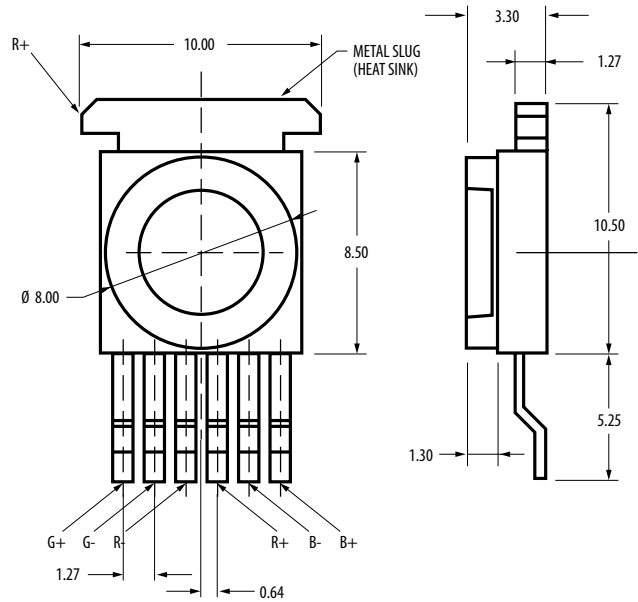

**Notes:**

1. All dimensions in millimeters.
2. Tolerance is  $\pm 0.1$  mm unless otherwise specified.
3. Metal slug is connected to the anode of Red.

# High Brightness LEDs



## Theialed 1W High Power LEDs

### Description

The ASMA-PxG1 1W High Power White LED is a high performance energy efficient device which can handle high thermal and high driving current. It has a thermal pad at the bottom of the package for improved heat dissipation. The thermal pad is electrically isolated, giving higher flexibility in system design.

The package is compatible with reflow soldering process. To facilitate easy pick & place assembly, the LEDs are packed in tape and reel. Every reel is shipped in single intensity and color bin, to provide close uniformity.

### Features

- Available in Cool White and Warm White
- Small footprint and low profile
- Energy efficient
- ANSI Bin
- Compatible with reflow soldering process
- High current operation
- Long operation life
- Wide viewing angle
- Silicone encapsulation
- MSL 2A products

### Applications

- Retail display lighting
- Under cabinet lighting
- Micro incandescent lamp replacement
- Indoor commercial and residential lighting
- Indoor decorative lighting

## Theialed 1W High Power LEDs

Part Number	Color	Color Temperature (K)	Luminous Flux, $\Phi_V$ (lm)			Test Current (mA)	Viewing Angle (°)	CRI
			Min.	Typ.	Max			
ASMA-PWG1-NNQ00	Cool White	8000 to 4000	89.2	103.0	118.4	350	120	85
ASMA-PWG1-NNQA0	Cool White	8000	89.2	103.0	118.4	350	120	85
ASMA-PWG1-NNQB0	Cool White	6500	89.2	103.0	118.4	350	120	85
ASMA-PWG1-NNQC0	Cool White	5700	89.2	103.0	118.4	350	120	85
ASMA-PWG1-NNQD0	Cool White	5000	89.2	103.0	118.4	350	120	85
ASMA-PWG1-NNPE0	Cool White	4500	89.2	100.0	107.7	350	120	85
ASMA-PWG1-NNPF0	Cool White	4000	89.2	100.0	107.7	350	120	85
ASMA-PYG1-NMP10	Warm White	3500 to 2700	81.2	93.0	107.7	350	120	88
ASMA-PYG1-NNPG0	Warm White	3500	89.2	100.0	107.7	350	120	88
ASMA-PYG1-NNPH0	Warm White	3000	89.2	93.0	107.7	350	120	88
ASMA-PYG1-NMNJ0	Warm White	2700	81.2	89.0	98	350	120	88

# High Brightness LEDs

## Theialed 1W High Power LEDs

### Part Numbering System

A	S	M	A	-	P	X <sub>1</sub>	G	1	-	N	X <sub>2</sub>	X <sub>3</sub>	X <sub>4</sub>	0
---	---	---	---	---	---	----------------	---	---	---	---	----------------	----------------	----------------	---

Code	Description	Option
X <sub>1</sub>	Color	W Cool White
		Y Warm White
X <sub>2</sub>	Minimum flux bin	M 81.2 - 89.2lm
X <sub>3</sub>	Maximum flux bin	N 89.2 - 98.0lm
		P 98.0 - 107.7lm
		Q 107.7 - 118.4lm
X <sub>4</sub>	Color bin	A 8000K (Sub bin: 1A, 1B, 1C, 1D)
		B 6500K (Sub bin: 2A, 2B, 2C, 2D)
		C 5700K (Sub bin: 3A, 3B, 3C, 3D)
		D 5000K (Sub bin: 4A, 4B, 4C, 4D)
		E 4500K (Sub bin: 5A, 5B, 5C, 5D)
		F 4000K (Sub bin: 6A, 6B, 6C, 6D)
		G 3500K (Sub bin: 7A, 7B, 7C, 7D)
		H 3000K (Sub bin: 8A, 8B, 8C, 8D)
		J 2700K (Sub bin: 9A, 9B, 9C, 9D)
		K 8000K & 6500K (Sub bin: 1A, 1B, 1C, 1D, 2A, 2B, 2C, 2D)
		L 6500K & 5700K (Sub bin: 2A, 2B, 2C, 2D, 3A, 3B, 3C, 3D)
		M 5700K & 5000K (Sub bin: 3A, 3B, 3C, 3D, 4A, 4B, 4C, 4D)
		N 5000K & 4500K (Sub bin: 4A, 4B, 4C, 4D, 5A, 5B, 5C, 5D)
		P 4500K & 4000K (Sub bin: 5A, 5B, 5C, 5D, 6A, 6B, 6C, 6D)
		Q 4000K & 3500K (Sub bin: 6A, 6B, 6C, 6D, 7A, 7B, 7C, 7D)
		R 3500K & 3000K (Sub bin: 7A, 7B, 7C, 7D, 8A, 8B, 8C, 8D)
		S 3000K & 2700K (Sub bin: 8A, 8B, 8C, 8D, 9A, 9B, 9C, 9D)
		0 8000K to 4000K (Sub bin: 1A, 1B, 1C, 1D, 2A, 2B, 2C, 2D, 3A, 3B, 3C, 3D, 4A, 4B, 4C, 4D, 5A, 5B, 5C, 5D, 6A, 6B, 6C, 6D)
		1 3500K to 2700K (Sub bin: 7A, 7B, 7C, 7D, 8A, 8B, 8C, 8D, 9A, 9B, 9C, 9D)

### Bin Information

#### Intensity Bins (CAT)

Bin ID	Luminous Flux (lm)	
	Min.	Max.
M	81.2	89.2
N	89.2	98.0
P	98.0	107.7
Q	107.7	118.4

Tolerance ±12%

#### Forward Voltage Bins (VF)

Bin ID	Forward voltage (V)	
	Min.	Max.
FA5	2.9	3.1
FA6	3.1	3.3
FA7	3.3	3.5

Tolerance ±0.1V

#### Example of bin information on label:

CAT: N flux bin N  
 BIN: 2B color sub-bin 2B  
 VF: FA6 Vf bin FA6

#### Example:

##### ASMA-PWG1-NNQA0

x1=W Cool White  
 x2=N minimum flux bin N  
 x3=Q maximum flux bin Q  
 x4=A 8000K with sub bins 1A,1B,1C,1D

### Chromaticity Diagram

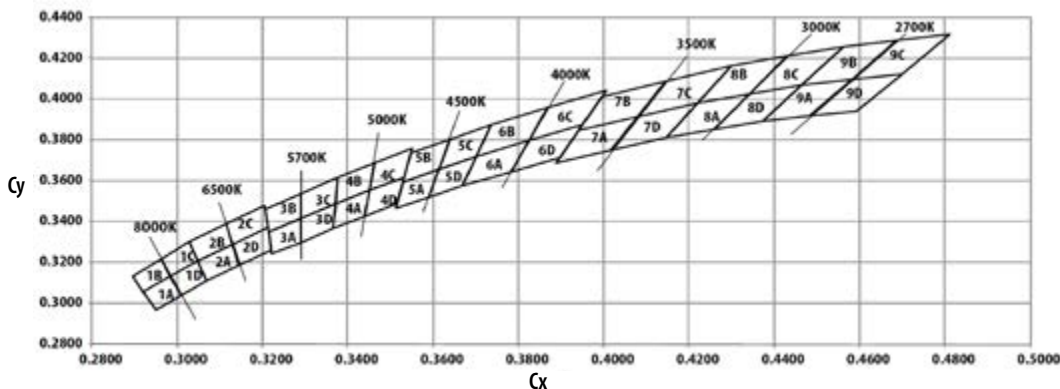

# High Brightness LEDs

## Color Bins (BIN)

CCT	Bin ID	Chromaticity coordinates	
		C <sub>x</sub>	C <sub>y</sub>
8000K	1A	0.2950	0.2970
		0.2920	0.3060
		0.2984	0.3133
		0.3009	0.3042
	1B	0.2920	0.3060
		0.2895	0.3135
		0.2962	0.3220
		0.2984	0.3133
	1C	0.2984	0.3133
		0.2962	0.3220
		0.3028	0.3304
		0.3048	0.3207
	1D	0.2984	0.3133
		0.3048	0.3207
		0.3068	0.3113
		0.3009	0.3042
6500K	2A	0.3048	0.3207
		0.3130	0.3290
		0.3144	0.3186
		0.3068	0.3113
	2B	0.3028	0.3304
		0.3115	0.3391
		0.3130	0.3290
		0.3048	0.3207
	2C	0.3115	0.3391
		0.3205	0.3481
		0.3213	0.3373
		0.3130	0.3290
	2D	0.3130	0.3290
		0.3213	0.3373
		0.3221	0.3261
		0.3144	0.3186
5700K	3A	0.3215	0.3350
		0.3290	0.3417
		0.3290	0.3300
		0.3222	0.3243
	3B	0.3207	0.3462
		0.3290	0.3538
		0.3290	0.3417
		0.3215	0.3350
	3C	0.3290	0.3538
		0.3376	0.3616
		0.3371	0.3490
		0.3290	0.3417
	3D	0.3290	0.3417
		0.3371	0.3490
		0.3366	0.3369
		0.3290	0.3300

Tolerance ±0.01

CCT	Bin ID	Chromaticity coordinates	
		C <sub>x</sub>	C <sub>y</sub>
5000K	4A	0.3371	0.3490
		0.3451	0.3554
		0.3440	0.3427
		0.3366	0.3369
	4B	0.3376	0.3616
		0.3463	0.3687
		0.3451	0.3554
		0.3371	0.3490
	4C	0.3463	0.3687
		0.3551	0.3760
		0.3533	0.3620
		0.3451	0.3554
	4D	0.3451	0.3554
		0.3533	0.3620
		0.3515	0.3487
		0.3440	0.3427
4500K	5A	0.3530	0.3597
		0.3615	0.3659
		0.3590	0.3521
		0.3512	0.3465
	5B	0.3548	0.3736
		0.3641	0.3804
		0.3615	0.3659
		0.3530	0.3597
	5C	0.3641	0.3804
		0.3736	0.3874
		0.3702	0.3722
		0.3615	0.3659
	5D	0.3615	0.3659
		0.3702	0.3722
		0.3670	0.3578
		0.3590	0.3521
4000K	6A	0.3670	0.3578
		0.3702	0.3722
		0.3825	0.3798
		0.3783	0.3646
	6B	0.3702	0.3722
		0.3736	0.3874
		0.3869	0.3958
		0.3825	0.3798
	6C	0.3825	0.3798
		0.3869	0.3958
		0.4006	0.4044
		0.3950	0.3875
	6D	0.3783	0.3646
		0.3825	0.3798
		0.3950	0.3875
		0.3898	0.3716

Tolerance ±0.01

CCT	Bin ID	Chromaticity coordinates	
		C <sub>x</sub>	C <sub>y</sub>
3500K	7A	0.3889	0.3690
		0.3941	0.3848
		0.4080	0.3916
		0.4017	0.3751
	7B	0.3941	0.3848
		0.3996	0.4015
		0.4146	0.4089
		0.4080	0.3916
	7C	0.4080	0.3916
		0.4146	0.4089
		0.4299	0.4165
		0.4221	0.3984
	7D	0.4017	0.3751
		0.4080	0.3916
		0.4221	0.3984
		0.4147	0.3814
3000K	7A	0.4147	0.3814
		0.4221	0.3984
		0.4342	0.4028
		0.4259	0.3853
	7B	0.4221	0.3984
		0.4299	0.4165
		0.4430	0.4212
		0.4342	0.4028
	7C	0.4342	0.4028
		0.4430	0.4212
		0.4562	0.4260
		0.4465	0.4071
	7D	0.4259	0.3853
		0.4342	0.4028
		0.4465	0.4071
		0.4373	0.3893
2700K	8A	0.4373	0.3893
		0.4465	0.4071
		0.4582	0.4099
		0.4483	0.3919
	8B	0.4465	0.4071
		0.4562	0.4260
		0.4687	0.4289
		0.4582	0.4099
	8C	0.4582	0.4099
		0.4687	0.4289
		0.4813	0.4319
		0.4700	0.4126
	8D	0.4483	0.3919
		0.4582	0.4099
		0.4700	0.4126
		0.4593	0.3944

Tolerance ±0.01

# High Brightness LEDs

## Package Dimensions

### Theialed 1W High Power LEDs

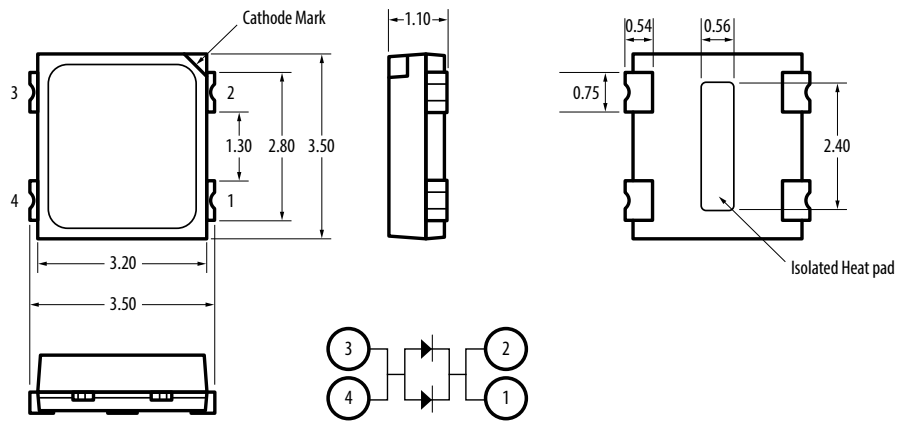

#### Notes:

1. All dimensions are in millimeter (mm).
2. Unless otherwise specified, tolerance is  $\pm 0.10$ mm.
3. Terminal finish = silver plating
4. Thermal pad is electrically isolated.



## Standard Through-hole Lamps

### Description

Avago Technologies offers four types of technology-based LEDs. GaP and AlGaAs based technologies are suitable for low to moderate light output requirements. AllnGaP and InGaN product offering are suitable for high brightness needs. Through-hole LEDs are offered in a variety of packages such as 3 mm, 5 mm, rectangular, bicolor, integrated resistors in standard and low current options.

These devices are molded from advanced optical grade epoxy, which provide superior high temperature performance and excellent moisture resistance.

Through-hole LEDs are suitable for all applications requiring backlighting and status indication. Consumer electronics and automotive interiors use LEDs to add value to their products. Low power consumption, high reliability and a broad range of colors and packages are just a few reasons why.

### Features and Benefits

- Excellent product quality and reliability
- Wide range of products
- Competitive pricing
- Wide operating temperature range
  - With minor electrical/optical changes
- Lower power consumption
  - High efficiency, low drive currents and low driving voltages required
- Thin, light weight and robust packaging
  - Excellent performance even under vibration and mechanical shock
- Different material technologies available in standard GaP LED lamps
  - Choice of colors (560 nm – 626 nm): Green, Yellow, Amber, Orange and Red
  - Red color using AlGaAs technology.
  - Five colors available with high luminous intensity in AllnGaP LED lamps
    - Amber (590 nm), Red (626 nm), Deep Red (635 nm), Orange (605 nm) and Red-Orange (615 nm)
  - Two colors available with high luminous intensity in InGaN LED lamps
    - Blue (470 nm) and Green (527 nm)
  - Several packaging options
    - Different sizes with a clear or diffused lens, several lead configurations and different spatial radiation patterns available in bulk, ammo-pack, right angle housing and tape and reel

### Typical Applications

- Consumer
  - Ovens, washers, etc.
  - Audio, hi-fi and electrical appliances
  - Gaming and vending machines
  - Electronic toys and games
- Industrial
  - Sensors
  - Instruments
  - Measurement equipment
- Automotive and Other
  - Automotive interior
  - Exercise equipment
  - Medical equipment
  - Front panel industrial equipment

# LED Indicators and Displays

## Standard Through-hole LED Lamps











Part Number	Color	Dominant Wavelength (nm)	Viewing Angle	Lens	Intensity		Vf Typ. (V)	Test Current (mA)
					Min. (mcd)	Typ. (mcd)		
<b>3 mm (T1) LED Lamps — Standard Current</b>								
HLMP-1301-G0002	GaP Red	626	60°	Tinted, Diffused	8.6	11	1.9	10
HLMP-1321	GaP Red	626	45°	Tinted, Non-diffused	8.6	30	1.9	10
HLMP-1340	GaP Red	626	45°	Micro-tinted, Non-diffused	35.2	55	1.9	20
HLMP-1401-E0000	GaP Yellow	585	60°	Tinted, Diffused	5.7	-	2	10
HLMP-1440	GaP Yellow	585	45°	Micro-tinted, Non-diffused	23.5	45	2.1	20
HLMP-1503	GaP Green	569	60°	Tinted, Diffused	4.2	8.5	2.1	10
HLMP-1521	GaP Green	569	45°	Tinted, Non-diffused	6.7	22	2.1	10
HLMP-1540	GaP Green	569	45°	Untinted, Non-diffused	27.3	45	2.2	20
HLMP-K101	AlGaAs Red	637	60°	Tinted, Diffused	22	45	1.8	20
HLMP-K105	AlGaAs Red	637	45°	Untinted, Non-diffused	35.2	65	1.8	20
HLMP-K640	GaP Green	560	45°	Untinted, Non-diffused	4.2	21	2.2	20
HLMP-Y601-J0000	AllnGaP Red	627	45	Untinted, Non-diffused	240	680	2.2	20
HLMP-Y651-G0000	AllnGaP Deep Red	638	45	Untinted, Non-diffused	140	300	2.2	20
HLMP-Y701-G0000	AllnGaP Amber	592	45	Untinted, Non-diffused	140	400	2.2	20
HLMP-Y802-F0000	AllnGaP Green	572	45	Tinted, Non-diffused	110	240	2.4	20
HLMP-Y901-J0000	AllnGaP Yellow Orange	605	45	Untinted, Non-diffused	240	680	2	20
HLMP-Y951-K0000	AllnGaP Red Orange	615	45	Untinted, Non-diffused	310	680	2	20
HLMP-KA45-E0000	InGaN Blue	464	50	Untinted, Non-diffused	85	480	3.5	20
<b>3 mm (T1) LED Lamps — Autoinsertable</b>								
HLMP-NG05	AllnGaP Red	626	45°	Micro-tinted, Non-diffused	90.2	435	1.90	20
HLMP-NG07	AllnGaP Red	626	60°	Micro-tinted, Non-diffused	90.2	435	1.90	20
HLMP-NL06	AllnGaP Amber	590	60°	Micro-tinted, Non-diffused	96.2	450	2.02	20
HLMP-NS30-J0000	InGaN Blue	470	30°	Untinted, Non-diffused	240	550	3.6	20
HLMP-NM31-R0000	InGaN Green	529	30°	Untinted, Non-diffused	1500	2800	3.3	20
<b>3 mm (T1) 5V, 12V Integrated Resistor LED Lamps</b>								
HLMP-1621 <sup>[1]</sup>	GaP Yellow	585	60°	Tinted, Diffused	2.2	8	8	—
HLMP-1640-B00A2 <sup>[2]</sup>	GaP Green	569	60°	Tinted, Diffused	1.6	8	8	—

Notes: 1. Operating Voltage = 12V. 2. Operating Voltage = 5V.

<b>5 mm (T1 3/4) LED Lamps — Standard Current</b>								
HLMP-3301	GaP Red	626	60°	Tinted, Diffused	5.4	7	1.9	10
HLMP-3401	GaP Yellow	585	60°	Tinted, Diffused	5.7	8	2	10
HLMP-3507	GaP Green	569	60°	Tinted, Diffused	4.2	5.2	2.1	10
HLMP-3950	GaP Green	569	24°	Micro-tinted, Non-diffused	111.7	265	2.2	20
HLMP-C008-U0000	AllnGaP Red	626	8°	Untinted, Non-diffused	2900	6000	1.9	20
HLMP-C025-P0000	AllnGaP Red	626	25°	Untinted, Non-diffused	500	1000	1.9	20
HLMP-C208-S0000	AllnGaP Amber	590	8°	Untinted, Non-diffused	2600	3000	1.9	20
HLMP-C225-O0000	AllnGaP Amber	590	25°	Untinted, Non-diffused	450	800	1.9	20
HLMP-C608-R0000	AllnGaP Red	635	8°	Untinted, Non-diffused	1000	2000	1.9	20
HLMP-C625-P0000	AllnGaP Red	635	25°	Untinted, Non-diffused	500	700	1.9	20
HLMP-DB25-B0000	GaN Blue	462	25°	Untinted, Non-diffused	40	100	4	20
HLMP-DM25-J0000	InGaN Green	527	25°	Untinted, Non-diffused	240	970	3.8	20
HLMP-DS25-F0000	InGaN Blue	470	25°	Untinted, Non-diffused	110	260	3.6	20
<b>5 mm (T1 3/4) LED Lamps — Low Current</b>								
HLMP-4700	GaP Red	626	50°	Tinted, Diffused	1.3	2.3	1.7	2
HLMP-4719	GaP Yellow	585	50°	Tinted, Diffused	0.9	2.1	1.8	2
HLMP-4740	GaP Green	569	50°	Tinted, Diffused	1	2.3	1.9	2
HLMP-D150	AlGaAs Red	637	65°	Tinted, Diffused	1.3	3	1.6	1

# LED Indicators and Displays

## Standard Through-hole Lamps

Part Number	Color	Dominant Wavelength (nm)	Viewing Angle	Lens	Intensity		Vf Typ. (V)	Test Current (mA)
					Min. (mcd)	Typ. (mcd)		
<b>2 mm x 5 mm Rectangular LED Lamps</b>								
HLMP-S201	 GaP Red	626	110°	Tinted, Diffused	3.4	7.5	1.9	20
HLMP-S301	 GaP Yellow	585	110°	Tinted, Diffused	2.2	4	2.1	20
HLMP-S501	 GaP Green	569	110°	Tinted, Diffused	4.2	8	2.2	20
<b>2mm x 5mm Bicolor Rectangular LED Lamps</b>								
HLMP-0800	 GaP Green	570	100°	Untinted, Diffused	2.6	–	2.2	20
	 GaP Red	626	100°	Untinted, Diffused	2.1	–	1.9	20
HLMP-0805	 GaP Green	570	100°	Untinted, Diffused	2.6	–	2.2	20
	 GaP Yellow	585	100°	Untinted, Diffused	1.4	–	2.1	20
<b>5 mm (T1 3/4) LED Lamps — Bicolor</b>								
HLMP-4000	 GaP Green	570	65°	Untinted, Diffused	4.2	–	2.2	10
	 GaP Red	626	65°	Untinted, Diffused	2.1	–	1.9	10
HLMP-4015	 GaP Green	570	65°	Untinted, Non-Diffused	20	–	2.2	20
	 GaP Yellow	585	65°	Untinted, Non-Diffused	20	–	2.6	20

## Intensity Bin Limits

Bin ID	Intensity (mcd)	
	Min.	Max.
<b>Red / Orange</b> 		
A	0.6	0.9
B	0.9	1.5
C	1.5	2.4
D	2.4	3.8
E	3.8	6.1
F	6.1	9.7
G	9.7	15.5
H	15.5	24.8
I	24.8	39.6
J	39.6	63.4
K	63.4	101.5
L	101.5	162.4
M	162.4	234.6
N	234.6	340.0
O	340	540
P	540	850
Q	850	1200
R	1200	1700
S	1700	2400
T	2400	3400
U	3400	4900
V	4900	7100
W	7100	10200
X	10200	14800
Y	14800	21400
Z	21400	30900

Tolerance: ±18%

Bin ID	Intensity (mcd)	
	Min.	Max.
<b>Yellow / Amber</b> 		
A	1.0	1.6
B	1.6	2.5
C	2.5	4.0
D	4.0	6.5
E	6.5	10.3
F	10.3	16.6
G	16.6	26.5
H	26.5	42.3
I	42.3	67.7
J	67.7	108.2
K	108.2	173.2
L	173.2	250.0
M	250	360
N	360	510
O	510	800
P	800	1250
Q	1250	1800
R	1800	2900
S	2900	4700
T	4700	7200
U	7200	11700
V	11700	18000
W	18000	27000

Tolerance: ±18%

Bin ID	Intensity (mcd)	
	Min.	Max.
<b>Green / Emerald Green *</b> 		
A	1.1	1.8
B	1.8	2.9
C	2.9	4.7
D	4.7	7.6
E	7.6	12.0
F	12.0	19.1
G	19.1	30.7
H	30.7	49.1
I	49.1	78.5
J	78.5	125.7
K	125.7	201.1
L	201.1	289.0
M	289	417
N	417	680
O	680	1100
P	1100	1800
Q	1800	2700
R	2700	4300
S	4300	6800
T	6800	10800
U	10800	16000
V	16000	25000
W	25000	40000

\* Except InGaN Green

Tolerance: ±18%





Bin ID	Intensity (mcd)	
	Min.	Max.
<b>InGaN Green / Blue</b> 		
A	30	40
B	40	50
C	50	65
D	65	85
E	85	110
F	110	140
G	140	180
H	180	240
J	240	310
K	310	400
L	400	520
M	520	680
N	680	880
P	880	1150
Q	1150	1500
R	1500	1900
S	1900	2500
T	2500	3200
U	3200	4200
V	4200	5500
W	5500	7200
X	7200	9300
Y	9300	12000

Tolerance: ±15%





# LED Indicators and Displays

## Color Bin Limits

Bin ID	Intensity (mcd)	
	Min.	Max.
<b>Orange</b> 		
2	599.0	602.5
3	601.5	605.0
4	603.8	608.2
5	606.8	611.2
<b>Yellow</b> 		
1	582.0	584.5
3	584.5	587.0
2	587.0	589.5
4	589.5	592.0
5	592.0	593.0
<b>Amber</b> 		
3	584.5	587.0
2	587.0	589.5
4	589.5	592.0
6	592.0	594.5
7	594.5	597.0
<b>Emerald Green</b> 		
1	582.0	584.5
3	584.5	587.0
2	587.0	589.5
4	589.5	592.0
5	592.0	593.0

Tolerance: ±0.5nm

Bin ID	Intensity (mcd)	
	Min.	Max.
<b>Green (except InGaN Green)</b> 		
6	561.5	564.5
5	564.5	567.5
4	567.5	570.5
3	570.5	573.5
2	573.5	576.5
<b>Yellow</b> 		
1	520.0	524.0
3	524.0	528.0
2	528.0	532.0
4	532.0	536.0
5	536.0	540.0
<b>Blue</b> 		
1	460.0	464.0
2	464.0	468.0
3	468.0	472.0
4	472.0	476.0
5	476.0	480.0

Tolerance: ±0.5nm

# LED Indicators and Displays

## Package Dimensions

### 3 mm (T1) LED Lamps – Autoinsertable Package

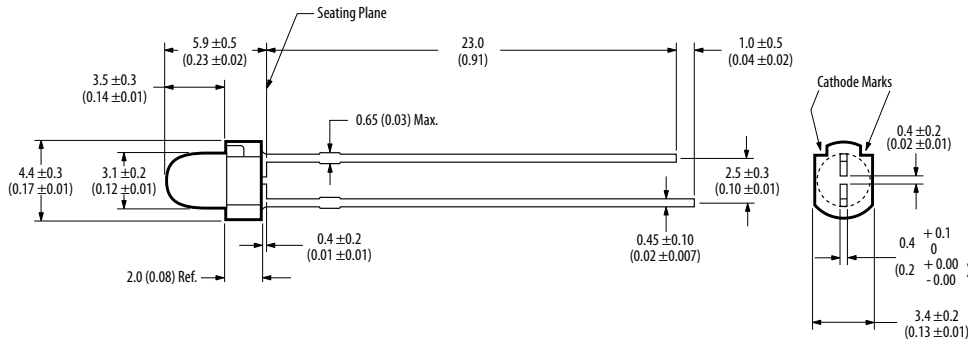

### 3 mm (T1) LED Lamps Package

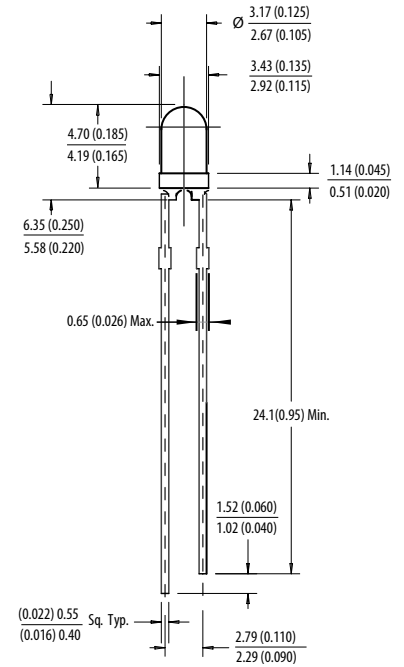

### 3 mm (T1) AlInGaP LED Lamps Package

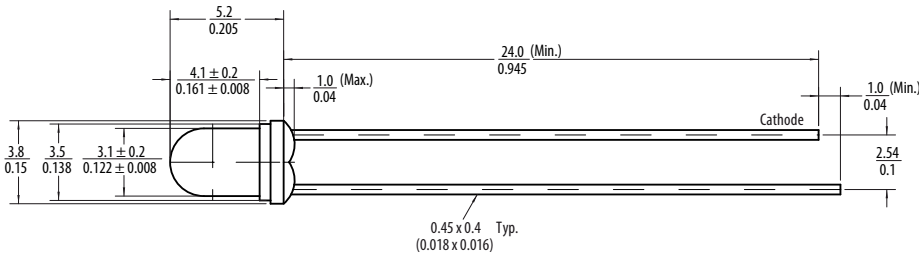

#### Notes:

1. All dimensions in millimeters (inches).
2. Leads are mild steel. Solder coated.
3. Epoxy Meniscus of 0.8 mm (0.03 in.) maximum may extend to the leads.

### 5 mm (T1 3/4) LED Lamps Package

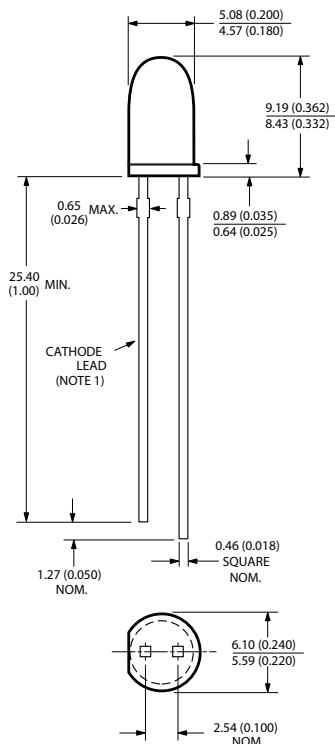

### 5 mm (T1-3/4) LED Lamps - Bicolor

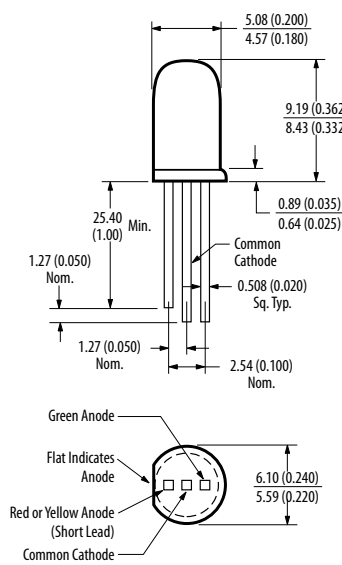

### 2 x 5 mm Rectangular LED Lamps Package

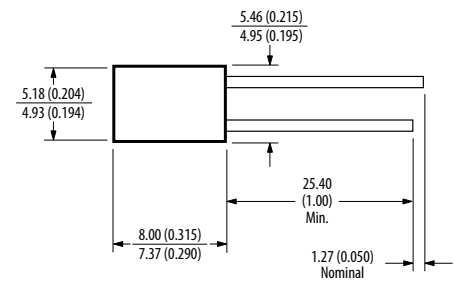



## Subminiature Lamps

### Description

Avago Technologies' Subminiature Lamps are designed for modern printed circuit (PC) boards, replacing through-hole mounted components for many traditional functions with smaller components, sized for closer placement.

Subminiature Lamp components are available in several lead configurations and can be used for top mount, reverse mount, and through-hole applications. The lead configurations are 'Gull Wing'–011 option, 'Yoke Bend'–021 option and 'Z Bend'–031 option. A variety of packages are available, such as flat top, dome and rectangular in standard or low current options.

Besides this, PCB based subminiature lamps are available as well. These lamps come in un-tinted, non-diffused package to cater for various product themes and ease handling applications. The small size, narrow footprint and high brightness make these LEDs excellent for backlighting, status indication and panel illumination applications.

### Features and Benefits

- Excellent product quality
- Wide range of product offering
- Competitive pricing
- Can be used with surface mount or through-hole applications
- High reliability
  - No replacement for life of equipment
- Wide operating temperature range
  - Minor electrical/optical changes
- Lower power consumption
  - High efficiency, low drive currents required, low driving voltages
- Thin, light-weight and robust packaging
  - Excellent performance even under vibration and mechanical shock
- Different thin material technologies available
  - Several colors available in GaP
  - Choice of colors (560 – 626 nm): Green, Yellow, Amber, Orange, Red and Deep Red
  - Three colors available in AlnGaP
    - Amber (590 nm), Red (626 nm) and Orange (605 nm)
  - Two colors available in InGaN
    - Blue (472 nm), Green (526 nm)
- Several lead configuration options
  - Gull-wing, Yoke-bend and Z-bend
- Several Packaging options
  - Different sizes and spatial radiation patterns available in bulk, right angle housing, and tape and reel

### Typical Applications

- Industrial and Communication
  - Front panel and symbol indicator
  - Keypad and push button backlighting
- Consumer
  - CD player, hi-fi audio and electrical appliances
  - Keypad and push button backlighting
- Automotive
  - Dashboard panel and symbol backlighting
  - Car radio indicators

# LED Indicators and Displays

## Domed Subminiature Lamps

Part Number	Color	Dominant Wavelength (nm)	Viewing Angle	Lens	Intensity		Vf Typ. (V)	Test Current (mA)
					Min. (mcd)	Typ. (mcd)		
HLMP-Q106-R00xx	TS AlGaAs Red	644	15°	Untinted, Non-diffused	100	400	1.9	20
HLMA-QG00-S00xx	AllnGaP Red	626	15°	Untinted, Non-diffused	160	500	1.9	20
HLMT-QG00-T00xx	AllnGaP Red	622	15°	Untinted, Non-diffused	250	1000	2	20
HLMP-6300-F00xx	GaP Red	626	90°	Tinted, Diffused	1	10	1.8	10
HLMA-QH00-S00xx	AllnGaP Red-Orange	615	15°	Untinted, Non-diffused	160	500	1.9	20
HLMT-QH00-T00xx	AllnGaP Red-Orange	615	15°	Untinted, Non-diffused	250	500	2	20
HLMA-QJ00-S00xx	AllnGaP Orange	605	15°	Untinted, Non-diffused	160	500	1.9	20
HLMA-QL00-S00xx	AllnGaP Amber	590	15°	Untinted, Non-diffused	160	500	1.9	20
HLMT-QL00-Txxxx	AllnGaP Amber	590	15°	Untinted, Non-diffused	250	–	2	20
HLMP-6400-F00xx	GaP Yellow	585	90°	Tinted, Diffused	1	9	2	10
HLMP-6500-F00xx	GaP Green	569	90°	Tinted, Diffused	1	7	2.1	10
HLMP-6505-L00xx	GaP Green	569	28°	Untinted, Non-diffused	10	40	2.1	10
HLMP-QB00-S00xx	InGaN Blue	468	20°	Untinted, Non-diffused	–	160	290	3.7
HLMP-QM00-S00xx	InGaN Green	525	20°	Untinted, Non-diffused	–	160	690	3.7
<b>Domed Subminiature Lamps — Low Current</b>								
HLMP-Q150-F00xx	AlGaAs Red	637	90°	Tinted, Diffused	1	1.8	1.8	1.6
HLMP-7000-D00xx	GaP Red	626	90°	Tinted, Diffused	0.4	1	1.4	1.8
HLMP-7019-D00xx	GaP Yellow	585	90°	Tinted, Diffused	0.4	0.6	1.6	2
HLMP-7040-D00xx	GaP Green	569	90°	Tinted, Diffused	0.4	0.6	1.4	2.1

## Domed Subminiature Lamps — Resistor

Part Number	Color	Dominant Wavelength (nm)	Viewing Angle	Lens	Intensity		Vf Typ. (V)	Test Current (mA)
					Min. (mcd)	Typ. (mcd)		
HLMP-6600-G00xx	GaP Red	626	90°	Tinted, Diffused	1.6	5	9.6	5
HLMP-6620-F00xx	GaP Red	626	90°	Tinted, Diffused	1	2	3.5	5
HLMP-6720-F00xx	GaP Yellow	585	90°	Tinted, Diffused	0.9	2	3.5	5
HLMP-6800-G00xx	GaP Green	569	90°	Tinted, Diffused	1.6	5	9.6	5
HLMP-6820-F00xx	GaP Green	569	90°	Tinted, Diffused	1	2	3.5	5
<b>Flat Top Subminiature Lamps</b>								
HLMP-P105-L00xx	AlGaAs Red	637	125°	Untinted, Non-diffused	10	30	1.8	20
HLMA-PG00-N00xx	AllnGaP Red	626	125°	Untinted, Non-diffused	25	75	1.9	20
HLMT-PG00-P00xx	AllnGaP Red	622	125°	Untinted, Non-diffused	40	150	2	20
HLMP-P205-F00xx	GaP Red	626	125°	Untinted, Non-diffused	1	8	1.8	10
HLMT-PH00-P00xx	AllnGaP Red Orange	615	125°	Untinted, Non-diffused	40	120	2	20
HLMA-PJ00-N00xx	AllnGaP Orange	605	125°	Untinted, Non-diffused	25	75	2	20
HLMA-PL00-N00xx	AllnGaP Amber	590	125°	Untinted, Non-diffused	25	75	1.9	20
HLMT-PL00-P0Wxx	AllnGaP Amber	590	125°	Untinted, Non-diffused	40	150	2.4	20
HLMP-P505-G00xx	GaP Green	569	125°	Untinted, Non-diffused	1.6	6.5	2.1	10
HLMP-P605-F00xx	GaP Emerald Green	560	125°	Untinted, Non-diffused	1	1.5	2.2	10
HLMP-PB00-N00xx	InGaN Blue	468	90°	Untinted, Non-diffused	25	60	3.7	20
HLMP-PM00-N00xx	InGaN Green	528	90°	Untinted, Non-diffused	25	200	3.7	20
<b>PCB Based Subminiature Lamps</b>								
ASMT-BA20-AS000	AllnGaP Amber	590	15°	Untinted, Non-diffused	180	750	2.0	20
ASMT-BG20-AS000	AllnGaP Green	569	15°	Untinted, Non-diffused	180	650	2.0	20
ASMT-BR20-AS000	AllnGaP Red	626	15°	Untinted, Non-diffused	180	650	2.0	20
ASMT-BB20-NS000	InGaN Blue	468	15°	Untinted, Non-diffused	180	650	3.2	20

Note: "xx" at the end of the part number refers to the mechanical option number. Refer to table on the next page.

# LED Indicators and Displays

Subminiature Lamps are also available in the following options:





Mechanical Option Number	Description
10	Right Angle
11	Tape and Reel, 1500 lamps per reel
12	Gull Wing, Bulk Packaging
21	Yoke Lead, Tape and Reel, 1500 lamps per reel
22	Yoke Lead, Bulk Packaging
31	Z-Bend, Tape and Reel, 1500 lamps per reel
32	Z-Bend, Bulk Packaging



## Intensity Bin Limits

Bin ID	Intensity (mcd)	
	Min.	Max.
A	0.10	0.20
B	0.16	0.32
C	0.25	0.50
D	0.40	0.80
E	0.63	1.25
F	1.0	2.0
G	1.6	3.2
H	2.5	5.0
J	4.0	8.0
K	6.3	12.5
L	10	20
M	16	32
N	25	50
P	40	80.0
Q	63	125
R	100	200
S	160	320
T	250	500
U	400	800
V	630	1250
W	1000	2000
X	1600	3200
Y	2500	5000

Tolerance: ±18%

## Color Bin Limits

Bin ID	Intensity (mcd)	
	Min.	Max.
<b>Red Orange</b> 		
1	617.5	625.0
2	621.0	628.5
3	624.5	632.0
<b>Orange</b> 		
1	596.5	600.0
2	599.0	602.5
3	601.5	604.0
4	603.8	608.2
5	606.8	611.2
6	609.8	614.2
7	612.8	617.2
8	615.8	620.2
<b>Yellow</b> 		
1	581.5	585.0
3	584.0	587.5
2	586.5	590.0
4	589.0	592.5
5	591.5	593.5
6	591.5	595.0
7	594.0	597.5
<b>Green (except InGaN Green)</b> 		
4	567	571
3	570	574
2	573	577
<b>Emerald Green</b> 		
9	552.0	556.0
8	555.0	559.0
7	558.0	562.0
6	561.0	565.0

Bin ID	Intensity (mcd)	
	Min.	Max.
<b>InGaN Green</b> 		
0	Full distribution	
1	520.0	530.0
2	530.0	540.0
3	520.0	525.5
4	525.0	530.0
5	530.0	535.0
6	535.0	540.0
<b>InGaN Blue</b> 		
0	Full distribution	
1	460.0	464.0
2	464.0	468.0
3	468.0	472.0
4	472.0	476.0
5	476.0	480.0
6	480.0	484.0

Tolerance = ±1nm

# LED Indicators and Displays

## Surface Mount Subminiature LED Lamps Package Dimensions

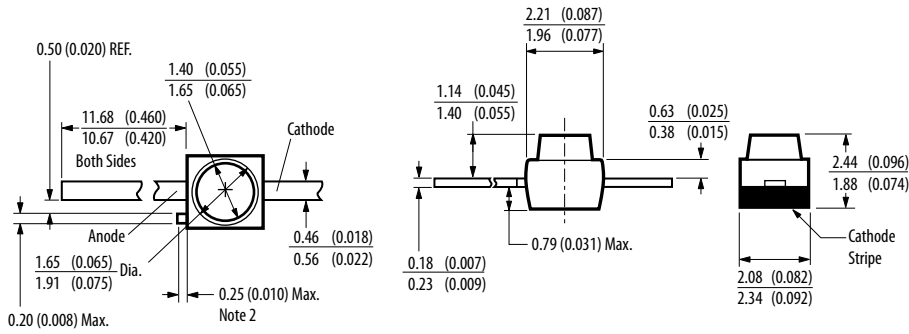

## Flat Top Subminiature Lamps

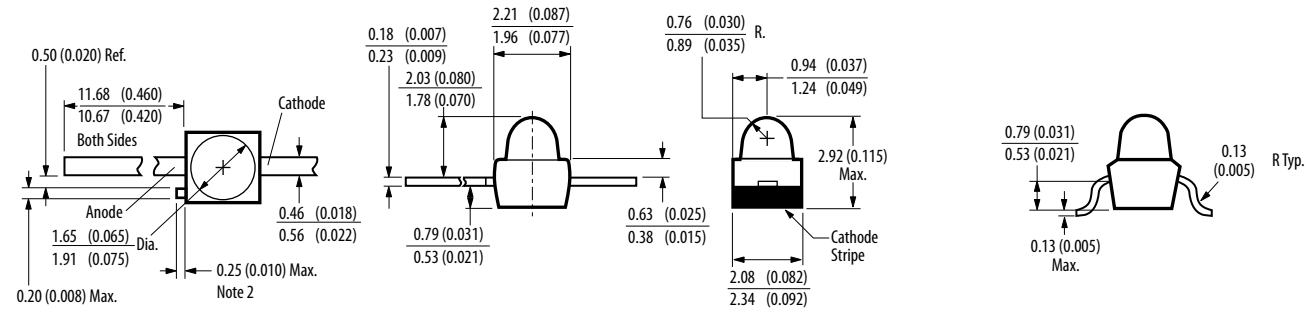

### Notes:

1. All dimensions in millimeters (inches).
2. Protruding support tab is connected to Cathode Lead.

## Option 011, 012

## Domed Subminiature Lamps

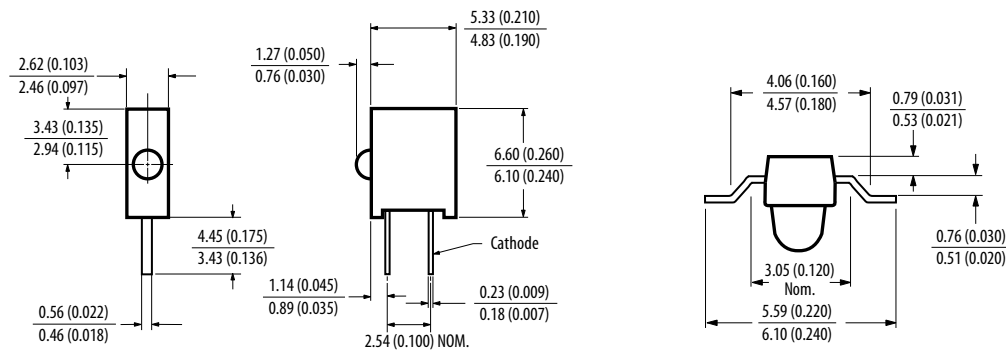

## Option 010

## Option 031, 032

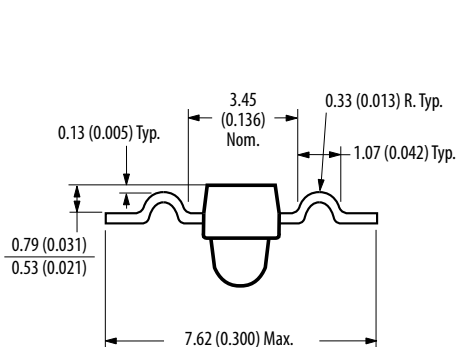

## Option 021, 022

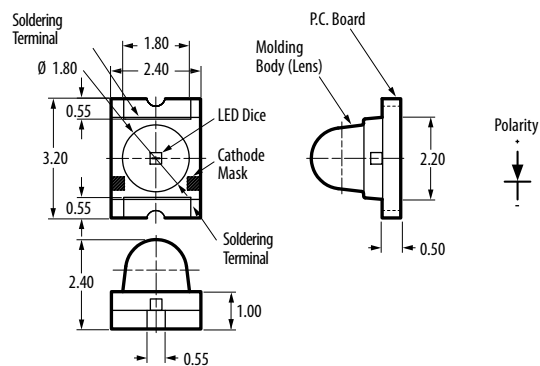

## PCB Based Subminiature Lamps



## Surface Mount ChipLEDs

### Description

For applications that require small size, high efficiency and low power consumption, Avago Technologies offers an extensive range of high quality ChipLEDs to meet demands for virtually any surface mount lighting requirement.

Avago Technologies' ChipLEDs are available in standard and high-brightness colors, using Avago Technologies' proven AlGaAs, AlInGaP and InGaN processes to give you the broadest range of colors from a single supplier.

Avago's ChipLEDs use the industry standard footprint, with top-mount, reverse-mount and right-angle-mount packaging options. They also have the lowest profile in the industry and are positioned to support high volume, cost-effective solutions.

ChipLED products are used in a variety of applications including LCD and push button backlighting for cellular phones, white goods and appliances, industrial measurement and control systems, and for symbol lighting and status indication in computer peripherals and consumer goods.

Low power consumption, small size and easy assembly make the ChipLED ideal for backlighting handsets as well as backlighting industrial displays.

### Features and Benefits

- Small size
  - Saves PC board space
- Wide viewing angle
  - Well-suited for backlighting applications
- Intensity and color bin uniformity
  - Can be closely mounted without any intensity variations
- Available in multiple colors
  - Amber, Red, AlGaAs Red, Green, Orange, Yellow, InGaN Blue, InGaN Green, bicolor and tricolor combinations
- Variety of packages and mounting options
  - Top, reverse and right angle auto mountable
- Industry standard footprint
  - No change in existing board layout
- High volume, high reliability
  - Cost-effective solution

### Typical Applications

- Telecommunications
  - Keypad and LCD backlighting for mobile phones, pagers and cordless phones
- Industrial
  - Status and symbol indicator
  - Keypad and LCD backlighting
- Consumer
  - White goods and appliances
- Computer Peripherals
  - Status indicator
- Indoor Full/Mono color sign
- Automotive interior

# LED Indicators and Displays

## Surface Mount ChipLEDs

Part Number	Color	Dominant Wavelength (nm)	Viewing Angle	Lens	Intensity		Vf Typ. (V)	Test Current (mA)
					Min. (mcd)	Typ. (mcd)		
Top Mount 1206 Industrial Footprint with 1.1 mm Height (C150)								
<b>3.2 x 1.6 x 1.1 mm (L x W x H)</b>								
HSMH-C150	AS AlGaAs Red	639	170°	Diffused	7.2	17	1.8	20
HSMD-C150	GaP Orange	604	170°	Diffused	2.8	8	2.2	20
HSMG-C150	GaP Green	572	170°	Diffused	4.5	15	2.2	20
HSMS-C150	GaP Red	626	170°	Diffused	2.8	10	2.1	20
HSMY-C150	GaP Yellow	586	170°	Diffused	2.8	8	2.1	20
HSMQ-C150	InGaN Green	527	140°	Diffused	45	145	3.4	20
HSMR-C150	InGaN Blue	473	140°	Diffused	18	55	3.4	20
HSME-C150	AS AllnGaP Green	572	170°	Diffused	18	50	2.1	20

Quantity: 3,000 per 7 inch reel

Top Mount 0805 Industrial Footprint with 0.8 mm Height (C170)								
<b>2.0 x 1.25 x 0.8 mm (L x W x H)</b>								
HSMH-C170	AS AlGaAs Red	639	170°	Diffused	7.2	17	1.8	20
HSMD-C170	GaP Orange	604	170°	Diffused	2.8	8	2.2	20
HSMG-C170	GaP Green	572	170°	Diffused	4.5	15	2.2	20
HSMS-C170	GaP Red	626	170°	Diffused	2.8	10	2.1	20
HSMY-C170	GaP Yellow	586	170°	Diffused	2.8	8	2.1	20
HSMA-C170	AS AllnGaP Amber	592	170°	Diffused	28.5	90	1.9	20
HSMC-C170	AS AllnGaP Red	626	170°	Diffused	28.5	90	1.9	20
HSML-C170	AS AllnGaP Orange	605	170°	Diffused	28.5	90	1.9	20
HSMZ-C170	AS AllnGaP Red	631	170°	Diffused	45	165	2.2	20
HSMM-C170	InGaN Green	525	170°	Diffused	45	120	3.3	20
HSMN-C170	InGaN Blue	470	170°	Diffused	11.2	35	3.3	20
HSMQ-C170	InGaN Green	527	140°	Diffused	45	145	3.4	20
HSMR-C170	InGaN Blue	473	140°	Diffused	18	55	3.4	20
HSME-C170	AS AllnGaP Green	572	170°	Diffused	18	50	2.1	20

Quantity: 4,000 per 7 inch reel

Top Mount 0603 Industrial Footprint with 0.8 mm Height (C190)								
<b>1.6 x 0.8 x 0.8 mm (L x W x H)</b>								
HSMH-C190	AS AlGaAs Red	639	170°	Diffused	7.2	17	1.8	20
HSMD-C190	GaP Orange	604	170°	Diffused	2.8	8	2.2	20
HSMG-C190	GaP Green	572	170°	Diffused	4.5	5	2.2	20
HSMS-C190	GaP Red	626	170°	Diffused	2.8	10	2.1	20
HSMY-C190	GaP Yellow	586	170°	Diffused	2.8	8	2.1	20
HSMA-C190	AS AllnGaP Amber	592	170°	Diffused	28.5	90	1.9	20
HSMC-C190	AS AllnGaP Red	626	170°	Diffused	28.5	90	1.9	20
HSML-C190	AS AllnGaP Orange	605	170°	Diffused	28.5	90	1.9	20
HSMZ-C190	AS AllnGaP Red	631	170°	Diffused	45	165	2.2	20
HSMM-C190	InGaN Green	525	170°	Diffused	45	120	3.3	20
HSMN-C190	InGaN Blue	470	170°	Diffused	11.2	35	3.3	20
HSMQ-C190	InGaN Green	527	140°	Diffused	45	145	3.4	20
HSMR-C190	InGaN Blue	473	140°	Diffused	18	55	3.4	20
HSME-C190	AS AllnGaP Green	572	170°	Diffused	18	50	2.1	20

Quantity: 4,000 per 7 inch reel



# LED Indicators and Displays

## Surface Mount ChipLEDs

Part Number	Color	Dominant Wavelength (nm)	Viewing Angle	Lens	Intensity		Vf Typ. (V)	Test Current (mA)
					Min. (mcd)	Typ. (mcd)		
Top Mount 0603 Industrial Footprint with 0.6 mm Height (C191)								
<b>1.6 x 0.8 x 0.6 mm (L x W x H)</b>								
HSMH-C191	AS AlGaAs Red	639	170°	Diffused	7.2	17	1.8	20
HSMD-C191	GaP Orange	604	170°	Diffused	2.8	8	2.2	20
HSMG-C191	GaP Green	572	170°	Diffused	4.5	5	2.2	20
HSMS-C191	GaP Red	626	170°	Diffused	2.8	10	2.1	20
HSMY-C191	GaP Yellow	586	170°	Diffused	2.8	8	2.1	20
HSMA-C191	AS AllnGaP Amber	592	170°	Diffused	28.5	90	1.9	20i
HSMC-C191	AS AllnGaP Red	626	170°	Diffused	28.5	90	1.9	20
HSML-C191	AS AllnGaP Orange	605	170°	Diffused	28.5	90	1.9	20
HSMN-C191	InGaN Blue	470	170°	Diffused	11.2	35	3.3	20
HSMQ-C191	InGaN Green	527	140°	Diffused	45	145	3.4	20
HSMR-C191	InGaN Blue	473	140°	Diffused	18	55	3.4	20
HSME-C191	AS AllnGaP Green	572	170°	Diffused	18	50	2.1	20

Quantity: 4,000 per 7 inch reel

Top Mount 0805 Industrial Footprint with 0.4 mm Height (C177)								
<b>2.0 x 1.25 x 0.4 mm (L x W x H)</b>								
HSMD-C177	GaP Orange	604	130°	Diffused	2.8	8	2.2	20
HSMG-C177	GaP Green	572	130°	Diffused	4.5	5	2.2	20
HSMS-C177	GaP Red	626	130°	Diffused	2.8	10	2.1	20
HSMA-C177	AS AllnGaP Amber	592	130°	Diffused	28.5	90	1.9	20
HSMC-C177	AS AllnGaP Red	626	130°	Diffused	28.5	90	1.9	20
HSML-C177	AS AllnGaP Orange	605	130°	Diffused	28.5	90	1.9	20
HSME-C177	AS AllnGaP Green	572	130°	Diffused	18	50	2.1	20

Quantity: 4,000 per 7 inch reel

Top Mount 0603 Industrial Footprint with 0.4 mm Height (C197)								
<b>1.6 x 0.8 x 0.4 mm (L x W x H)</b>								
HSMD-C197	GaP Orange	604	130°	Diffused	2.8	8	2.2	20
HSMG-C197	GaP Green	572	130°	Diffused	4.5	5	2.2	20
HSMS-C197	GaP Red	626	130°	Diffused	2.8	10	2.1	20
HSMY-C197	GaP Yellow	586	130°	Diffused	2.8	8	2.1	20
HSMA-C197	AS AllnGaP Amber	592	130°	Diffused	28.5	90	1.9	20
HSMC-C197	AS AllnGaP Red	626	130°	Diffused	28.5	90	1.9	20
HSML-C197	AS AllnGaP Orange	605	130°	Diffused	28.5	90	1.9	20
HSME-C197	AS AllnGaP Green	572	130°	Diffused	18	50	2.1	20

Quantity: 4,000 per 7 inch reel

Top Mount 0402 Industrial Footprint with 0.4 mm Height (C280)								
<b>1.0 x 0.5 x 0.4 mm (L x W x H)</b>								
HSMA-C280	AS AllnGaP Amber	592	130°	Diffused	28.5	90	1.9	20
HSMC-C280	AS AllnGaP Red	626	130°	Diffused	28.5	90	1.9	20
HSMG-C280	GaP Green	572	130°	Diffused	4.5	15	2.2	20
HSMS-C280	GaP Red	626	130°	Diffused	2.8	10	2.1	20
HSMY-C280	GaP Yellow	586	130°	Diffused	2.8	8	2.1	20
HSME-C280	AllnGaP green	572	130	Diffused	28.5	45	1.9	20
HSMQ-C280	InGaN green	522	130	Diffused	112.5	222.8	3.4	20
HSMR-C280	InGaN blue	465	130	Diffused	28.5	80	3.2	20

Quantity: 4,000 per 7 inch reel

# LED Indicators and Displays

## Surface Mount ChipLEDs

Part Number	Color	Dominant Wavelength (nm)	Viewing Angle	Lens	Intensity		Vf Typ. (V)	Test Current (mA)
					Min. (mcd)	Typ. (mcd)		
<b>Top Mount 0603 Industrial Footprint with 0.35 mm Height (C130)</b>								
<b>1.6 x 0.8 x 0.35 mm (L x W x H)</b>								
HSMA-C130	AllnGaP Amber	592	110°	Diffused	28.5	87	2	20
HSMC-C130	AllnGaP Red	626	110°	Diffused	28.5	131	1.9	20
HSME-C130	AllnGaP Green	572	110°	Diffused	18	54	1.9	20
HSML-C130	AllnGaP Orange	605	110°	Diffused	28.5	139	1.9	20
HSMR-C130	InGaN Blue	473	145°	Diffused	18	55	3.4	20
HSMQ-C130	InGaN green	527	120	Diffused	285	350	3.4	20

Quantity: 4,000 per 7 inch reel

<b>Right Angle 1 mm Height (C110)</b>								
<b>3.2 x 1.5 x 1.0 mm (L x W x H)</b>								
HSMH-C110	AS AlGaAs Red	639	130°	Non-diffused	7.2	17	1.8	20
HSMD-C110	GaP Orange	604	130°	Non-diffused	2.8	8	2.2	20
HSMG-C110	GaP Green	572	130°	Non-diffused	4.5	15	2.2	20
HSMS-C110	GaP Red	626	130°	Non-diffused	2.8	10	2.1	20
HSMY-C110	GaP Yellow	586	130°	Non-diffused	2.8	8	2.1	20
HSMA-C110	AS AllnGaP Amber	592	130°	Non-diffused	28.5	95	1.9	20
HSMC-C110	AS AllnGaP Red	626	130°	Non-diffused	28.5	95	1.9	20
HSML-C110	AS AllnGaP Orange	605	130°	Non-diffused	28.5	95	1.9	20
HSMZ-C110	AS AllnGaP Red	631	130°	Non-diffused	45	170	2.2	20
HSMM-C110	InGaN Green	525	130°	Non-diffused	45	126	3.3	20
HSMN-C110	InGaN Blue	470	130°	Non-diffused	11.2	39	3.3	20
HSMQ-C110	InGaN Green	527	130°	Non-diffused	45	150	3.4	20
HSMR-C110	InGaN Blue	473	130°	Non-diffused	18	60	3.4	20
HSME-C110	AS AllnGaP Green	572	130°	Non-diffused	18	52	2.1	20

Quantity: 3,000 per 7 inch reel

<b>Top Mount 0603 Industrial Footprint with 0.2mm height (CB20)</b>								
<b>1.6 x 0.8 x 0.2 mm (L x W x H)</b>								
	InGaN Blue	473	120	Diffused	11.2	25	2.85	5

Quantity: 3,000 per 7 inch reel

# LED Indicators and Displays

## Surface Mount ChipLEDs

Part Number	Color	Dominant Wavelength (nm)	Viewing Angle	Lens	Intensity		Vf Typ. (V)	Test Current (mA)
					Min. (mcd)	Typ. (mcd)		
<b>Right Angle 0.6 mm Height (C120)</b>								
<b>1.6 x 1.0 x 0.6 mm (L x W x H)</b>								
HSMH-C120	AS AlGaAs	639	155°	Non-diffused	7.2	17	1.8	20
HSMD-C120	GaP Orange	604	155°	Non-diffused	2.8	8	2.2	20
HSMG-C120	GaP Green	572	155°	Non-diffused	4.5	15	2.2	20
HSMA-C120	AS AllnGaP Amber	592	155°	Non-diffused	28.5	90	1.9	20
HSMC-C120	AS AllnGaP Red	626	155°	Non-diffused	28.5	90	1.9	20
HSML-C120	AS AllnGaP Orange	605	155°	Non-diffused	28.5	90	1.9	20
HSMM-C120	InGaN Green	525	155°	Non-diffused	45	120	3.4	20
HSMN-C120	InGaN Blue	470	155°	Non-diffused	11.2	30	3.4	20
HSMQ-C120	InGaN Green	527	155°	Non-diffused	45	145	3.4	20
HSMR-C120	InGaN Blue	473	155°	Non-diffused	18	55	3.4	20
HSME-C120	AS AllnGaP Green	572	155°	Non-diffused	18	52	2.1	20

Quantity: 4,000 per 7 inch reel

<b>Right Angle 0.4 mm Height (Cx00)</b>								
<b>1.6 x 1.0 x 0.4 mm (L x W x H)</b>								
ASMT-CA00	AllnGaP Amber	592	150°	Non-diffused	28.5	90	1.9	20
ASMT-CR00	AllnGaP Red	626	150	Non-diffused	28.5	90	1.9	20
ASMT-CG00	InGaN Green	527	150	Non-diffused	45	225	3.1	20
ASMT-CB00	InGaN Blue	473	150°	Non-diffused	7.2	18	2.85	5
ASMT-CW00	InGaN White	Chromaticity Coordinates Bin A1-D2	170°	Diffused	18	35	2.85	5

Quantity: 4,000 per 7 inch reel

<b>Reverse Mount (C265)</b>								
<b>3.4 x 1.25 x 1.1 mm (L x W x H)</b>								
HSMA-C265	AS AllnGaP Amber	592	150°	Non-diffused	28.5	75	1.9	20
HSMC-C265	AS AllnGaP Red	626	150°	Non-diffused	28.5	75	1.9	20
HSME-C265	AS AllnGaP Green	572	170°	Non-diffused	18	50	2.1	20
HSML-C265	AS AllnGaP Orange	605	150°	Non-diffused	28.5	75	1.9	20
HSMG-C265	GaP Green	572	170°	Non-diffused	4.5	15	2.2	20
HSMH-C265	AS AlGaAs Red	639	170°	Non-diffused	7.2	17	1.8	20
HSMQ-C265	InGaN Green	527	150	Non-diffused	45	140	3.4	20
HSMR-C265	InGaN Blue	473	150	Non-diffused	18	45	3.4	20

Quantity: 3,000 per 7 inch reel

# LED Indicators and Displays

## Surface Mount ChipLEDs

Part Number	Color	Dominant Wavelength (nm)	Viewing Angle	Lens	Intensity		Vf Typ. (V)	Test Current (mA)
					Min. (mcd)	Typ. (mcd)		
<b>Bicolor Top Mount 1210 Industrial Footprint (C15x)</b>								
<b>3.2 x 2.7 x 1.1 mm (L x W x H)</b>								
HSMF-C153	GaP Yellow	586	170°	Diffused	2.8	8	2.1	20
	GaP Red	626	170°	Diffused	2.8	10	2.1	20
HSMF-C155	GaP Green	572	170°	Diffused	4.5	15	2.2	20
	GaP Red	626	170°	Diffused	2.8	10	2.1	20
HSMF-C156	GaP Green	572	170°	Diffused	4.5	15	2.2	20
	GaP Yellow	586	170°	Diffused	2.8	8	2.1	20
HSMF-C157	GaP Green	572	170°	Diffused	4.5	15	2.2	20
	GaP Orange	604	170°	Diffused	2.8	8	2.2	20
HSMF-C158	AllnGaP Green	572	170°	Diffused	28.5	45	2.1	20
	AllnGaP Amber	592	170°	Diffused	28.5	55	1.9	20
HSMF-C150	AllnGaP Red	632	170°	Diffused	18	79	1.9	20
	AllnGaP Green	572	170°	Diffused	18	45	2.1	20
HSMF-C15A	AllnGaP Red	632	170°	Diffused	18	79	1.9	20
	AllnGaP Amber	592	170°	Diffused	28.5	55	1.9	20

Quantity: 3,000 per 7 inch reel

<b>Bicolor Top Mount 0603 Industrial Footprint (C16x)</b>								
<b>1.6 x 0.8 x 0.5 mm (L x W x H)</b>								
HSMF-C162	AllnGaP Amber	592	120°	Diffused	28.5	90	1.9	20
	AllnGaP Red	626	120°	Diffused	28.5	90	1.9	20
HSMF-C163	InGaN Green	525	120°	Diffused	18	45	3.4	10
	AllnGaP Red	626	120°	Diffused	11.2	35	1.8	10
HSMF-C164	InGaN Blue	470	120°	Diffused	2.8	10	3.4	10
	AllnGaP Red	626	120°	Diffused	11.2	35	1.8	10
HSMF-C165	GaP Green	572	120°	Diffused	4.5	15	2.2	20
	GaP Red	626	120°	Diffused	2.8	10	2.1	20
HSMF-C166	GaP Green	572	120°	Diffused	4.5	15	2.2	20
	GaP Yellow	586	120°	Diffused	2.8	8	2.1	20
HSMF-C167	GaP Green	572	120°	Diffused	4.5	15	2.2	20
	GaP Orange	604	120°	Diffused	2.8	8	2.2	20
HSMF-C169	InGaN Blue	470	120°	Diffused	2.8	10	3.4	10
	AllnGaP Amber	592	120°	Diffused	11.2	35	1.8	10
HSMF-C16M	AllnGaP Red	632	120°	Diffused	45	104.4	1.9	20
	AllnGaP Green	570	120°	Diffused	45	55.4	2.1	20

Quantity: 3,000 per 7 inch reel

<b>Tricolor Top Mount 1210 Industrial Footprint (C118)</b>								
<b>3.2 x 2.7 x 1.1 mm (L x W x H)</b>								
HSMF-C118	InGaN Green	525	130°	Diffused	45	120	3.5	20
	AllnGaP Red	626	135°	Diffused	28.5	90	1.9	20
	InGaN Blue	470	125°	Diffused	11.2	40	3.5	20

Quantity: 3,000 per 7 inch reel

<b>Tricolor Right Angle with 1.0 mm Height (C11x)</b>								
<b>2.5 x 1.0 x 1.0 mm (L x W x H)</b>								
HSMF-C113	AllnGaP Red	626	120°	Diffused	28.5	80	1.9	20
	AllnGaP Green	572	125°	Diffused	18	50	2	20
	InGaN Blue	470	125°	Diffused	28.5	60	3.4	20
HSMF-C115	AllnGaP Red	626	120°	Diffused	28.5	80	1.9	20
	InGaN Green	525	125°	Diffused	71.5	170	3.4	20
	InGaN Blue	470	125°	Diffused	28.5	60	3.4	20

Quantity: 3,000 per 7 inch reel

# LED Indicators and Displays

## Surface Mount ChipLEDs

Part Number	Color	Dominant Wavelength (nm)	Viewing Angle	Lens	Intensity		Vf Typ. (V)	Test Current (mA)
					Min. (mcd)	Typ. (mcd)		
Tricolor Top Mount with 0.35mm Height (C114)								
<b>1.6 x 0.8 x 0.45 mm (L x W x H)</b>								
HSMF-C114	AllInGaP Red	626	140°	Diffused	28.5	85	1.9	20
	InGaN Green	525	145°	Diffused	45	180	3.4	20
	InGaN Blue	470	145°	Diffused	28.5	70	3.4	20

Quantity: 4,000 per 7 inch reel

Bicolor Right Angle 0.1 mm height (C14x)								
<b>3.0 x 2.0 x 1.0 (L x W x H)</b>								
HSMF-C142	AllInGaP Deep Red	632	120°	Non diffused	18	79	1.9	20
	AllInGaP Green	570	120°	Non diffused	18	33	2.1	20
HSMF-C143	AllInGaP Amber	589	120°	Non diffused	28.5	103	1.9	20
	AllInGaP Green	570	120°	Non diffused	18	33	2.1	20
HSMF-C144	AllInGaP Red	632	120°	Non diffused	18	79	1.9	20
	AllInGaP Green	570	120°	Non diffused	18	33	2.1	20
HSMF-C145	AllInGaP Red	632	120°	Non diffused	18	79	1.9	20
	AllInGaP Green	523	120°	Non diffused	45	223	3.4	20
HSMF-C146	AllInGaP Red	632	120°	Non diffused	18	79	1.9	20
	InGaN Blue	459	120°	Non diffused	28.5	75	3.2	20

Leadframe-based (ASMT-Rx45)								
<b>1.6 x 0.8 x 0.45 mm (L x W x H)</b>								
ASMT-RR45	AllInGaP Red	622	145°	Diffused	50	120	2	20
ASMT-RF45	AllInGaP Yellow Green	573	145°	Diffused	30	60	2	20
ASMT-RA45	AllInGaP Amber	591	145°	Diffused	40	90	2	20

### Color Bin Limits

Package	Color Bin	Wavelength (nm)	
		Min.	Max.
GaN/InGaN Blue	A	460.0	465.0
	B	465.0	470.0
	C	470.0	475.0
	D	475.0	480.0
InGaN Green	A	515.0	520.0
	B	520.0	525.0
	C	525.0	530.0
	D	530.0	535.0
Orange	A	597.0	600.0
	B	600.0	603.0
	C	603.0	606.0
	D	606.0	609.0
	E	609.0	612.0
	F	612.0	615.0
Red	Full Distribution		
AlGaAs Red	Full Distribution		

Tolerance: ± 1.0 nm

Package	Color Bin	Wavelength (nm)	
		Min.	Max.
Green	A	561.5	564.5
	B	564.5	567.5
	C	567.5	570.5
	D	570.5	573.5
	E	573.5	576.5
Yellow	A	582.0	584.5
	B	584.5	587.0
	C	587.0	589.5
	D	589.5	592.0
	E	592.0	594.5
	F	594.5	597.0
Amber	A	582.0	584.5
	B	584.5	587.0
	C	587.0	589.5
	D	589.5	592.0
	E	592.0	594.5
	F	594.5	597.0

Tolerance: ± 1.0 nm

# LED Indicators and Displays

## Surface Mount ChipLEDs

### Standard Intensity Bin Limits

Bin ID	Intensity (mcd)	
	Min.	Max.
A	0.11	0.18
B	0.18	0.29
C	0.29	0.45
D	0.45	0.72
E	0.72	1.10
F	1.10	1.80
G	1.80	2.80
H	2.80	4.50
J	4.50	7.20
K	7.20	11.20
L	11.20	18.00
M	18.00	28.50
N	28.50	45.00
P	45.00	71.50
Q	71.50	112.50
R	112.50	180.00
S	180.00	285.00
T	285.00	450.00
U	450.00	715.00
V	715.00	1125.00
W	1125.00	1800.00
X	1800.00	2850.00
Y	2850.00	4500.00

Tolerance:  $\pm 15\%$

### Package Dimensions

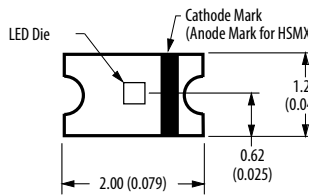

**HSMx-C177**

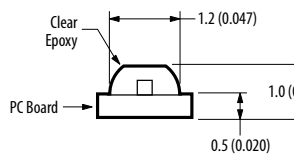

**HSMx-C120/ASMT-Cx00**

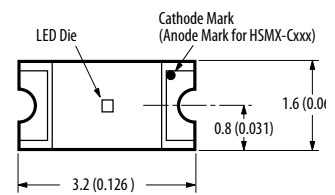

**HSMx-C150**

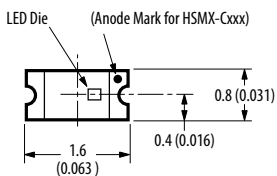

**HSMx-C190/C191/C130**

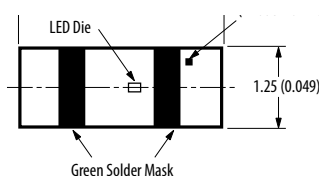

**HSMx-C265**

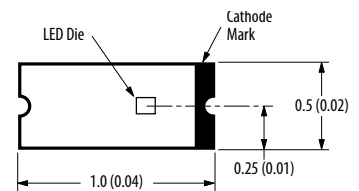

**HSMx-C280**

**Notes:**

1. All dimensions in millimeters (inches).
2. Tolerance is  $\pm 0.1\text{mm}$  ( $\pm 0.004$  in.) unless otherwise specified.

# LED Indicators and Displays

## Through-hole Seven-Segment Displays—Leadframe Platform

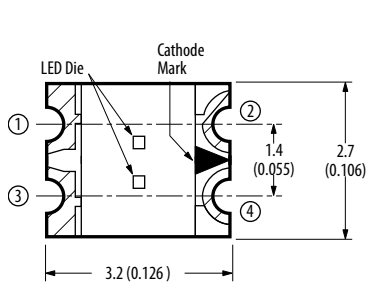

HSMF-C15x

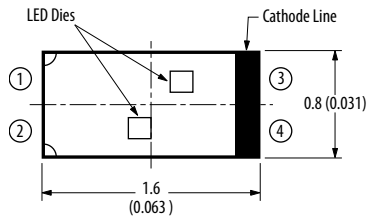

HSMF-C16x

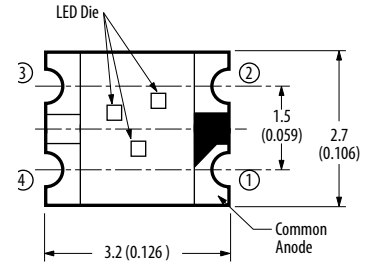

HSMF-C118

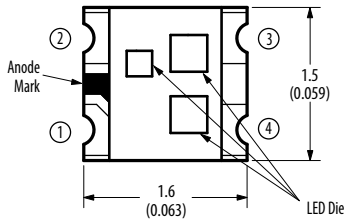

HSMF-C114

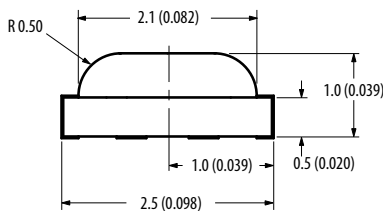

HSMF-C113/C115

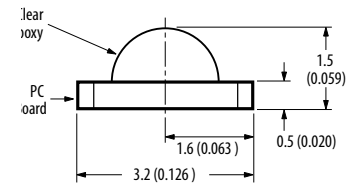

HSMx-C110

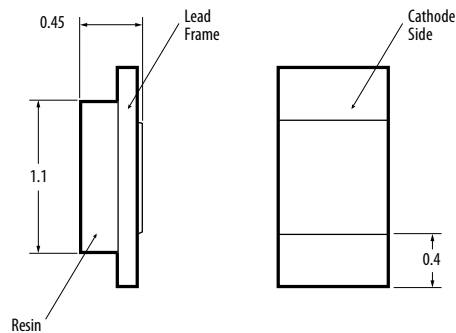
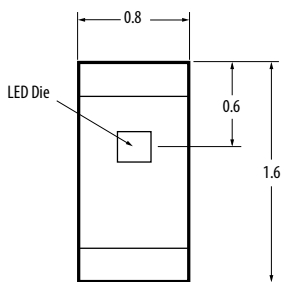

ASMT-RX45

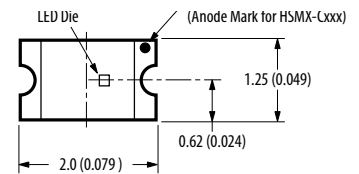

HSMx-C170

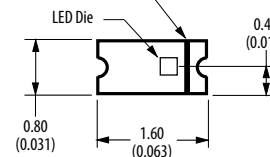

HSMx-C197

**Notes:**

- 1. All dimensions in millimeters (inches).
- 2. Tolerance is  $\pm 0.1\text{mm}$  ( $\pm 0.004\text{ in.}$ ) unless otherwise specified.

## Auto Focus Auxiliary Flash LED

### Description

Avago Technologies offer Auto Focus Auxiliary Flash LEDs in the standard, low profile and miniature package. These are surface mount dome lamps that use an untinted, non-diffused lens to provide a high luminous intensity within a narrow radiation pattern.

These narrow angle SMT lamp packages are designed for applications which require long distance illumination and narrow beam pattern such as auxiliary flash for auto-focus function in digital still camera. The miniature and low profile package are also suitable for applications that have constraints in design area. These devices are compatible with Pb-free reflow soldering process.

The standard Auto Focus Auxiliary Flash LEDs are available in 530nm Green and 605nm Orange. The miniature package is available in 605nm Orange.

### Features and Benefits

- Smooth, Consistent Narrow Radiation Pattern
- Viewing angle optimized for auto focus function
- > 3m illumination distance
- Miniature package: 18° View Angle
- Standard package: Small footprint with 4.8L x 4.8W x 5.33H mm
- Low profile package: 12° viewing angle for Orange; 14° viewing angle for Green
- Low profile package: 3.6L x 3.2W x 3.4H mm package dimension
- Good Intensity Output
- Compatible with 2x Solder Reflow
- Clear, Non-diffused Epoxy
- Allows easy assembly and PCB space saving.
- Compatible with reflow soldering
- IEC/EN 60825-1 Eye Safety Class 1
- RoHS compliant

### Application

- Digital Still Camera

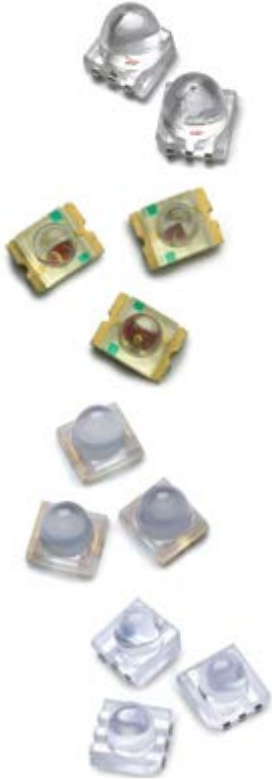



# LED Indicators and Displays

## Standard Auto Focus Auxiliary Flash LED

Part Number	Color	Dominant Wavelength (nm)	Viewing Angle	Lens	Intensity			Vf Typ. (V)	Test Current (mA)	Device Height
					Min. (cd)	Typ. (cd)	Max. Iv (cd)			
ASMT-FJ60-AFJ00	AllInGaP Orange	605	10°	Clear	–	29	–	2.1	20	4.35mm
ASMT-FJ10-ADH00	AllInGaP Orange	605	8°	Clear	9	22	–	2	20	5.33mm
ASMT-FG10-NFJ00	InGaN Green	530	6°	Clear	18	40	56	3.3	20	5.33mm
ASMT-FJ70-AFJ00	AllInGaP Orange	605	12°	Clear	15	25	56	2.1	20	3.40mm
ASMT-FG70-NFJ00	InGaN Green	525	14°	Clear	15	22	56	3.3	20	3.40mm

## Miniature Auto Focus Auxiliary Flash LED

Part Number	Color	Dominant Wavelength (nm)	Viewing Angle	Lens	Intensity			Vf Typ. (V)	Test Current (mA)
					Min. (cd)	Typ. (cd)	Max. Iv (cd)		
ASMT-FJ30-AB000	AllInGaP Orange	605	12°	Clear	5.5	-	–	2	20

## Side Firing Auto Focus Auxiliary Flash LED

Part Number	Color	Dominant Wavelength (nm)	Viewing Angle	Lens	Intensity			Vf Typ. (V)	Test Current (mA)
					Min. (cd)	Typ. (cd)	Max. Iv (cd)		
ASMT-FJ80-AFJ00	AllInGaP Orange	605	10°	Clear	15	25	–	2	20

## Iv Bin Category

Bin ID	Intensity (cd)	
	Min.	Max.
B	5.5	7.0
C	7.0	9.0
D	9.0	11.5
E	11.5	15.0
F	15.0	19.5
F+ **	18.0	19.5
G	19.5	25.5
H	25.5	33.0
I	33.0	43.0
J	43.0	56.0

Iv Tolerance = ±15%

\*\* For ASMT-FG10-NFJ00 only

## Color Bin Category

Bin ID	Wavelength (nm)	
	Min.	Max.
<b>Orange (ASMT-FJ10-xxxxx)</b>		
A	600	604
B	604	608
C	608	612
<b>Orange (ASMT-FJ30-xxxxx)</b>		
1	597	600
2	600	603
3	603	606
4v	606	609
5	609	612
<b>Green</b>		
A	515	520
B	520	525
C	525	530
D	530	535

Tolerance = ±1nm

# LED Indicators and Displays

## Standard Auto Focus Auxiliary Flash LED with 4.35mm Height Package Dimensions

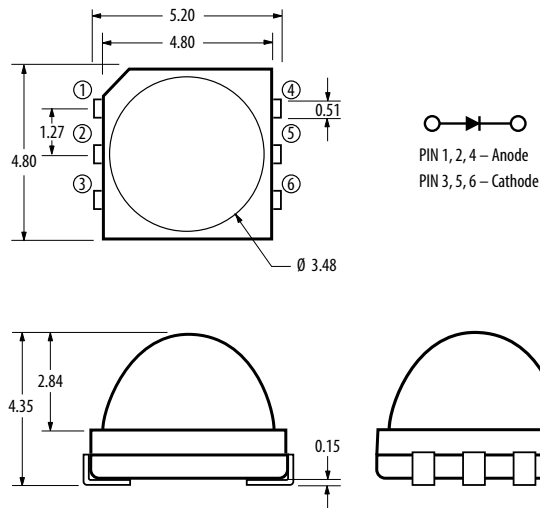

## Miniature Auto Focus Auxiliary Flash LED Package Dimensions

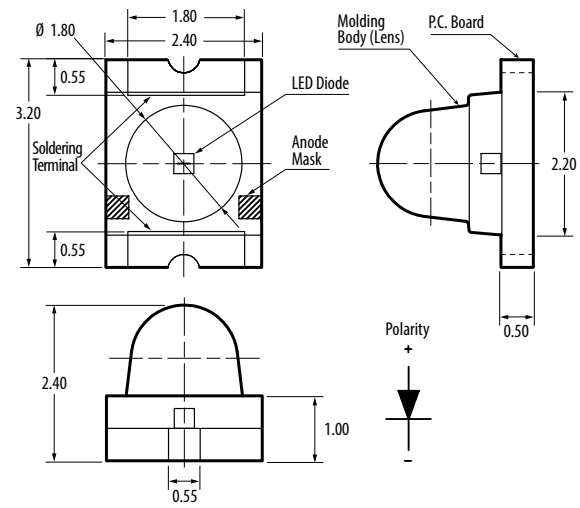

## Standard Auto Focus Auxiliary Flash LED with 5.33 Height Package Dimensions

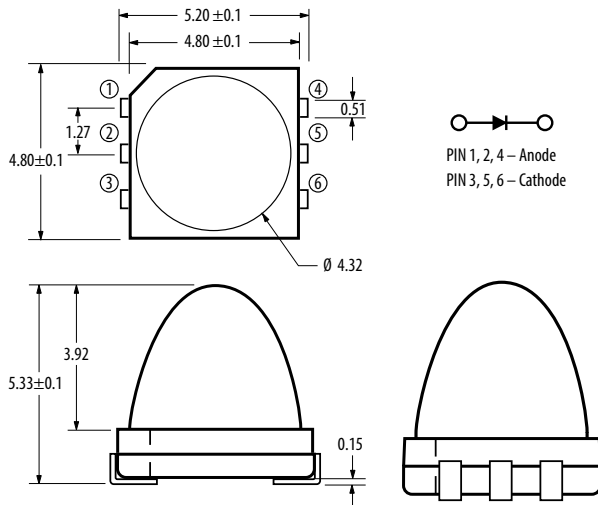

## Standard Auto Focus Flash LED with 3.40mm Height Package Dimensions

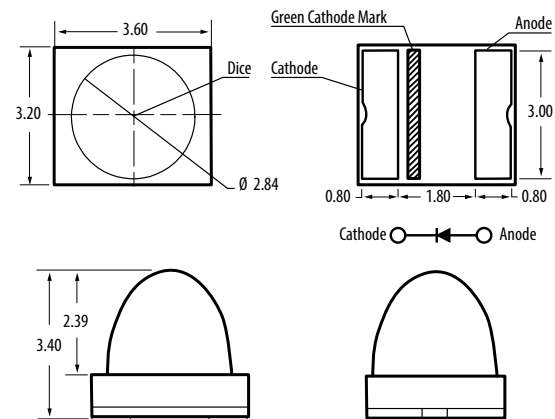

## Side Firing Auto Focus Auxiliary Flash LED Package dimensions

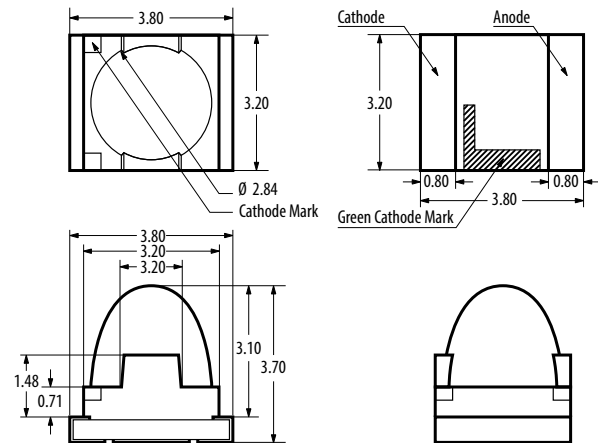

### Notes:

1. All dimensions in millimeters.
2. Tolerance is  $\pm 0.1$ mm unless otherwise specified.

## Seven-Segment Displays

### Description

Avago Technologies offers a full range of seven-segment displays from low cost, standard brightness displays to high ambient light displays that produce up to 78 mcd per segment. Dual and single digit displays are available in assorted character heights and colors. They are divided into two platforms to address different market requirements in both industrial and consumer markets. Displays for industrial markets are designed for high-reliability applications and feature extremely durable packaging for high temperature environments. Consumer applications are designed for cost-sensitive, general-purpose display applications.

### Product Features and Benefits

- Semiconductor (LED) light source
  - Cost-effective solutions
  - Flexibility for designers
  - Light weight
- Lower power consumption
  - Electrical power savings
  - Low heat generation
  - Low current devices available
- Mechanically rugged
  - No wire filaments
  - No moving parts
  - Not sensitive to mechanical shock and vibration
- Essentially monochromatic light
  - No color filter required
  - Maximum use of visible light
  - Easy for the eye to discern against distracting backgrounds in sunlight and adverse weather conditions
- High light output
- Industry standard size and pinout
- Categorized for luminous intensity (yellow and green categorized for color)

### Industrial Applications: High Performance Seven-segment Display Package

Industrial grade products provide high peak current, automated IV/color binning and the availability of intensity and color selection. Ideal for high reliability applications such as temperature controllers, this package is extremely durable in high temperature environments with better heat dissipation through a mild steel leadframe.

### Key benefits for the leadframe platform

- Heat dissipation from the package is faster than other PCB display products
- Brightness (Iv) degradation reduced over time
- Lead stability and consistency
- Solder coated leads result in better solderability

### Consumer Applications: Standard Seven-segment Display Package

Designed for the cost-competitive general purpose commercial LED display applications, this package is built with a PCB substrate using ultrasonic stitch-to-stitch bonding with aluminum wire.

### Key benefits for the PCB platform

- Competitive prices
- Avago Technologies quality, reliability and technical support

Avago Technologies is committed to support the market by offering display performance and features that are specific to the designer's application requirements.

### Typical Industrial Applications

HighPerformance Seven-segment Displays:

- Temperature controllers
- Test and measurement instrumentation
- Power converters
- Home appliance displays
- Automotive and avionic instrumentation
- Fuel pump displays
- Digital panel meters

### Typical Consumer Applications





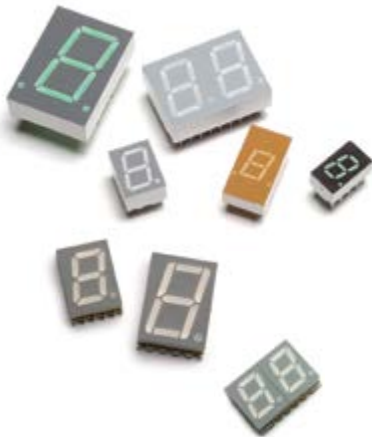



Standard Seven-segment Displays:

- Cable set-top boxes
- Electronics displays
- Gaming machines
- Point of sale terminals
- Answering machines
- Exercise equipment





# LED Indicators and Displays



## Through-hole Seven-Segment Displays—Leadframe Platform



Part Number	Face Color	Pin Configuration	Intensity ( $\mu\text{cd}$ )		Iv Test Current (mA)	Vf Typ. (V)	Vf Test Current (mA)
			Min.	Typ.			
<b>7.6 mm (0.3") Micro Bright Displays (right decimal point)</b>							
<b>GaP Red 626 nm</b> 							
HDSP-7501	Grey	Common Anode	360	980	5	2	20
HDSP-A211	Black	Common Anode	360	980	5	2	20
HDSP-7503	Grey	Common Cathode	360	980	5	2	20
HDSP-A213	Black	Common Cathode	360	980	5	2	20
<b>GaP Orange 600 nm</b> 							
HDSP-A401	Grey	Common Anode	354	720	5	2	20
HDSP-A403	Grey	Common Cathode	354	720	5	2	20
HDSP-A413	Black	Common Cathode	354	720	5	2	20
<b>GaP Yellow 586 nm</b> 							
HDSP-7401	Grey	Common Anode	225	480	5	2.2	20
HDSP-7403	Grey	Common Cathode	225	480	5	2.2	20
<b>High Performance Green 571 nm</b> 							
HDSP-7801	Grey	Common Anode	860	3000	10	2.1	10
HDSP-A511	Black	Common Anode	860	3000	10	2.1	10
HDSP-7803	Grey	Common Cathode	860	3000	10	2.1	10
HDSP-A513	Black	Common Cathode	860	3000	10	2.1	10
<b>GaP AlGaAs Red 637 nm</b> 							
HDSP-A151	Grey	Common Anode	690	1400	20	1.8	20
HDSP-A153	Grey	Common Cathode	690	1400	20	1.8	20
<b>7.6 mm (0.3") Micro Bright Low Current Displays (right decimal point)</b>							
<b>GaP AlGaAs Red 637 nm</b> 							
HDSP-A101	Grey	Common Anode	315	600	1	1.6	1
HDSP-A103	Grey	Common Cathode	315	600	1	1.6	1
HDSP-A113	Black	Common Cathode	315	600	1	1.6	1
<b>GaP Red 626 nm</b> 							
HDSP-7511	Grey	Common Anode	160	270	2	1.6	2
HDSP-7513	Grey	Common Cathode	160	270	2	1.6	2
<b>GaP Yellow 585 nm</b> 							
HDSP-A801	Grey	Common Anode	250	420	4	1.7	4
HDSP-A803	Grey	Common Cathode	250	420	4	1.7	4
<b>GaP Green 571 nm</b> 							
HDSP-A901	Grey	Common Anode	250	475	4	1.9	4
HDSP-A903	Grey	Common Cathode	250	475	4	1.9	4

## LED Indicators and Displays

### Through-hole Seven-Segment Displays—Leadframe Platform





Part Number	Face Color	Pin Configuration	Intensity ( $\mu\text{cd}$ )		Iv Test Current (mA)	Vf Typ. (V)	Vf Test Current (mA)
			Min.	Typ.			
7.6 mm (0.3") Micro Bright Overflow Displays (right decimal point)							
<b>GaP Red 626 nm</b> 							
HDSP-7507	Grey	Common Anode	360	980	5	2	20
HDSP-7508	Grey	Common Cathode	360	980	5	2	20
HDSP-7517	Grey	Common Anode	160	270	2	1.6	2
<b>GaP Green 571 nm</b> 							
HDSP-7807	Grey	Common Anode	860	3000	10	2.1	10
HDSP-7808	Grey	Common Cathode	860	3000	10	2.1	10

Part Number	Face Color	Pin Configuration	Intensity ( $\mu\text{cd}$ )		Iv Test Current (mA)	Vf Typ. (V)	Vf Test Current (mA)
			Min.	Typ.			
<b>AlGaAs Red 637 nm (right hand decimal)</b> 							
HDSP-A107	Grey	Common Anode	135	600	1	1.6	1
HDSP-A108	Grey	Common Cathode	135	600	1	1.6	1
HDSP-A113	Black	Common Cathod	315	600	1	1.6	1
<b>GaP Yellow 586 nm</b> 							
HDSP-A807	Grey	Common Anode	250	420	4	1.7	4
<b>GaP Green 571 nm</b> 							
HDSP-A907	Grey	Common Anode	250	475	5	1.9	4
HDSP-A908	Grey	Common Cathode	250	475	5	1.9	4

Part Number	Face Color	Pin Configuration	Intensity		Iv Test Current (mA)	Vf Typ. (V)	Vf Test Current (mA)	Decimal Point
			Min.	Typ.				
7.6 mm (0.3") Single Digit Displays								
<b>GaP Red 626 nm</b> 								
5082-7610	Red	Common Anode	340	800	5	2.1	20	Left
5082-7611	Red	Common Anode	340	800	5	2.1	20	Right
5082-7613	Red	Common Cathode	340	800	5	2.1	20	Right
<b>GaP Yellow 586 nm</b> 								
5082-7620	Yellow	Common Anode	205	620	5	2.2	20	Left
5082-7621	Yellow	Common Anode	205	620	5	2.2	20	Right
5082-7623	Yellow	Common Cathode	205	620	5	2.2	20	Right
<b>GaP Green 571 nm</b> 								
HDSP-3600	Green	Common Anode	860	2700	10	2.1	10	Left
HDSP-3601	Green	Common Anode	860	2700	10	2.1	10	Right
HDSP-3603	Green	Common Cathode	860	2700	10	2.1	10	Right







# LED Indicators and Displays

## Through-hole Seven-Segment Displays—Leadframe Platform

Part Number	Face Color	Pin Configuration	Intensity ( $\mu\text{cd}$ )		Iv Test Current (mA)	Vf Typ. (V)	Vf Test Current (mA)
			Min.	Typ.			
<b>8 mm (0.31") Micro Bright Displays (right decimal point)</b>							
<b>AlGaAs Red 637 nm</b> 							
HDSP-U101	Grey	Common Anode	315	600	1	1.8	20
HDSP-U111	Black	Common Anode	315	600	1	1.8	20
HDSP-U103	Grey	Common Cathode	315	600	1	1.8	20
HDSP-U113	Black	Common Cathode	315	600	1	1.8	20
<b>GaP Red 626 nm</b> 							
HDSP-U201	Grey	Common Anode	360	980	5	2	20
HDSP-U211	Black	Common Anode	360	980	5	2	20
HDSP-U203	Grey	Common Cathode	360	980	5	2	20
HDSP-U213	Black	Common Cathode	360	980	5	2	20
<b>GaP Orange 600 nm</b> 							
HDSP-U401	Grey	Common Anode	360	980	5	2	20
HDSP-U411	Black	Common Anode	360	980	5	2	20
HDSP-U403	Grey	Common Cathode	360	980	5	2	20
HDSP-U413	Black	Common Cathode	360	980	5	2	20
<b>GaP Yellow 586 nm</b> 							
HDSP-U301	Grey	Common Anode	225	480	5	2.2	20
HDSP-U311	Black	Common Anode	225	480	5	2.2	20
HDSP-U303	Grey	Common Cathode	225	480	5	2.2	20
HDSP-U313	Black	Common Cathode	225	480	5	2.2	20
<b>GaP Green 571 nm</b> 							
HDSP-U501	Grey	Common Anode	860	3000	10	2.1	10
HDSP-U511	Black	Common Anode	860	3000	10	2.1	10
HDSP-U503	Grey	Common Cathode	860	3000	10	2.1	10
HDSP-U513	Black	Common Cathode	860	3000	10	2.1	10





# LED Indicators and Displays



## Through-hole Seven-Segment Displays—Leadframe Platform

Part Number	Face Color	Pin Configuration	Intensity ( $\mu\text{cd}$ )		Iv Test Current (mA)	Vf Typ. (V)	Vf Test Current (mA)
			Min.	Typ.			
<b>10 mm (0.4") Single Digit Displays (right decimal point)</b>							
<b>AlGaAs Red 637 nm</b> 							
HDSP-F111	Black	Common Anode	330	650	1	1.6	1
HDSP-F101	Grey	Common Anode	330	650	1	1.6	1
HDSP-F113	Black	Common Cathode	330	650	1	1.6	1
HDSP-F103	Grey	Common Cathode	330	650	1	1.8	1
HDSP-F151	Grey	Common Anode	7500	15000	20	1.8	20
HDSP-F153	Grey	Common Cathode	7500	15000	20	1.8	20
HDSP-F161	Black	Common Anode	7500	15000	20	1.8	20
<b>GaP Red 626 nm</b> 							
HDSP-F211	Black	Common Anode	420	1200	5	2	20
HDSP-F201	Grey	Common Anode	420	1200	5	2	20
HDSP-F213	Black	Common Cathode	420	1200	5	2	20
HDSP-F203	Grey	Common Cathode	420	1200	5	2	20
<b>GaP Orange 603 nm</b> 							
HDSP-F401	Grey	Common Anode	420	1200	5	2	20
HDSP-F413	Black	Common Cathode	420	1200	5	2	20
HDSP-F403	Grey	Common Cathode	420	1200	5	2	20
<b>GaP Yellow 586 nm</b> 							
HDSP-F301	Grey	Common Anode	290	800	5	2.2	20
HDSP-F303	Grey	Common Cathode	290	800	5	2.2	20
<b>GaP Green 571 nm</b> 							
HDSP-F511	Black	Common Anode	1030	3500	10	2.1	10
HDSP-F501	Grey	Common Anode	1030	3500	10	2.1	10
HDSP-F513	Black	Common Cathode	1030	3500	10	2.1	10
HDSP-F503	Grey	Common Cathode	1030	3500	10	2.1	10
<b>10 mm (0.4") Overflow Displays (right decimal point)</b>							
<b>AlGaAs Red 637 nm</b> 							
HDSP-F107	Grey	Common Anode	330	650	1	1.6	1
HDSP-F108	Grey	Common Cathode	330	650	1	1.6	1
HDSP-F157	Grey	Common Anode	7500	15000	20	1.8	20
HDSP-F158	Grey	Common Cathode	7500	15000	20	1.8	20
<b>GaP Red 626 nm</b> 							
HDSP-F207	Grey	Common Anode	420	1200	5	2	20
HDSP-F208	Grey	Common Cathode	420	1200	5	2	20

# LED Indicators and Displays

## Through-hole Seven-Segment Displays—Leadframe Platform

Part Number	Face Color	Pin Configuration	Intensity		Iv Test Current (mA)	Vf Typ. (V)	Vf Test Current (mA)	Decimal Point
			Min.	Typ.				
<b>10.9 mm (0.43") Single Digit Displays</b>								
<b>AlGaAs Red 637 nm</b> 								
HDSP-E101	Grey	Common Anode	390	650	1	1.6	1	Right
HDSP-E103	Grey	Common Cathode	390	650	1	1.6	1	Right
HDSP-E151	Grey	Common Anode	8500	15000	20	1.8	20	Right
HDSP-E153	Grey	Common Cathode	8500	15000	20	1.8	20	Right
<b>GaP Red 626 nm</b> 								
5082-7650	Red	Common Anode	340	1115	5	2.1	20	Left
5082-7651	Red	Common Anode	340	1115	5	2.1	20	Right
5082-7653	Red	Common Cathode	340	1115	5	2.1	20	Right
<b>GaP Red 626 nm — Low Current</b> 								
HDSP-3351	Red	Common Anode	200	300	2	1.6	2	Right
HDSP-3353	Red	Common Cathode	200	300	2	1.6	2	Right
<b>GaP Yellow 586 nm</b> 								
5082-7661	Yellow	Common Anode	290	835	5	2.2	20	Right
5082-7663	Yellow	Common Cathode	290	835	5	2.2	20	Right
<b>GaP Green 571 nm</b> 								
HDSP-4600	Grey	Common Anode	1030	4000	10	2.1	10	Left
HDSP-4601	Grey	Common Anode	1030	4000	10	2.1	10	Right
HDSP-4603	Grey	Common Cathode	1030	4000	10	2.1	10	Right
<b>10.9mm (0.43") Overflow Displays</b>								
HDSP-3356	Red	Universal	200	300	2	1.6	2	Right

Part Number	Face Color	Pin Configuration	Intensity		Iv Test Current (mA)	Vf Typ. (V)	Vf Test Current (mA)	Decimal Point
			Min.	Typ.				
<b>GaP Red 626 nm — Low Current</b> 								
5082-7656	Red	—	340	1115	5	2.1	20	Right
<b>GaP Yellow 586 nm</b> 								
5082-7666	Yellow	—	290	835	5	2.2	20	Right
<b>GaP Green 571 nm</b> 								
HDSP-4606	Grey	—	1030	4000	10	2.1	10	Right







# LED Indicators and Displays





## Through-hole Seven-Segment Displays—Leadframe Platform

Part Number	Face Color	Pin Configuration	Intensity ( $\mu\text{cd}$ )		I <sub>v</sub> Test Current (mA)	V <sub>f</sub> Typ. (V)	V <sub>f</sub> Test Current (mA)
			Min.	Typ.			
<b>14.2 mm (0.56") Single Digit Displays (right decimal point)</b>							
<b>AlGaAs Red 637 nm</b> <span style="color: red;">■</span>							
HDSP-H111	Black	Common Anode	400	700	1	1.6	1
HDSP-H101	Grey	Common Anode	400	700	1	1.6	1
HDSP-H113	Black	Common Cathode	400	700	1	1.6	1
HDSP-H103	Grey	Common Cathode	400	700	1	1.6	1
HDSP-H151	Grey	Common Anode	9100	16000	20	1.8	20
HDSP-H153	Grey	Common Cathode	9100	16000	20	1.8	20
<b>GaP Red 626 nm</b> <span style="color: red;">■</span>							
HDSP-H211	Black	Common Anode	900	2800	10	2	20
HDSP-5501	Grey	Common Anode	900	2800	10	2.1	20
HDSP-H213	Black	Common Cathode	900	2800	10	2	20
HDSP-5503	Grey	Common Cathode	900	2800	10	2.1	20
<b>GaP Red 626 nm — Low Current</b> <span style="color: red;">■</span>							
HDSP-5551	Grey	Common Anode	270	370	2	1.6	2
HDSP-5553	Grey	Common Cathode	270	370	2	1.6	2
<b>GaP Orange 600 nm</b> <span style="color: orange;">■</span>							
HDSP-H413	Black	Common Cathode	1190	2000	10	2	20
<b>GaP Yellow 586 nm</b> <span style="color: yellow;">■</span>							
HDSP-5701	Grey	Common Anode	600	1800	10	2.1	20
HDSP-5703	Grey	Common Cathode	600	1800	10	2.1	20
<b>GaP Green 571 nm</b> <span style="color: green;">■</span>							
HDSP-H511	Black	Common Anode	900	2500	10	2.1	10
HDSP-5601	Grey	Common Anode	900	2500	10	2.1	10
HDSP-H513	Black	Common Cathode	900	2500	10	2.1	10
HDSP-5603	Grey	Common Cathode	900	2500	10	2.1	10
<b>14.2 mm (0.56") Overflow Displays (right decimal point)</b>							
<b>AlGaAs Red 637 nm</b> <span style="color: red;">■</span>							
HDSP-H107	Grey	Common Anode	400	700	1	1.6	1
HDSP-H108	Grey	Common Cathode	400	700	1	1.6	1
HDSP-H157	Grey	Common Anode	9100	16000	20	1.8	20
HDSP-H158	Grey	Common Cathode	9100	16000	20	1.8	20
<b>GaP Red 626 nm</b> <span style="color: red;">■</span>							
HDSP-5507	Grey	Common Anode	900	2800	10	2.1	20
HDSP-5508	Grey	Common Cathode	900	2800	10	2.1	20
<b>GaP Red 626 nm — Low Current</b> <span style="color: red;">■</span>							
HDSP-5557	Grey	Common Anode	270	370	2	1.6	2
HDSP-5558	Grey	Common Cathode	270	370	2	1.6	2
<b>GaP Green 571 nm</b> <span style="color: green;">■</span>							
HDSP-5607	Grey	Common Anode	900	2500	10	2.1	10
HDSP-5608	Grey	Common Cathode	900	2500	10	2.1	10

# LED Indicators and Displays









## Through-hole Seven-Segment Displays—Leadframe Platform

Part Number	Face Color	Pin Configuration	Intensity ( $\mu\text{cd}$ )		Iv Test Current (mA)	Vf Typ. (V)	Vf Test Current (mA)
			Min.	Typ.			
14.2 mm (0.56") Dual Digit Displays (right decimal point)							
<b>AlGaAs Red 637 nm</b> 							
HDSP-K121	Grey	Common Anode	400	700	1	1.6	1
HDSP-K123	Grey	Common Cathode	400	700	1	1.6	1
<b>AlGaAs Red 637 nm – Low Current</b>							
HDSP-K111	Black	Common Anode	400	700	1	1.6	1
HDSP-K113	Black	Common Cathode	400	700	1	1.6	1
<b>GaP Red 626 nm</b> 							
HDSP-5521	Grey	Common Anode	900	2800	10	2.1	20
HDSP-5523	Grey	Common Cathode	900	2800	10	2.1	20
HDSP-K211	Black	Common Anode	900	2800	10	2.0	20
HDSP-K213	Black	Common Anode	900	2800	10	2.0	20
<b>GaP Yellow 586 nm</b> 							
HDSP-5721	Grey	Common Anode	600	1800	10	2.1	10
HDSP-5723	Grey	Common Cathode	600	1800	10	2.1	10
<b>GaP Green 571 nm</b> 							
HDSP-5621	Grey	Common Anode	900	2500	10	2.1	10
HDSP-5623	Grey	Common Cathode	900	2500	10	2.1	10
HDSP-K511	Black	Common Anode	900	2500	10	2.1	10
HDSP-K513	Black	Common Cathode	900	2500	10	2.1	10

Part Number	Face Color	Pin Configuration	Intensity		Iv Test Current (mA)	Vf Typ. (V)	Vf Test Current (mA)	Decimal Point
			Min.	Typ.				
20 mm (0.8") Single Digit Displays								
<b>AlGaAs Red 637 nm</b> 								
HDSP-N101	Grey	Common Anode	270	590	1	1.6	1	Right
HDSP-N103	Grey	Common Cathode	270	590	1	1.6	1	Right
HDSP-N105	Grey	Common Cathode	270	590	1	1.6	1	Left
HDSP-N150	Grey	Common Anode	6000	14000	20	1.8	20	Left
HDSP-N151	Grey	Common Anode	6000	14000	20	1.8	20	Right
HDSP-N153	Grey	Common Cathode	6000	14000	20	1.8	20	Right
<b>GaP Red 626 nm</b> 								
HDSP-3900	Grey	Common Anode	3350	48000	20	2.6	100	Left
HDSP-3901	Grey	Common Anode	3350	7000 Peak (1/5 df)		2.6	100	Right
HDSP-3903	Grey	Common Cathode	3350	7000		2.6	100	Right
HDSP-3905	Grey	Common Cathode	3350	7000		2.6	100	Left
<b>GaP Yellow 586 nm</b> 								
HDSP-4201	Grey	Common Anode	2200	7000		2.6	100	Right
HDSP-4203	Grey	Common Cathode	2200	7000		2.6	100	Right
<b>GaP Green 571 nm</b> 								
HDSP-8601	Grey	Common Anode	680	1500	10	2.1	10	Right
HDSP-8603	Grey	Common Cathode	680	1500	10	2.1	10	Right







# LED Indicators and Displays

## Through-hole Seven-Segment Displays—PCB Platform

Part Number	Face Color	Pin Configuration	Intensity ( $\mu\text{cd}$ )		Iv Test Current (mA)	Vf Typ. (V)	Vf Test Current (mA)	Decimal Point
			Min.	Typ.				
<b>7.62 mm (0.3") Single Digit Display</b>								
<b>GaP Red 620 nm</b> 								
HDSP-333E	Grey	Common Cathode	800	1800	10	2.05	20	Right
<b>GaP Green 573 nm</b> 								
HDSP-333G	Grey	Common Cathode	800	2000	10	2.25	20	Right
<b>AlGaAs Red 643 nm</b> 								
HDSP-333A	Grey	Common Cathode	2001	4200	10	1.85	20	Right
<b>9.1 mm (0.36") Single Digit Display</b>								
<b>AlGaAs Red 643 nm</b> 								
HDSP-C3A1	Grey	Common Anode	–	7500	10	1.85	20	Right
HDSP-C3A3	Grey	Common Cathode	–	7500	10	1.85	20	Right
<b>GaAsP Red 626 nm</b> 								
HDSP-C3E1	Grey	Common Anode	–	1100	10	2.0	20	Right
HDSP-C3E3	Grey	Common Cathode	–	1100	10	2.0	20	Right
<b>10 mm (0.4") Slim Font Single Digit Display</b>								
<b>GaP Red 625 nm</b> 								
HDSP-301E	Grey	Common Anode	1100	1100	10	1.90	20	Right
HDSP-303E	Grey	Common Cathode	1100	1100	10	1.90	20	Right
<b>GaP Green 573 nm</b> 								
HDSP-301G	Grey	Common Anode	1800	2800	10	2.25	20	Right
HDSP-303G	Grey	Common Cathode	1800	2800	10	2.25	20	Right
<b>AlGaAs Red 643 nm</b> 								
HDSP-301A	Grey	Common Anode	280	450	1	1.80	20	Right
HDSP-303A	Grey	Common Cathode	280	450	1	1.80	20	Right
<b>GaP Yellow 590 nm</b> 								
HDSP-301Y	Grey	Common Anode	1100	1800	10	2.15	20	Right
HDSP-303Y	Grey	Common Cathode	1100	1800	10	2.15	20	Right





# LED Indicators and Displays

## Through-hole Seven-Segment Displays—PCB Platform

Part Number	Face Color	Pin Configuration	Intensity ( $\mu\text{cd}$ )		Iv Test Current (mA)	Vf Typ. (V)	Vf Test Current (mA)	Decimal Point
			Min.	Typ.				
<b>10.16 mm (0.4") Single Digit Display</b>								
<b>GaP Red 620 nm</b> 								
HDSP-311E	Grey	Common Anode	1250	3200	10	2.05	20	Right
HDSP-313E	Grey	Common Cathode	1250	3200	10	2.05	20	Right
<b>GaP Green 573 nm</b> 								
HDSP-311G	Grey	Common Anode	1250	3200	10	2.25	20	Right
HDSP-313G	Grey	Common Cathode	1250	3200	10	2.25	20	Right
<b>AlGaAs Red 643 nm</b> 								
HDSP-311A	Grey	Common Anode	3200	7500	10	1.85	20	Right
HDSP-313A	Grey	Common Cathode	3200	7500	10	1.85	20	Right
<b>GaP Yellow 590 nm</b> 								
HDSP-311Y	Grey	Common Anode	800	1500	10	2.15	20	Right
HDSP-313Y	Grey	Common Cathode	800	1500	10	2.15	20	Right
<b>10.16 mm (0.4") Dual Digit Display</b>								
<b>GaP Red 620 nm</b> 								
HDSP-G01E	Grey	Common Anode	1250	2600	10	2.05	20	–
HDSP-G03E	Grey	Common Cathode	1250	2600	10	2.05	20	–
<b>GaP Green 573 nm</b> 								
HDSP-G01G	Grey	Common Anode	1250	3200	10	2.25	20	–
HDSP-G03G	Grey	Common Cathode	1250	3200	10	2.25	20	–
<b>AlGaAs Red 643nm</b> 								
HDSP-G01A	Grey	Common Anode	3200	6500	10	1.85	20	–
HDSP-G03A	Grey	Common Cathode	3200	6500	10	1.85	20	–
<b>GaP Yellow 590 nm</b> 								
HDSP-G01Y	Grey	Common Anode	800	1500	10	2.15	20	–
HDSP-G03Y	Grey	Common Cathode	800	1500	10	2.15	20	–

# LED Indicators and Displays

## Through-hole Seven-Segment Displays—PCB Platform

Part Number	Face Color	Pin Configuration	Intensity ( $\mu\text{cd}$ )		Iv Test Current (mA)	Vf Typ. (V)	Vf Test Current (mA)	Decimal Point
			Min.	Typ.				
<b>0.56" Slim Font Single Digit Display</b>								
<b>GaP Red 625 nm</b> 								
HDSP-561E	Grey	Common Anode	1100	1800	10	1.90	20	Right
HDSP-563E	Grey	Common Cathode	1100	1800	10	1.90	20	Right
<b>GaP Green 573 nm</b> 								
HDSP-561G	Grey	Common Anode	1800	2800	10	2.25	20	Right
HDSP-563G	Grey	Common Cathode	1800	2800	10	2.25	20	Right
<b>AlGaAs Red 643 nm</b> 								
HDSP-561A	Grey	Common Anode	280	450	1	2.1	20	Right
HDSP-563A	Grey	Common Cathode	280	450	1	2.1	20	Right
<b>GaP Yellow 590 nm</b> 								
HDSP-561Y	Grey	Common Anode	1800	2800	10	1.80	20	Right
HDSP-563Y	Grey	Common Cathode	1800	2800	10	1.80	20	Right
<b>13.1mm (0.52") Single Digit Display</b>								
<b>AlGaAs Red 643nm</b> 								
HDSP-C5A1	Grey	Common Anode	–	16000	10	1.85	20	Right
HDSP-C5A3	Grey	Common Cathode	–	16000	10	1.85	20	Right







# LED Indicators and Displays

## Through-hole Seven-Segment Displays—PCB Platform

Part Number	Face Color	Pin Configuration	Intensity ( $\mu\text{cd}$ )		Iv Test Current (mA)	Vf Typ. (V)	Vf Test Current (mA)	Decimal Point
			Min.	Typ.				
<b>14.22 mm (0.56") Single Digit Display</b>								
<b>GaP Red 620 nm</b> 								
HDSP-511E	Grey	Common Anode	2001	4100	10	2.05	20	Right
HDSP-513E	Grey	Common Cathode	2001	4100	10	2.05	20	Right
<b>GaP Green 573 nm</b> 								
HDSP-511G	Grey	Common Anode	2001	4100	10	2.25	20	Right
HDSP-513G	Grey	Common Cathode	2001	4100	10	2.25	20	Right
<b>AlGaAs Red 643 nm</b> 								
HDSP-511A	Grey	Common Anode	3201	6500	10	1.85	20	Right
HDSP-513A	Grey	Common Cathode	3201	6500	10	1.85	20	Right
<b>GaP Yellow 590 nm</b> 								
HDSP-511Y	Grey	Common Anode	1251	2600	10	2.15	20	Right
HDSP-513Y	Grey	Common Cathode	1251	2600	10	2.15	20	Right
<b>14.2 mm (0.56") Dual Digit Displays</b>								
<b>GaP Yellow 587 nm</b> 								
HDSP-521Y	Grey	Common Anode	1520	2300	10	2.1	20	Right
HDSP-523Y	Grey	Common Cathode	1520	2300	10	2.1	20	Right
<b>GaP Red 626 nm</b> 								
HDSP-521E	Grey	Common Anode	2280	4000	10	2.1	20	Right
HDSP-523E	Grey	Common Cathode	2280	4000	10	2.1	20	Right
<b>GaP Green 571 nm</b> 								
HDSP-521G	Grey	Common Anode	2280	3500	10	2.1	10	Right
HDSP-523G	Grey	Common Cathode	2280	3500	10	2.1	10	Right
<b>AlGaAs Red 643 nm</b> 								
HDSP-521A	Grey	Common Anode	–	6500	10	1.85	20	Right
HDSP-523A	Grey	Common Cathode	–	6500	10	1.85	20	Right











# LED Indicators and Displays

## Through-hole Seven-Segment Displays—PCB Platform

Part Number	Face Color	Pin Configuration	Intensity ( $\mu\text{cd}$ )		Iv Test Current (mA)	Vf Typ. (V)	Vf Test Current (mA)	Decimal Point
			Min.	Typ.				
<b>20 mm (0.8") Single Digit Display</b>								
<b>GaP Red 626 nm</b> 								
HDSP-815E	Grey	Common Anode	2300	4800	20	2.1	20	Right
HDSP-816E	Grey	Common Cathode	2300	4800	20	2.1	20	Right
<b>GaP Green 571 nm</b> 								
HDSP-815G	Grey	Common Anode	1500	3300	20	2.1	20	Right
HDSP-816G	Grey	Common Cathode	1500	3300	20	2.1	20	Right
<b>20mm (0.8")Single Digit Display</b>								
<b>AlGaAs Red 643nm</b> 								
HDSP-C8A1	Grey	Common Anode	–	18200	10	1.85	20	Right
HDSP-C8A3	Grey	Common Cathode	–	18200	10	1.85	20	Right
<b>GaAsP Red 626nm</b> 								
HDSP-C8E1	Grey	Common Anode	–	4800	10	2.0	20	Right
HDSP-C8E3	Grey	Common Cathode	–	4800	10	2.0	20	Right
<b>GaAsP Orange</b> 								
HDSP-C8L1	Grey	Common Anode	–	4500	10	2.15	20	Right
HDSP-C8L3	Grey	Common Cathode	–	4500	10	2.15	20	Right
<b>GaP Green</b> 								
HDSP-C8G1	Grey	Common Anode	–	5000	10	2.25	20	Right
HDSP-C8G3	Grey	Common Cathode	–	5000	10	2.25	20	Right

# LED Indicators and Displays





## Surface Mount Seven-Segment Displays—PCB Platform

Part Number	Face Color	Pin Configuration	Intensity (mcd)		Iv Test Current (mA)	Vf Typ. (V)	Vf Test Current (mA)	Decimal Point
			Min.	Typ.				
<b>7.0mm (0.28") Single Digit SMT Display</b>								
<b>AllInGaP Red 624 nm</b> 								
HDSM-281C	Grey	Common Anode	3.4	7.5	10	2	20	Upper and Lower
HDSM-283C	Grey	Common Cathode	3.4	7.5	10	2	20	Upper and Lower
<b>AllInGaP Green 571 nm</b> 								
HDSM-281H	Grey	Common Anode	3.4	6	10	2.1	20	Upper and Lower
HDSM-283H	Grey	Common Cathode	3.4	6	10	2.1	20	Upper and Lower
<b>AllInGaP Yellow 589 nm</b> 								
HDSM-281F	Grey	Common Anode	3.4	8	10	2.1	20	Upper and Lower
HDSM-283F	Grey	Common Cathode	3.4	8	10	2.1	20	Upper and Lower
<b>AllInGaP Orange 605 nm</b> 								
HDSM-281L	Grey	Common Anode	3.4	8.5	10	2.1	20	Upper and Lower
HDSM-283L	Grey	Common Cathode	3.4	8.5	10	2.1	20	Upper and Lower
<b>InGaN Blue 470nm</b> 								
HDSM-281B	Grey	Common Anode	3.4	6	10	3.3	20	Upper and Lower
HDSM-283B	Grey	Common Cathode	3.4	6	10	3.3	20	Upper and Lower
<b>7.0 mm (0.28") Dual Digit SMT Display</b>								
<b>AllInGaP Red 624 nm</b> 								
HDSM-291C	Grey	Common Anode	3.4	7.5	10	2	20	Upper and Lower
HDSM-293C	Grey	Common Cathode	3.4	7.5	10	2	20	Upper and Lower
<b>AllInGaP Green 571 nm</b> 								
HDSM-291H	Grey	Common Anode	3.4	6	10	2.1	20	Upper and Lower
HDSM-293H	Grey	Common Cathode	3.4	6	10	2.1	20	Upper and Lower
<b>AllInGaP Yellow 589 nm</b> 								
HDSM-291F	Grey	Common Anode	3.4	8	10	2.1	20	Upper and Lower
HDSM-293F	Grey	Common Cathode	3.4	8	10	2.1	20	Upper and Lower
<b>AllInGaP Orange 605 nm</b> 								
HDSM-291L	Grey	Common Anode	3.4	8.5	10	2.1	20	Upper and Lower
HDSM-293L	Grey	Common Cathode	3.4	8.5	10	2.1	20	Upper and Lower
<b>InGaN Blue 470nm</b> 								
HDSM-291B	Grey	Common Anode	3.4	6	10	3.3	20	Upper and Lower
HDSM-293B	Grey	Common Cathode	3.4	6	10	3.3	20	Upper and Lower



# LED Indicators and Displays

## Surface Mount Seven-Segment Displays—PCB Platform

Part Number	Face Color	Pin Configuration	Intensity (mcd)		I <sub>v</sub> Test Current (mA)	V <sub>f</sub> Typ. (V)	V <sub>f</sub> Test Current (mA)	Decimal Point
			Min.	Typ.				
<b>10 mm (0.39") Single Digit SMT Display</b>								
<b>AllInGaP Red 624 nm</b> 								
HDSM-431C	Grey	Common Anode	8.6	14.3	10	2	20	Right
HDSM-433C	Grey	Common Cathode	8.6	14.3	10	2	20	Right
<b>AllInGaP Green 571 nm</b> 								
HDSM-431H	Grey	Common Anode	5.4	9	10	2.1	20	Right
HDSM-433H	Grey	Common Cathode	5.4	9	10	2.1	20	Right
<b>AllInGaP Yellow 589 nm</b> 								
HDSM-431F	Grey	Common Anode	8.6	15	10	2.1	20	Right
HDSM-433F	Grey	Common Cathode	8.6	15	10	2.1	20	Right
<b>AllInGaP Orange 605 nm</b> 								
HDSM-431L	Grey	Common Anode	8.6	16	10	2.1	20	Right
HDSM-433L	Grey	Common Cathode	8.6	16	10	2.1	20	Right
<b>InGaN Blue 470nm</b> 								
HDSM-431B	Grey	Common Anode	5.4	11.2	10	3.3	20	Right
HDSM-433B	Grey	Common Cathode	5.4	11.2	10	3.3	20	Right
<b>InGaN White</b> 								
HDSM-431W	Grey	Common Anode	24	40	5	2.95	5	Right
HDSM-433W	Grey	Common Cathode	24	40	5	2.95	5	Right
<b>10 mm (0.39") Dual Digit SMT Display</b>								
<b>AllInGaP Red 624 nm</b> 								
HDSM-441C	Grey	Common Anode	8.6	14.3	10	2	20	Right
HDSM-443C	Grey	Common Cathode	8.6	14.3	10	2	20	Right
<b>AllInGaP Green 571 nm</b> 								
HDSM-441H	Grey	Common Anode	5.4	9	10	2.1	20	Right
HDSM-443H	Grey	Common Cathode	5.4	9	10	2.1	20	Right
<b>AllInGaP Yellow 589 nm</b> 								
HDSM-441F	Grey	Common Anode	8.6	15	10	2.1	20	Right
HDSM-443F	Grey	Common Cathode	8.6	15	10	2.1	20	Right
<b>AllInGaP Orange 605 nm</b> 								
HDSM-441L	Grey	Common Anode	8.6	16	10	2.1	20	Right
HDSM-443L	Grey	Common Cathode	8.6	16	10	2.1	20	Right
<b>InGaN Blue 470nm</b> 								
HDSM-441B	Grey	Common Anode	5.4	11.2	10	3.3	20	Right
HDSM-443B	Grey	Common Cathode	5.4	11.2	10	3.3	20	Right
<b>InGaN White</b> 								
HDSM-441W	Grey	Common Anode	24	40	5	2.95	5	Right
HDSM-443W	Grey	Common Cathode	24	40	5	2.95	5	Right

# LED Indicators and Displays



## Surface Mount Seven-Segment Displays—PCB Platform

Part Number	Face Color	Pin Configuration	Intensity (mcd)		Iv Test Current (mA)	Vf Typ. (V)	Vf Test Current (mA)	Decimal Point
			Min.	Typ.				
<b>14.22 mm (0.56") Single Digit SMT Display</b>								
<b>AllInGaP Red 624 nm</b> 								
HDSM-531C	Grey	Common Anode	8.6	16	10	2	20	Right
HDSM-533C	Grey	Common Cathode	8.6	16	10	2	20	Right
<b>AllInGaP Green 571 nm</b> 								
HDSM-531H	Grey	Common Anode	5.4	10.5	10	2.1	20	Right
HDSM-533H	Grey	Common Cathode	5.4	10.5	10	2.1	20	Right
<b>AllInGaP Yellow 589 nm</b> 								
HDSM-531F	Grey	Common Anode	8.6	20	10	2.1	20	Right
HDSM-533F	Grey	Common Cathode	8.6	20	10	2.1	20	Right
<b>AllInGaP Orange 605 nm</b> 								
HDSM-531L	Grey	Common Anode	8.6	19.5	10	2.1	20	Right
HDSM-533L	Grey	Common Cathode	8.6	19.5	10	2.1	20	Right
<b>InGaN Blue 470nm</b> 								
HDSM-531B	Grey	Common Anode	5.4	13.5	10	3.3	20	Right
HDSM-533B	Grey	Common Cathode	5.4	13.5	10	3.3	20	Right
<b>InGaN White</b> 								
HDSM-531W	Grey	Common Anode	28	44	5	2.95	5	Right
HDSM-533W	Grey	Common Cathode	28	44	5	2.95	5	Right
<b>14.22mm (0.56") Dual Digit SMT Display</b>								
<b>AllInGaP Red 624 nm</b> 								
HDSM-541C	Grey	Common Anode	8.6	16	10	2	20	Right
HDSM-543C	Grey	Common Cathode	8.6	16	10	2	20	Right
<b>AllInGaP Green 571 nm</b> 								
HDSM-541H	Grey	Common Anode	5.4	10.5	10	2.1	20	Right
HDSM-543H	Grey	Common Cathode	5.4	10.5	10	2.1	20	Right
<b>AllInGaP Yellow 589 nm</b> 								
HDSM-541F	Grey	Common Anode	8.6	20	10	2.1	20	Right
HDSM-543F	Grey	Common Cathode	8.6	20	10	2.1	20	Right
<b>AllInGaP Orange 605 nm</b> 								
HDSM-541L	Grey	Common Anode	8.6	19.5	10	2.1	20	Right
HDSM-543L	Grey	Common Cathode	8.6	19.5	10	2.1	20	Right
<b>InGaN Blue 470nm</b> 								
HDSM-541B	Grey	Common Anode	5.4	13.5	10	3.3	20	Right
HDSM-543B	Grey	Common Cathode	5.4	13.5	10	3.3	20	Right
<b>InGaN White</b> 								
HDSM-541W	Grey	Common Anode	28	44	5	2.95	5	Right
HDSM-543W	Grey	Common Cathode	28	44	5	2.95	5	Right





# LED Indicators and Displays

## Through-hole Seven-Segment Displays—PCB Platform Luminous Intensity Categories (Typ.)





### 7.62 mm (0.3") Single Digit

Bin ID	Iv in mcd	
	Min.	Max.
<b>GaP Red</b>  HDSP-33xE		
G	0.801	1.250
H	1.251	2.000
I	2.001	3.200
<b>GaP Green</b>  HDSP-33xG		
G	0.801	1.250
H	1.251	2.000
I	2.001	3.200
<b>AlGaAs Red</b>  HDSP-33xA		
I	2.001	3.200
J	3.201	5.050
K	5.051	8.000





### 10.16 mm (0.4") Single Digit

Bin ID	Iv in mcd	
	Min.	Max.
<b>GaP Red</b>  HDSP-31xE		
H	1.251	2.000
I	2.001	3.200
J	3.201	5.050
<b>GaP Green</b>  HDSP-31xG		
H	1.251	2.000
I	2.001	3.200
J	3.201	5.050
<b>AlGaAs Red</b>  HDSP-31xA		
J	3.201	5.050
K	5.051	8.000
L	8.001	12.650
<b>GaP Yellow</b>  HDSP-31xY		
G	0.801	1.250
H	1.251	2.000
I	2.001	3.200





### 13 mm (0.56") Slim Font Single Digit

Bin ID	Iv in mcd	
	Min.	Max.
<b>GaP Red</b>  HDSP-56xE		
I	1.100	2.200
K	1.800	3.600
<b>GaP Green</b>  HDSP-56xG		
K	1.800	3.600
L	2.800	5.600
<b>AlGaAs Red</b>  HDSP-56xA		
F	0.280	0.560
G	0.450	0.900
<b>GaP Yellow</b>  HDSP-56xY		
I	1.100	2.200
K	1.800	3.600

### 10 mm (0.4") Slim Font Single Digit

Bin ID	Iv in mcd	
	Min.	Max.
<b>GaP Red</b>  HDSP-30xE		
I	1.100	2.200
K	1.800	3.600
<b>GaP Green</b>  HDSP-30xG		
K	1.800	3.600
L	2.800	5.600
<b>AlGaAs Red</b>  HDSP-30xA		
F	0.280	0.560
G	0.450	0.900
<b>GaP Yellow</b>  HDSP-30xY		
I	1.100	2.200
K	1.800	3.600





### 10.16 mm (0.4"D) Dual Digit

Bin ID	Iv in mcd	
	Min.	Max.
<b>GaP Red</b>  HDSP-G0xE		
H	1.251	2.000
I	2.001	3.200
J	3.201	5.050
<b>GaP Green</b>  HDSP-G0xG		
H	1.251	2.000
I	2.001	3.200
J	3.201	5.050
<b>AlGaAs Red</b>  HDSP-G0xA		
J	3.201	5.050
K	5.051	8.000
L	8.001	12.650
<b>GaP Yellow</b>  HDSP-G0xY		
G	0.801	1.250
H	1.251	2.000
I	2.001	3.200





# LED Indicators and Displays

## Through-hole Seven-Segment Displays—PCB Platform



### 14.22 mm (0.56") Single Digit

Bin ID	Customer Iv in mcd	
	Min.	Max.
<b>GaP Red</b> 		
HDSP-51xE		
I	2.001	3.200
J	3.201	5.050
K	5.051	8.000
<b>GaP Green</b> 		
HDSP-51xG		
I	2.001	3.200
J	3.201	5.050
K	5.051	8.000
<b>AlGaAs Red</b> 		
HDSP-51xA		
J	3.201	5.050
K	5.051	8.000
L	8.001	12.650
<b>GaP Yellow</b> 		
HDSP-51xY		
H	1.251	2.000
I	2.001	3.200
J	3.201	5.050

### 0.56" Dual Digit

Bin ID	Customer Iv in mcd	
	Min.	Max.
<b>GaP Red</b> 		
HDSP-52xE		
G	2.28	3.42
H	3.42	5.13
I	5.13	7.69
<b>GaP Yellow</b> 		
HDSP-52xY		
F	1.52	2.28
G	2.28	3.42
H	3.42	5.13
<b>GaP Green</b> 		
HDSP-52xG		
G	2.28	3.42
H	3.42	5.13
<b>AlGaAs Red</b> 		
HDSP-52xA		
J	3.201	5.050
K	5.051	8.000
L	8.001	12.650



### 0.8" Single Digit

Bin ID	Customer Iv in mcd	
	Min.	Max.
<b>GaP Red</b> 		
HDSP-81xE		
N	4.78	8.34
P	6.82	11.86
Q	9.7	16.61
<b>GaP Green</b> 		
HDSP-81xG		
P	6.82	11.86
Q	9.7	16.61
R	13.6	23.74



# LED Indicators and Displays

## Surface Mount Seven-Segment Displays





### 10mm (0.28") Single Digit SMT Display

Bin ID	Iv in mcd	
	Min.	Max.
<b>AllInGaP Green</b>  HDSM-281H HDSM-283H		
L	3.401	5.400
M	5.401	8.600
<b>AllInGaP Red/Orange/Yellow</b>  HDSM-281C/281L/281F HDSM-283C/283L/283F		
L	3.401	5.400
M	5.401	8.600
N	8.601	13.700
<b>InGaN Blue</b>  HDSM-281B HDSM-283B		
L	3.401	5.400
M	5.401	8.600
N	8.601	13.700

### 10mm (0.28") Dual Digit SMT Display

Bin ID	Iv in mcd	
	Min.	Max.
<b>AllInGaP Green</b>  HDSM-291H HDSM-293H		
L	3.401	5.400
M	5.401	8.600
<b>GAllInGaP Red/Orange/Yellow</b>  HDSM-291C/291L/291F HDSM-293C/293L/293F		
L	3.401	5.400
M	5.401	8.600
N	8.601	13.700
<b>InGaN Blue</b>  HDSM-291B HDSM-293B		
L	3.401	5.400
M	5.401	8.600
N	8.601	13.700





### 10mm (0.39") Single Digit SMT Display

Bin ID	Iv in mcd	
	Min.	Max.
<b>AllInGaP Green</b>  HDSM-431H HDSM-433H		
M	5.401	8.600
N	8.601	13.700
P	13.701	21.800
<b>AllInGaP Red/Yellow</b>  HDSM-431C/431F HDSM-433C/433F		
N	8.601	13.700
P	13.701	21.800
Q	21.801	34.700
<b>AllInGaP Orange</b>  HDSM-431L HDSM-433L		
N	8.601	13.700
P	13.701	21.800
Q	21.801	34.700
R	34.701	55.200
<b>InGaN Blue</b>  HDSM-431B HDSM-433B		
M	5.401	8.600
N	8.601	13.700
P	13.701	21.800





# LED Indicators and Displays

## Surface Mount Seven-Segment Displays Luminous Intensity Categories (Typ.)





### 10mm (0.39") Dual Digit

Bin ID	Customer Iv in mcd	
	Min.	Max.
<b>AllnGaP Green</b> 		
HDSM-441H HDSM-443H		
M	5.401	8.600
N	8.601	13.700
P	13.701	21.800
<b>AllnGaP Red/Yellow</b> 		
HHDSM-441C/441F HDSM-443C/443F		
N	8.601	13.700
P	13.701	21.800
Q	21.801	34.700
<b>AllnGaP Orange</b> 		
HDSM-441L HDSM-443L		
N	8.601	13.700
P	13.701	21.800
Q	21.801	34.700
R	34.701	55.200
<b>InGaN Blue</b> 		
HDSM-441B HDSM-443B		
M	5.401	8.600
N	8.601	13.700
P	13.701	21.800

### 14.22mm (0.56") Single Digit

Bin ID	Customer Iv in mcd	
	Min.	Max.
<b>AllnGaP Green</b> 		
HDSM-531H HDSM-533H		
M	5.401	8.600
N	8.601	13.700
<b>AllnGaP Red</b> 		
HDSM-531C HDSM-533C		
N	8.601	13.700
P	13.701	21.800
<b>AllnGaP Orange/Yellow</b> 		
HDSM-531L/531F HDSM-533L/533F		
N	8.601	13.700
P	13.701	21.800
Q	21.801	34.700
<b>InGaN Blue</b> 		
HDSM-531B HDSM-533B		
M	5.401	8.600
N	8.601	13.700
P	13.701	21.800
Q	21.801	34.700

### 14.22mm (0.56") Dual Digit

Bin ID	Customer Iv in mcd	
	Min.	Max.
<b>AllnGaP Green</b> 		
HDSM-541H HDSM-543H		
M	5.401	8.600
N	8.601	13.700
<b>AllnGaP Red</b> 		
HDSM-541C HDSM-543C		
N	8.601	13.700
P	13.701	21.800
<b>AllnGaP Orange/Yellow</b> 		
HHDSM-541L/541F HDSM-543L/543F		
N	8.601	13.700
P	13.701	21.800
Q	21.801	34.700
<b>InGaN Blue</b> 		
HDSM-541B HDSM-543B		
M	5.401	8.600
N	8.601	13.700
P	13.701	21.800
Q	21.801	34.700

# LED Indicators and Displays

## Through-hole Seven-Segment Displays—Leadframe Platform

### 7.6 mm (0.3") Micro Bright Displays Package Dimension

Part Number		
HDSP-	A151	A211
	7501	A213
	A401	A511
	A411	A513
	7401	
	7801	
	A153	
	7503	
	A403	
	A413	
	7403	
	7803	

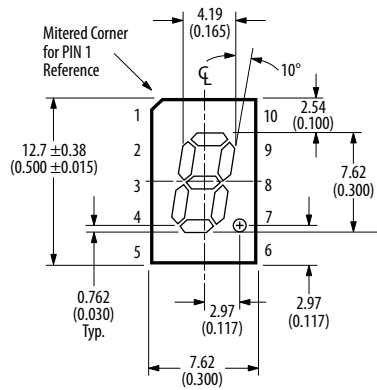

### 7.6 mm (0.3") Micro Bright Overflow Displays (Right Decimal Point) Package Dimension

Part Number		
HDSP-	7507	
	A407	
	7407	
	7807	
	7508	
	A408	
	7408	
	7808	

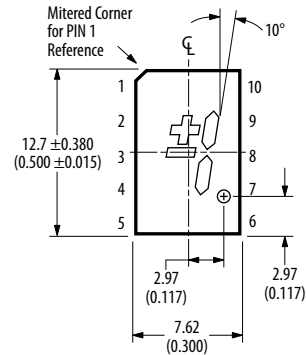

### 7.6 mm (0.3") Micro Bright Low Current Displays (Right Decimal Point) Package Dimension

Part Number		
HDSP-	A101	A111
	7511	A113
	A801	
	A901	
	A103	
	7513	
	A803	
	A903	

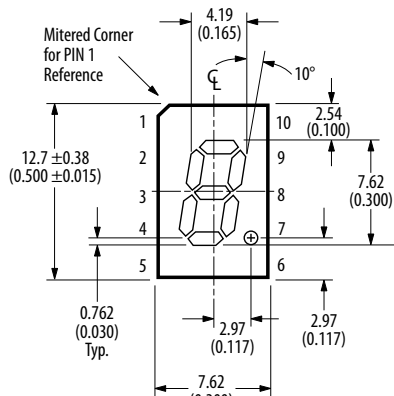

### 7.6 mm (0.3") Single Digit Displays Package Dimension

Part Number		
5082-	7610	
	7611	
	7613	
	7620	
	7621	
	7623	
	3600	
	3601	
	3603	

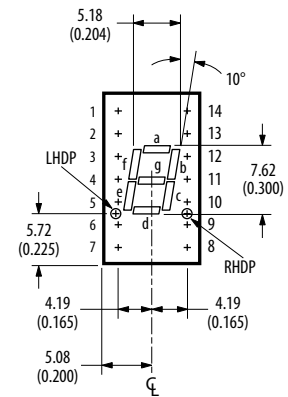

### 8 mm (0.31") Micro Bright Displays Package Dimension

Part Number		
HDSP-	Uxxx	

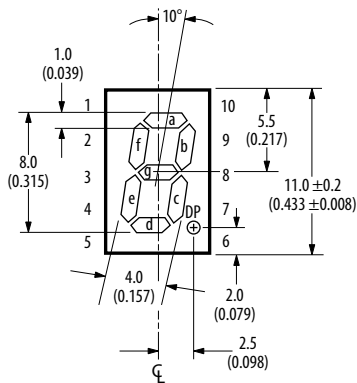

### 10 mm (0.4") Single Digit Displays (Right Decimal Point) Package Dimension

Part Number		
HDSP-	F111	F113
	F211	F213
	F511	F513
	F101	F103
	F201	F203
	F401	F403
	F411	F413
	F301	F303
	F501	F503
	F511	F513

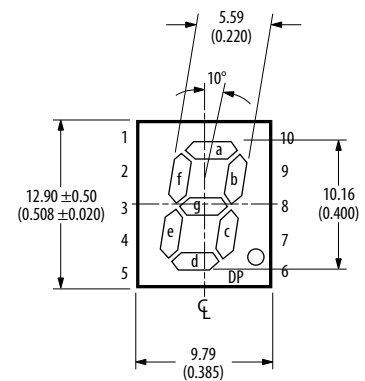

Note:  
1. Dimensions in millimeters (inches).

# LED Indicators and Displays

## Through-hole Seven-Segment Displays—Leadframe Platform

### 10 mm (0.4") Overflow Displays (Right Decimal Point) Package Dimension

Part Number		
HDSP-	F107	F108
	F207	F208
	F407	F408
	F307	F308
	F507	F508

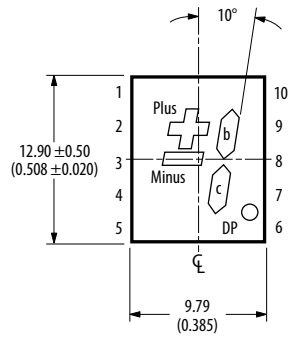

### 10.9 mm (0.43") Single Digit Displays (Right Decimal Point) Package Dimension

Part Number		
HDSP-	E101	E103
	3351	3353
5082-	7651	7653
	7661	7663
	4601	4603

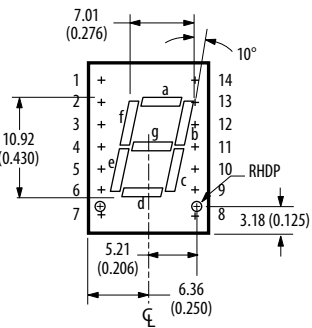

Part Number	
5802-	7650
	7660
	4600

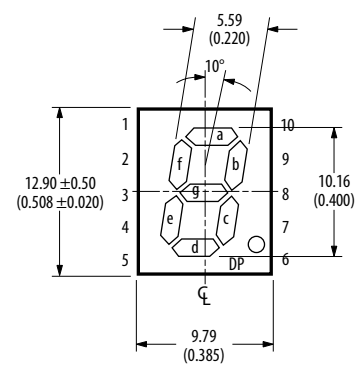

### 10.9 mm (0.43") Overflow Displays Package Dimension

Part Number		
HDSP-	4606	
	5082-	7656
		7666

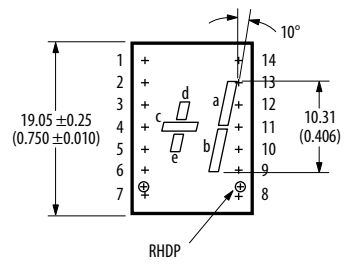

Part Number	
HDSP-	3356

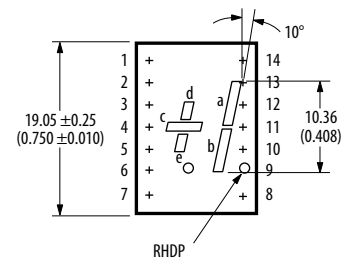

### 14.2 mm (0.56") Single Digit Displays (Right Decimal Point) Package Dimension

Part Number		
HDSP-	H111	H211
	H411	H511
	H113	H213
	H413	H513
	H101	H103
	H401	H403
	5551	5553
	5501	5503
	5701	5703
	5601	5603

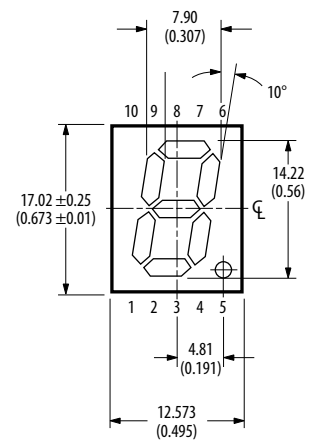

Note:  
1. Dimensions in millimeters (inches).



# LED Indicators and Displays

## Through-hole Seven-Segment Displays—Leadframe Platform

### 14.2 mm (0.56") Overflow Displays (Right Decimal Point) Package Dimension

Part Number		
HDSP-	H107	H108
	H407	H408
	5557	5558
	5507	5508
	5707	5708
	5607	5608

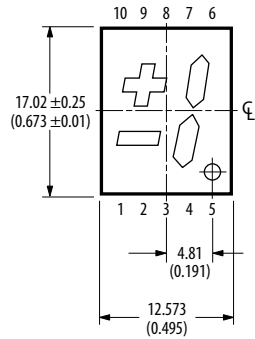

### 14.22 mm (0.56") Single Digit Displays Package Dimension

Part Number		
HDSP-	51xE	51xG
	51xA	51xY

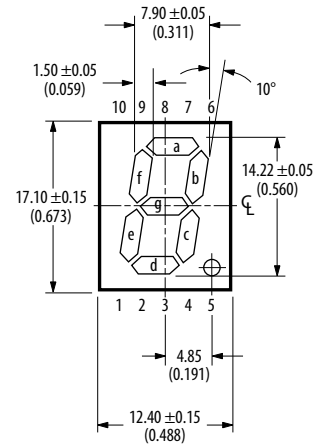

### 20 mm (0.8") Single Digit Displays Package Dimension

Part Number		
HDSP-	3901	3903
	4201	4203
	8601	8603
	N101	N103
	N401	N403

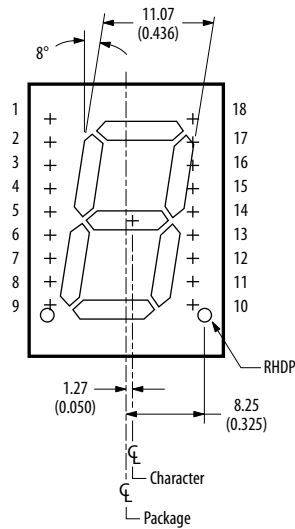

Part Number		
HDSP-		N105
	3900	3905
	4200	4205
	8600	8605

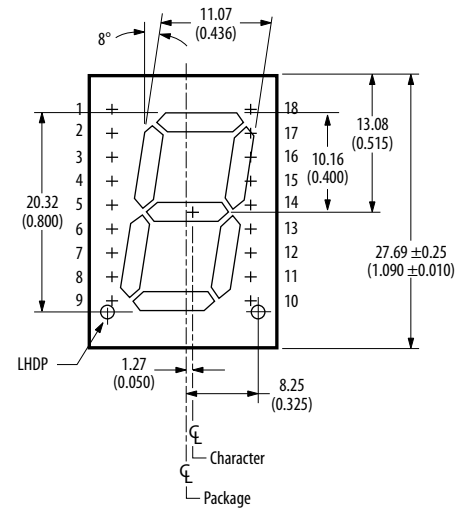

## Through-hole Seven Segment Displays—PCB Platform

### 7.62 mm (0.3") Single Digit Displays Package Dimension

Part Number	
HDSP-	333E
	333G
	333A

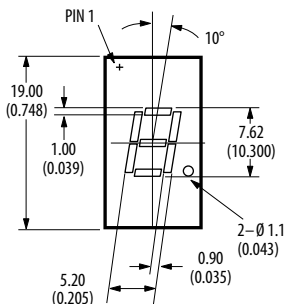

Note:  
1. Dimensions in millimeters (inches).

# LED Indicators and Displays

## Through-hole Seven-Segment Displays—Leadframe Platform

### 10 mm (0.4") Slim Font Single Digit Displays (Right Decimal Point) Package Dimension

Part Number		
HDSP-	30xE	30xG
	30xA	30xY

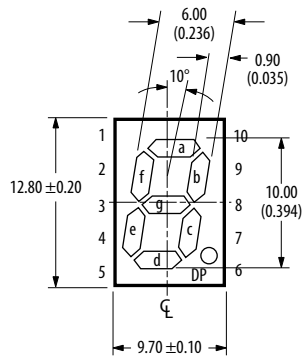

### 10.16 mm (0.4") Dual Digit Displays Package Dimension

Part Number		
HDSP-	G0xE	G0xG
	G0xA	G0xY

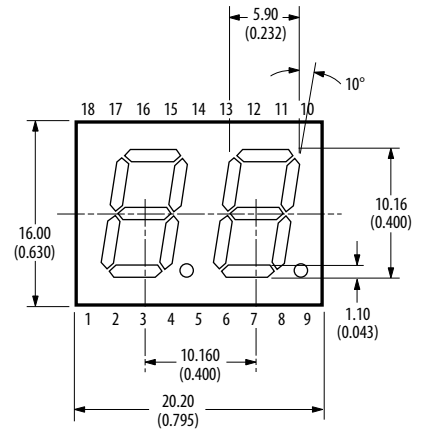

## Through-hole Seven Segment Displays—PCB Platform

### 9.1mm (0.36") Single Digit Displays Package Dimension

Part Number	
HDSP-	C3A1
	C3A3
	C3E1
	C3E3

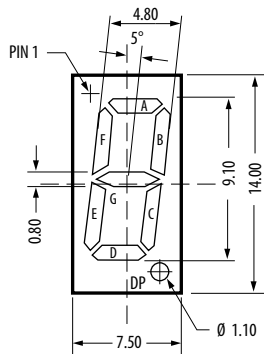

### 10.16 mm (0.4") Single Digit Displays Package Dimension

Part Number	
HDSP-	311E
	311G
	311A
	311Y

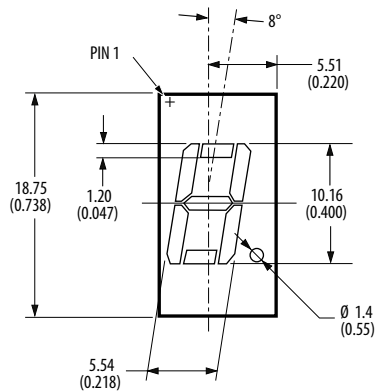

Part Number	
HDSP-	313E
	313G
	313A
	313Y

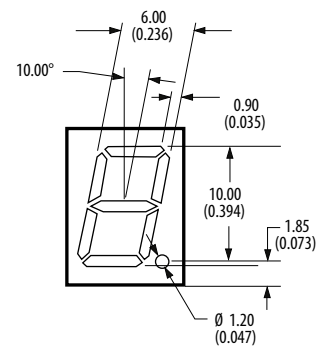

**Note:**

1. Dimensions in millimeters (inches).

# LED Indicators and Displays

## Through-hole Seven Segment Displays—PCB Platform

### 13.1mm (0.52") Single Digit Displays Package Dimension

Part Number	
HDSP-	CSA1
	CSA3

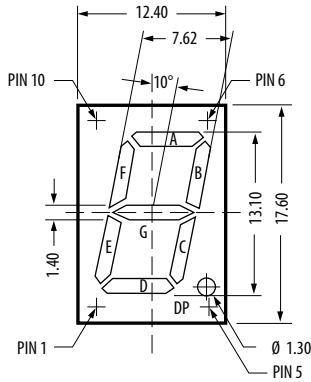

### 14.2 mm (0.56") Dual Digit Displays Package Dimension

Part Number		
HDSP-	52xA	52xE
	52xG	52xY

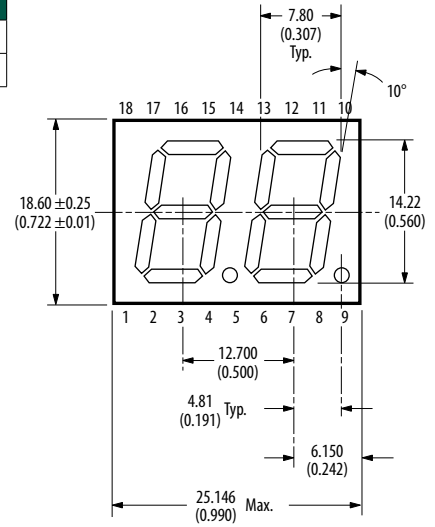

### 20 mm (0.8") Single Digit Displays Package Dimension

Part Number		
HDSP-	81xE	81xG

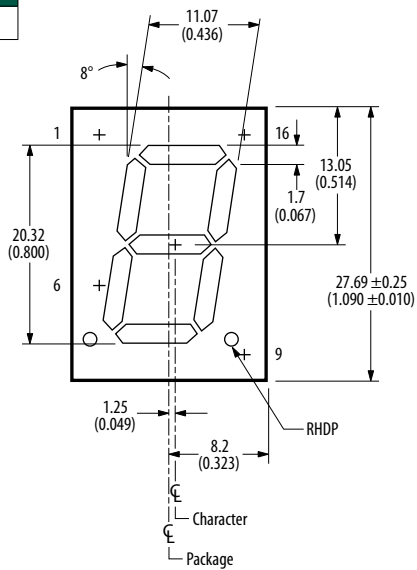

Part Number	
HDSP-	C8A1
	C8A3
	C8E1
	C8E3
	C8L1
	C8L3
	C8G1
	C8G3

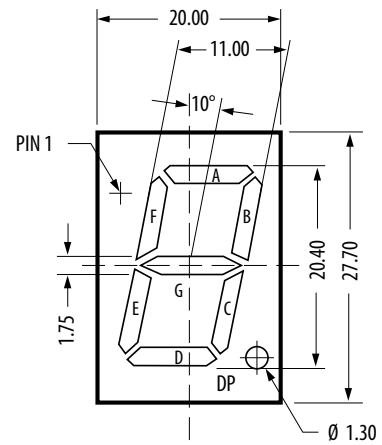

Note:  
1. Dimensions in millimeters (inches).

# LED Indicators and Displays

## Surface Mount Seven Segment Displays — PCB Platform

### 7.0mm (0.28") Single Digit SMT Display Package Dimension

Part Number	
HDSM-	281C
	281B
	283B
	283C
	281H
	283H
	281F
	283F
	281L
	283L

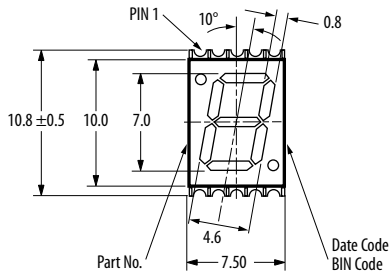

### 10.0mm (0.39") Dual Digit SMT Display Package Dimension

Part Number	
HDSM-	441C
	441B
	443B
	441W
	443W
	443C
	441H
	443H
	441F
	443F
	441L
	443L

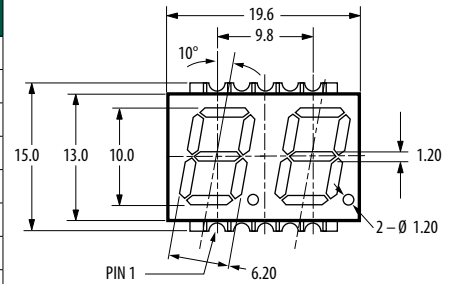

### 7.0mm (0.28") Dual Digit SMT Display Package Dimension

Part Number	
HDSM-	291C
	291B
	293B
	293C
	291H
	293H
	291F
	293F
	291L
	293L

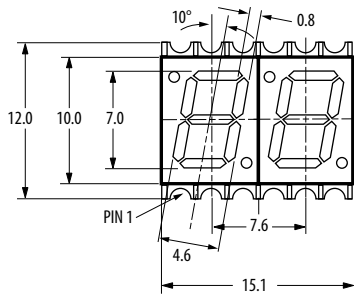

### 10mm (0.39") Single Digit SMT Display Package Dimension

Part Number	
HDSM	431C
	431B
	433B
	431W
	433W
	433C
	431H
	433H
	431F
	433F
	431L
	433L

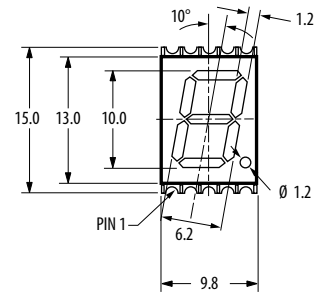

### 14.22mm (0.56") Single Digit SMT Display Package Dimension

Part Number	
HDSM	531C
	531B
	533B
	531W
	533W
	533C
	531H
	533H
	531F
	533F
	531L
	533L

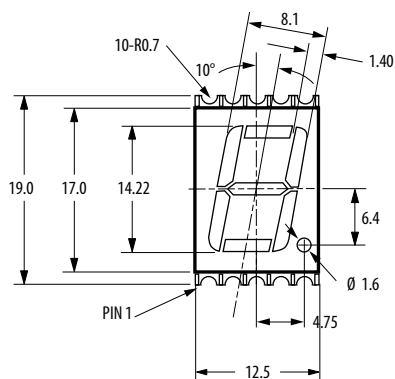

### 14.22mm (0.56") Dual Digit SMT Display Package Dimension

Part Number	
HDSM-	541C
	541B
	543B
	541W
	543W
	543C
	541H
	543H
	541F
	543F
	541L
	543L

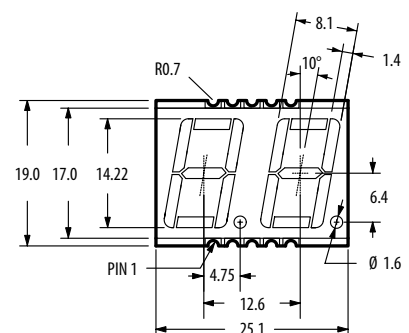

**Note:**

1. Dimensions in millimeters (inches).

## Light Bars and Bar Graph Arrays

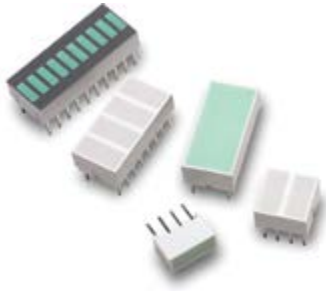

### Description — Light Bars

Light Bars are Avago Technologies' innovative solution to fixed message annunciator. They are used as annunciators that serve three customer functions: status indication, backlighting fixed messages and analog level indications (arrays). The Light Bars provide exceptional brightness at very low drive current for those applications where portability and battery backup are vital. These rectangular light sources are configured in single-in-line and dual-in-line packages that contain either single or segmented light emitting areas. They are also X-Y stackable.

### Features & Benefits

- Large, bright, uniform light emitting surface
- Yellow and green categorized for dominant wavelength
- Low heat dissipation
- Choices of colors — Red, Green, Yellow
- Various package sizes are X-Y stackable
- Industry standard SIP and DIP packages

### Typical Applications

- Business machines
  - Point of sale bar code scanner
  - Electronic typewriters
  - Fax machines
  - Electronic scales
  - Postal meters
- Instrumentation
  - Process control system
  - Medical equipment
  - Machine control systems
  - Meters and status indicators
- Telecommunications
  - PBX systems
  - Modems
  - Central switching systems
  - Diagnostic equipment
  - Short wave radios
- Transportation
  - Automotive dashboards
  - Truck and bus controls
  - Airport passenger metal detectors
  - Ticket vending machines
- Consumer
  - Appliance front panel
  - Hi-Fi/stereo equipment
  - Alarm system

### Description — 10-Element Bar Graph Arrays

Avago Technologies' 10-Element Bar Graph Arrays serve a market need for analog level indication. LED reliability, light emitting viewability make them suitable in place of mechanical meters. They are designed to display information in easily recognizable bar graph form. The packages are end stackable and are therefore capable of displaying long strings of information. The bar graph arrays are precision matched for both intensity and wavelength, saving you the time and trouble of matching individual parts. The prealigned bar graph elements locked in a single package eliminates the task of matching and aligning individual LEDs during manufacturing, along with the risk of visually substandard front panels resulting from misaligned indicators. Each device offers easy-to-handle packages that are compatible with standard DIP sockets.

### Features & Benefits

- Exclusive package interlock
  - Facilitate end stacking alignment
- Large segment size
  - Wide viewing angle
- Available in Red, Green, Yellow and multicolor
- Wide variety of applications
- Categorized and packaged for luminous intensity
  - Greater uniformity of light output
- Matched LEDs for uniform appearance

### Typical Applications

- Instrumentation
  - Meters
  - Channel indicators
  - Status indicators
- Process control
  - Level indicators
- Appliances
  - Status of indication
  - Mode of operation
- Transportation
  - Tachometers
  - Fuel gauges
- Consumer products
  - VU meters (stereos)
  - Radio channel scanners
  - Burglar alarms

# LED Indicators and Displays

## Light Bars

Shape	Size/# Light Emitting	Part Number	Color	Chip (nm) Typ.	Vf (V) Typ.	Vf (V) at If = mA	Iv at If = mA	Iv Typ. (mcd)
0.4SIP	0.35" x 0.15" 1 area	HLCP-A100	AlGaAs Red	637	1.8	20	3	7.5
0.4SIP	0.35" x 0.15" 1 area	HLMP-2300	GaP Red	626	2	20	20	23
0.4SIP	0.35" x 0.15" 1 area	HLMP-2400	GaP Yellow	585	2.1	20	20	20
0.4SIP	0.35" x 0.15" 1 area	HLMP-2500	GaP Green	572	2.2	20	20	25
0.8SIP	0.75" x 0.15" 1 area	HLCP-B100	AlGaAs Red	637	1.8	20	3	15
0.8SIP	0.75" x 0.15" 1 area	HLMP-2350	GaP Red	626	2	20	20	45
0.8SIP	0.75" x 0.15" 1 area	HLMP-2450	GaP Yellow	585	2.1	20	20	38
0.8SIP	0.75" x 0.15" 1 area	HLMP-2550	GaP Green	572	2.2	20	20	50
0.4DIP	0.35" x 0.35" 1 area	HLCP-C100	AlGaAs Red	637	1.8	20	3	15
0.4DIP	0.35" x 0.35" 1 area	HLMP-2655	GaP Red	626	2	20	20	45
0.4DIP	0.35" x 0.35" 1 area	HLMP-2755	GaP Yellow	585	2.1	20	20	38
0.4DIP	0.35" x 0.35" 1 area	HLMP-2855	GaP Green	572	2.2	20	20	50
0.4DIP	0.35" x 0.15" 2 areas	HLCP-D100	AlGaAs Red	637	1.8	20	3	7.5
0.4DIP	0.35" x 0.15" 2 areas	HLMP-2600	GaP Red	626	2	20	20	23
0.4DIP	0.35" x 0.15" 2 areas	HLMP-2700	GaP Yellow	585	2.1	20	20	20
0.4DIP	0.35" x 0.15" 2 areas	HLMP-2800	GaP Green	572	2.1	20	20	25
0.8DIP	0.35" x 0.15" 4 areas	HLCP-E100	AlGaAs Red	637	1.8	20	3	7.5
0.8DIP	0.35" x 0.15" 4 areas	HLMP-2620	GaP Red	626	2	20	20	23
0.8DIP	0.35" x 0.15" 4 areas	HLMP-2720	GaP Yellow	585	2.1	20	20	20
0.8DIP	0.35" x 0.15" 4 areas	HLMP-2820	GaP Green	572	2.2	20	20	25
0.8DIP	0.15" x 0.75" 2 areas	HLCP-F100	AlGaAs Red	637	1.8	20	3	15
0.8DIP	0.15" x 0.75" 2 areas	HLMP-2635	GaP Red	626	2	20	20	45
0.8DIP	0.15" x 0.75" 2 areas	HLMP-2735	GaP Yellow	585	2.1	20	20	38
0.8DIP	0.15" x 0.75" 2 areas	HLMP-2835	GaP Green	572	2.2	20	20	50
0.8DIP	0.35" x 0.35" 2 areas	HLCP-G100	AlGaAs Red	637	1.8	20	3	15
0.8DIP	0.35" x 0.35" 2 areas	HLMP-2670	GaP Red	626	2	20	20	45
0.8DIP	0.35" x 0.35" 2 areas	HLMP-2770	GaP Yellow	585	2.1	20	20	38
0.8DIP	0.35" x 0.35" 2 areas	HLMP-2870	GaP Green	572	2.2	20	20	50
0.8DIP	0.35" x 0.75" 1 areas	HLCP-H100	AlGaAs Red	637	1.8	20	3	30
0.8DIP	0.35" x 0.75" 1 areas	HLMP-2685	GaP Red	626	2	20	20	80
0.8DIP	0.35" x 0.75" 1 areas	HLMP-2785	GaP Yellow	585	2.1	20	20	70
0.8DIP	0.35" x 0.75" 1 areas	HLMP-2885	GaP Green	572	2.2	20	20	100

# LED Indicators and Displays

## Bicolor Light Bars







Shape	Size/# Light Emitting	Part Number	Color	Chip (nm) Typ.	Vf (V) Typ.	Vf (V) at If = mA	Iv at If = mA	Iv Typ. (mcd)
0.4DIP	0.35" x 0.35" 1 area	HLMP-2950	GaP Red	626	2	20	20	45
			GaP Yellow	585	2.1	20	20	38
0.4DIP	0.35" x 0.35" 1 area	HLMP-2965	GaP Red	626	2	20	20	45
			GaP Green	572	2.2	20	20	50



## Bar Graph Arrays

10 Element	HLCP-J100	AlGaAs Red	637	1.6	1	1	1000
	HDSP-4830	GaP Red	626	2.1	20	10	3500
	HDSP-4840	GaP Yellow	585	2.2	20	10	1900
	HDSP-4850	GaP Green	572	2.1	10	10	1900
Multicolor LA	HDSP-4832	GaP Red	626	2.1	20	10	3500
		GaP Yellow	585	2.2	20	10	1900
		GaP Green	572	2.1	10	10	1900
	HDSP-4836	GaP Red	626	2.1	20	10	3500
		GaP Yellow	585	2.2	20	10	1900
		GaP Green	572	2.1	10	10	1900
		GaP Yellow	585	2.2	20	10	1900
		GaP Red	626	2.1	20	10	3500





## Luminous Intensity Categories

### LED Light Bars





Bin ID	Customer Iv in mcd	
	Min.	Max.
AlGaAs Red  HLCP-A100 / D100 / E100 GaP Red  HLMP-2300 / 2600 / 2620		
B	4.5	8.2
C	6.8	12.1
D	10.1	18.5
E	15.3	27.8
F	22.8	45.5
AlGaAs Red  HLCP-B100 / C100 / F100 / G100 GaP Red  HLMP-2350 / 2635 / 2655 / 2670		
B	9.0	16.0
C	13.1	24.0
D	19.7	36.1
E	29.6	54.2
F	44.9	88.8
AlGaAs Red  HLCP-H100 GaP Red  HLMP-2685		
B	18.0	27.1
C	22.0	40.8
D	33.3	61.1
E	50.0	91.8
F	75.1	150.0

Bin ID	Customer Iv in mcd	
	Min.	Max.
GaP Yellow  HLMP-2400 / 2700 / 2720		
E	13.8	25.3
F	20.7	41.4
HLMP-2450 / 2735 / 2755 / 2770		
E	27.0	50.0
F	40.5	81.0
HLMP-2785		
E	54.0	99.0
F	81.0	162.0
GaP Green  HLMP-2500 / 2800 / 2820		
F	18.9	37.8
G	30.6	61.2
HLMP-2550 / 2835 / 2855 / 2870		
F	38.1	76.2
G	61.6	123.2
HLMP-2885		
F	75.1	150.3
G	121.1	242.2

### Bicolor Light Bars

Bin ID	Customer Iv in mcd	
	Min.	Max.
HLMP-2950/GaP Red 		
D	17.00	31.00
E	25.40	46.50
F	38.10	76.20
GaP Yellow 		
D	18.00	33.00
E	27.00	50.00
F	40.50	81.00
HLMP-2965/GaP Red 		
F	44.90	88.80
G	71.90	143.80
GaP Green 		
F	38.10	76.20
G	61.60	123.20

### Bar Graph Arrays

Bin ID	Customer Iv in mcd	
	Min.	Max.
AlGaAs Red / HLCP-J100  GaP Red/GaP Yellow/GaP Green    HDSP-4830 / 4840 / 4850		
D	0.61	1.11
E	0.91	1.67
F	1.37	2.51
G	2.05	3.76
H	3.08	5.64
I	4.62	8.64

# LED Indicators and Displays

## LED Light Bar and Bar Graph Array Package Dimension Drawings

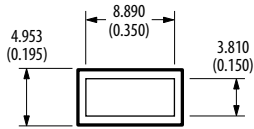

**HLCP-A100**  
HLMP-2300/2400/2500

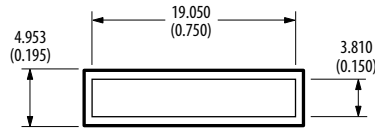

**HLCP-B100**  
HLMP-2x50

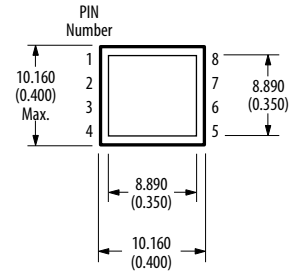

**HLCP-C100**  
HLMP-2x55

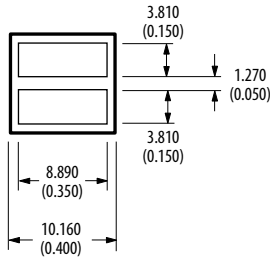

**HLCP-D100**  
HLMP-2600/2700/2800

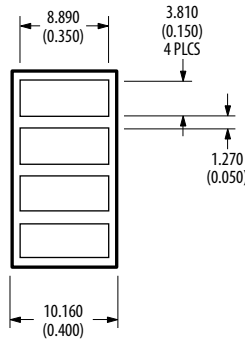

**HLCP-E100**  
HLMP-2x20

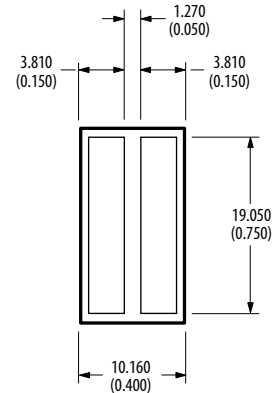

**HLCP-F100**  
HLMP-2x35

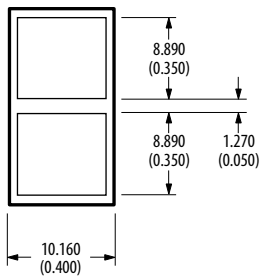

**HLCP-G100**  
HLMP-2x70

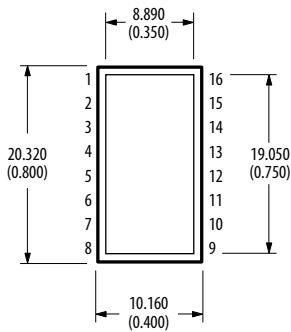

**HLCP-H100**  
HLMP-2x85

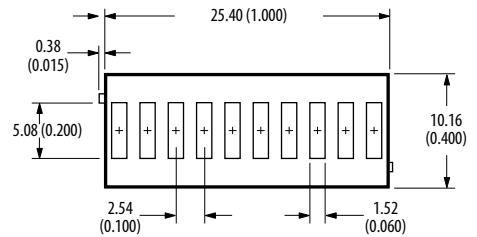

**HLCP-J100**  
HDSF-48x0

**Note:**  
1. Dimensions in millimeters (inches).



## Smart Displays

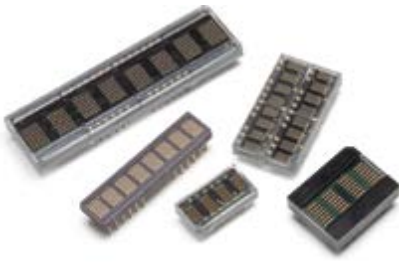

### Description

Avago Technologies offers high quality Smart Displays to meet a wide range of applications and requirements. The Smart Displays are available in both serial and parallel interface and have an ASIC driver that greatly simplifies design efforts. The Smart Displays are LED technology-based and are extremely reliable with a long life expectancy. They are resistant to extreme weather conditions, and to mechanical vibration and shock, making them suitable for industrial applications where maintenance resources are scarce. They are also suitable for the consumer market where the need for aesthetics and product differentiation provides a competitive advantage to our customers' end products. Avago Technologies' Smart Display products are positioned to support high volume and cost-effective solutions.

### Features and Benefits

- Robust design for high reliability, longer life and hot and cold temperature operating capability
  - Ideally suited for outdoor, industrial and automotive applications
- Alphanumeric characters and custom icons for messaging
  - Useful for conveying operating modes, status, warning and error codes
- Ability to flash or blink
  - Catch user's attention
- ASIC LED driver
  - Simplified design interfacing reduces design cycle time
- Emissive display with brightness control
  - Ability to modify brightness for subdued light environment and total darkness
- Aesthetically pleasing
  - Distinctive display allows product differentiation

### Typical Applications

- Industrial Equipment
  - Industrial ovens, reliability test equipment, analytical instruments, process control equipment, test and measuring instruments, temperature controllers, programmable logic controllers, security systems
- Networking
  - Telecommunication equipment, answering machines, telephones, base stations, PBX modems, network cards
- Outdoor Signs
  - Petrol pump meters
- Consumer
  - Audio/video equipment, audio mixers, set top boxes, amplifiers, musical instruments, gaming machines, currency/coin counters, security systems
- Consumer "White Goods"
  - Displays for washing machine digital panels, cookers, freezers and dishwashers
- Medical Equipment
  - Hospital monitoring systems
- Transportation
  - Displays, radar detectors, avionics displays
- Computers and Peripherals
  - CPU speed indicator, printer front panels, fax machines, copy machines, power supply equipment, cash registers

# LED Indicators and Displays

## Plastic Package, Serial Interface, 5 x 7 Dot Matrix Display with Custom Font Programmable

Part Number	Character	Color	Interface	Character Height (mm)	Intensity, Typ. ( $\mu\text{cd}$ )	Supply, Typ. (mA)
HCMS-2901	4	Yellow	Serial	3.7	180	132
HCMS-2902	4	Red	Serial	3.7	270	132
HCMS-2903	4	Green	Serial	3.7	270	132
HCMS-2904	4	Orange	Serial	3.7	180	132
HCMS-2905	4	Deep Red	Serial	3.7	590	145
HCMS-2911	8	Yellow	Serial	3.7	180	264
HCMS-2912	8	Red	Serial	3.7	270	264
HCMS-2913	8	Green	Serial	3.7	270	264
HCMS-2914	8	Orange	Serial	3.7	180	264
HCMS-2915	8	Deep Red	Serial	3.7	590	290
HCMS-2819	8	Blue	Serial	3.7	170	264
HCMS-2921	16	Yellow	Serial	3.7	180	528
HCMS-2922	16	Red	Serial	3.7	270	528
HCMS-2923	16	Green	Serial	3.7	270	528
HCMS-2924	16	Orange	Serial	3.7	180	528
HCMS-2925	16	Deep Red	Serial	3.7	590	580
HCMS-2961	4	Yellow	Serial	4.6	180	132
HCMS-2962	4	Red	Serial	4.6	270	132
HCMS-2963	4	Green	Serial	4.6	270	132
HCMS-2964	4	Orange	Serial	4.6	180	132
HCMS-2965	4	Deep Red	Serial	4.6	590	145
HCMS-2971	8	Yellow	Serial	4.6	180	264
HCMS-2972	8	Red	Serial	4.6	270	264
HCMS-2973	8	Green	Serial	4.6	270	264
HCMS-2974	8	Orange	Serial	4.6	180	264
HCMS-2975	8	Deep Red	Serial	4.6	590	290
HCMS-3901	4	Yellow	Serial	3.7	148	132
HCMS-3902	4	Red	Serial	3.7	64	132
HCMS-3903	4	Green	Serial	3.7	252	132
HCMS-3904	4	Orange	Serial	3.7	64	132
HCMS-3906	4	Red	Serial	3.7	1150	132
HCMS-3907	4	Green	Serial	3.7	500	132
HCMS-3911	8	Yellow	Serial	3.7	148	264
HCMS-3912	8	Red	Serial	3.7	64	264
HCMS-3913	8	Green	Serial	3.7	252	264
HCMS-3914	8	Orange	Serial	3.7	64	264
HCMS-3916	8	Red	Serial	3.7	1150	264
HCMS-3917	8	Green	Serial	3.7	500	264
HCMS-3961	4	Yellow	Serial	4.6	148	132
HCMS-3962	4	Red	Serial	4.6	64	132
HCMS-3963	4	Green	Serial	4.6	252	132
HCMS-3964	4	Orange	Serial	4.6	64	132
HCMS-3966	4	Red	Serial	4.6	1150	132
HCMS-3967	4	Green	Serial	4.6	500	132
HCMS-3971	8	Yellow	Serial	4.6	148	264
HCMS-3972	8	Red	Serial	4.6	64	264
HCMS-3973	8	Green	Serial	4.6	252	264
HCMS-3974	8	Orange	Serial	4.6	64	264
HCMS-3976	8	Red	Serial	4.6	1150	264
HCMS-3977	8	Green	Serial	4.6	500	264

**Notes:**

Typical values at  $T^A = 25^{\circ}\text{C}$ .

Luminous intensity for one pixel at  $V^{\text{LED}} = 5.0\text{V}$ , 50% peak pixel current, 100% pulse width.

Supply current at  $V^{\text{LED}} = 5.0\text{V}$ , 100% peak pixel current, 100% pulse width, 20 pixels per digit at all digit locations.

# LED Indicators and Displays

## Plastic Package, Serial Interface, 5 x 7 Dot Matrix Display with Custom Font Programmable

Part Number	Character	Color	Interface	Character Height (mm)	Intensity, Typ. ( $\mu\text{cd}$ )	Supply, Typ. (mA)
HDLY-1414	4	Yellow	Parallel	3.6	3.7	110
HDLO-1414	4	Red	Parallel	3.6	3.5	110
HDLG-1414	4	Green	Parallel	3.6	5.6	110
HDLA-1414	4	Orange	Parallel	3.6	3.5	110
HDLU-1414	4	Deep Red	Parallel	3.6	3.1	34
HDLS-1414	4	Deep Red	Parallel	3.6	12.7	125
HDLY-2416	4	Yellow	Parallel	5.1	3.7	110
HDLO-2416	4	Red	Parallel	5.1	3.5	110
HDLG-2416	4	Green	Parallel	5.1	5.6	110
HDLA-2416	4	Orange	Parallel	5.1	3.5	110
HDLU-2416	4	Deep Red	Parallel	5.1	3.1	34
HDLS-2416	4	Deep Red	Parallel	5.1	12.7	125
HDLY-3416	4	Yellow	Parallel	6.9	3.7	110
HDLO-3416	4	Red	Parallel	6.9	3.5	110
HDLG-3416	4	Green	Parallel	6.9	5.6	110
HDLA-3416	4	Orange	Parallel	6.9	3.5	110

## Plastic Package, Parallel Interface, 8 Character, 5 x 7 Dot Matrix Display with 128 Character ASCII Decoder

Part Number	Character	Color	Interface	Character Height (mm)	Intensity, Typ. ( $\mu\text{cd}$ )	Supply, Typ. (mA)
HDSP-2530	8	Orange	Parallel	4.6	7.5	300
HDSP-2531	8	Yellow	Parallel	4.6	7.	300
HDSP-2532	8	Red	Parallel	4.6	7.5	300
HDSP-2533	8	Green	Parallel	4.6	7.5	300
HDSP-2534	8	Deep Red	Parallel	4.6	15	330
HDSP-2110	8	Orange	Parallel	4.8	7.5	300
HDSP-2111	8	Yellow	Parallel	4.8	7.5	300
HDSP-2112	8	Red	Parallel	4.8	7.5	300
HDSP-2113	8	Green	Parallel	4.8	7.5	300
HDSP-2107	8	Deep Red	Parallel	4.8	15	330
HDSP-2500	8	Orange	Parallel	7.0	7.5	300
HDSP-2501	8	Yellow	Parallel	7.0	7.5	300
HDSP-2502	8	Red	Parallel	7.0	7.5	300
HDSP-2503	8	Green	Parallel	7.0	7.5	300
HDSP-2504	8	Deep Red	Parallel	7.0	1.5	330

**Notes:**

Typical values at  $V_{DD} = 5.0V$ ,  $T_A = 25^\circ\text{C}$ .

Luminous intensity at 100% full brightness, character average with “#” (20 pixels) displayed.

Supply current at 100% brightness, with all character locations displaying “#” (20 pixels).

# LED Indicators and Displays

## Glass/Ceramic Package, Parallel Interface, 8 Character, 5 x 7 Dot Matrix with 128 Character ASCII Decoder

Part Number	Character	Color	Interface	Character Height (mm)	Intensity, Typ. (μcd)	Supply, Typ. (mA)
HDSP-2131	8	Yellow	Parallel	4.8	7.5	300
HDSP-2132	8	Red	Parallel	4.8	7.5	300
HDSP-2133	8	Green	Parallel	4.8	7.5	300
HDSP-2179	8	Orange	Parallel	4.8	7.5	300

**Notes:**

Typical values at  $V_{DD} = 5.0V$ ,  $T_A = 25^\circ C$ .

Luminous intensity at 100% full brightness, character average with “#” (20 pixels) displayed.

Supply current at 100% brightness, with all character locations displaying “#” (20 pixels).

## Glass/Ceramic Package, 4 x 7 Hexadecimal Display with Built-in BCD Decoder/Driver

Part Number	Description/Decimal Point	Color	Operation Temperature (°C)	Character Height (mm)	Luminous Intensity Typ. (μcd)	Supply Current Typ. (mA)
HDSP-0760	Numeric, RHDP	HER	-55 to 85	7.4	140	78
HDSP-0761	Numeric, LHDP	HER	-55 to 85	7.4	140	78
HDSP-0762	Hexadecimal	HER	-55 to 85	7.4	140	78
HDSP-0770	Numeric, RHDP	HER	-55 to 85	7.4	620	120
HDSP-0771	Numeric, LHDP	HER	-55 to 85	7.4	620	120
HDSP-0772	Hexadecimal	HER	-55 to 85	7.4	620	120
HDSP-0781	Numeric, RHDP	HER	-55 to 100	7.4	140	78
HDSP-0782	Numeric, LHDPi	HER	-55 to 100	7.4	140	78
HDSP-0784	Hexadecimal	HER	-55 to 100	7.4	140	78
HDSP-0791	Numeric, RHDP	HER	-55 to 100	7.4	620	120
HDSP-0792	Numeric, LHDP	HER	-55 to 100	7.4	620	120
HDSP-0794	Hexadecimal	HER	-55 to 100	7.4	620	120
HDSP-0860	Numeric, RHDP	Yellow	-55 to 85	7.4	490	120
HDSP-0861	Numeric, LHDP	Yellow	-55 to 85	7.4	490	120
HDSP-0862	Hexadecimal	Yellow	-55 to 85	7.4	490	120
HDSP-0881	Numeric, RHDP	Yellow	-55 to 100	7.4	490	120
HDSP-0884	Hexadecimal	Yellow	-55 to 100	7.4	490	120
HDSP-0960	Numeric, RHDP	Green	-55 to 85	7.4	1100	120
HDSP-0961	Numeric, LHDP	Green	-55 to 85	7.4	1100	120
HDSP-0962	Hexadecimal	Green	-55 to 85	7.4	1100	120
HDSP-0981	Numeric, RHDP	Green	-55 to 100	7.4	1100	120
HDSP-0984	Hexadecimal	Green	-55 to 100	7.4	1100	120

**Notes:**

Typical values at  $V_{DD} = 5.0V$ ,  $T_A = 25^\circ C$ .

Luminous intensity per LED (Digit Average).

Supply current with “5” or “B” character displayed.

## Glass/Ceramic Package Over Range ± with Built-in BCD Decoder/Driver

Part Number	Description/Decimal Point	Color	Operation Temperature (°C)	Character Height (mm)	Luminous Intensity Typ. (μcd)	Supply Current Typ. (mA)
HDSP-0763	Overrange ± 1	HER	-55 to 85	7.4	140	11.2
HDSP-0863	Overrange ± 1	Yellow	-55 to 85	7.4	490	32
HDSP-0963	Overrange ± 1	Green	-55 to 85	7.4	1100	32
HDPS-0783	Overage ± 1	HER	-55 to 100	7.4	140	11.2
HDPS-0883	Overage ± 1	Yellow	-55 to 100	7.4	490	32
HPDS-0983	Overage ± 1	Green	-55 to 100	7.4	1100	32

**Notes:**

Typical values at  $V_{DD} = 5.0V$ ,  $T_A = 25^\circ C$ .

Luminous intensity per LED (Digit Average).

## Glass/Ceramic Package, Serial Interface, 4 character, 5 x 7 Dot Matrix with 128 Character ASCII Decoder

Part Number	Character	COLOR	Interface	Character Height (mm)	Intensity, Typ. (μcd)	Supply, Typ. (mA)
HCMS-2351	4	Yellow	Serial	4.9	3400	6.2
HCMS-2353	4	Green	Serial	4.9	3000	6.2

**Notes:**

Typical values at  $V_{DD} = 5.0V$ ,  $T_A = 25^\circ C$ .

Luminous intensity (peak) per LED (Digit Average).

# LED Indicators and Displays

## LED Dot Matrix Smart Displays Package Dimension Drawings

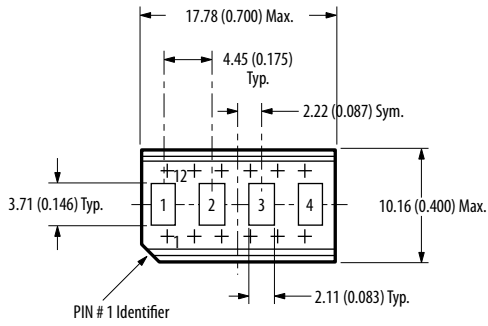

HCMS-290x/HCMS-390x

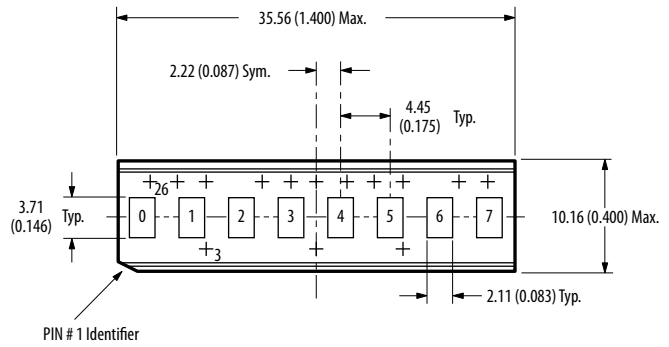

HCMS-291x/HCMS-391x

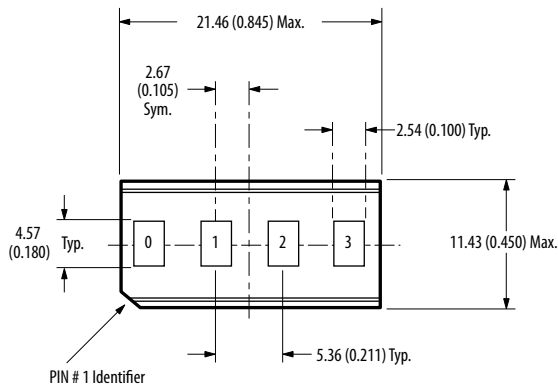

HCMS-296x/HCMS-396x

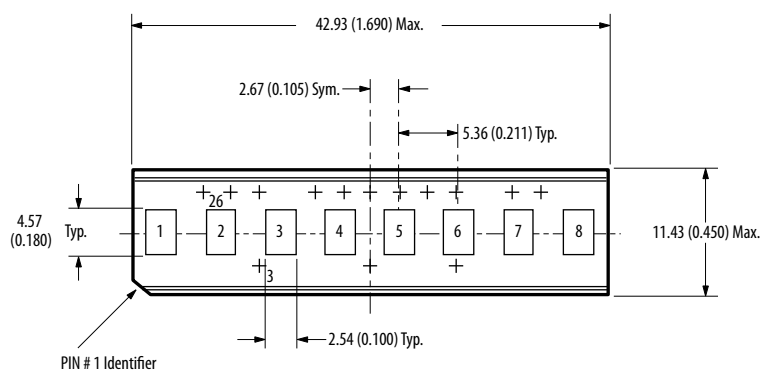

HCMS-297x/HCMS-397x

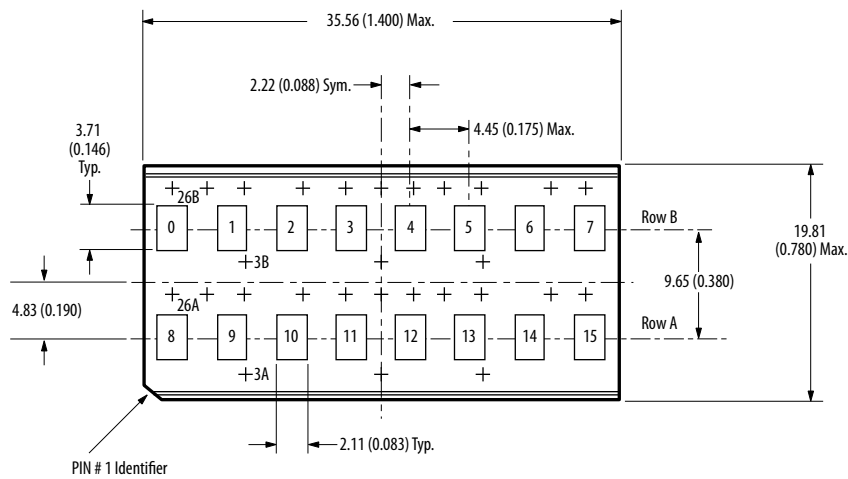

HCMS-292x

**Note:**  
1. Dimensions in millimeters (inches).

# LED Indicators and Displays

## LED Dot Matrix Smart Displays Package Dimension Drawings

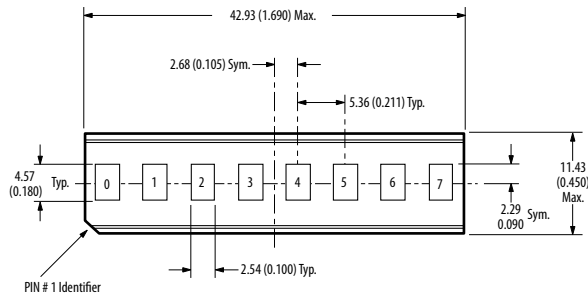

**HDSP-253x**

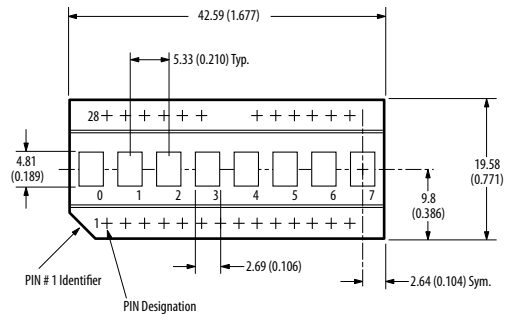

**HDSP-2107, -211x**

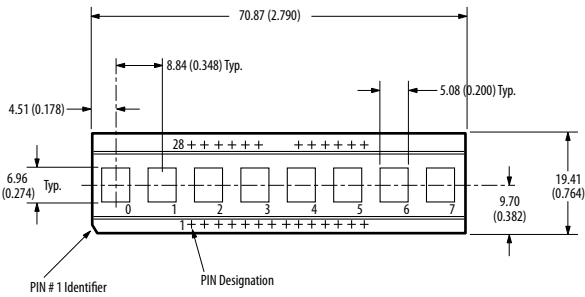

**HDSP-250x**

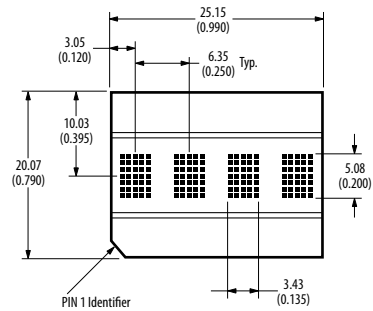

**HDLx-2416**

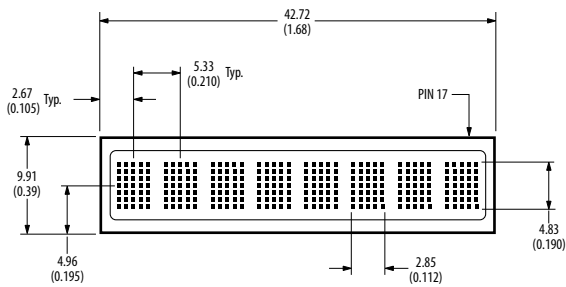

**HDSP-213x, -2179**

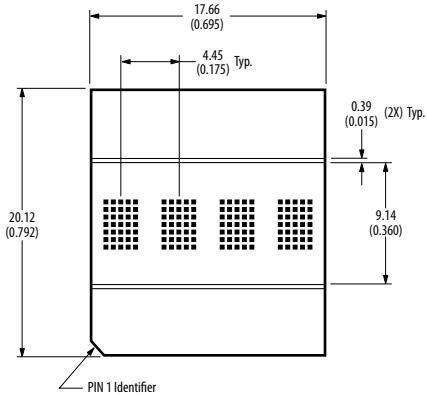

**HDLx-1414**

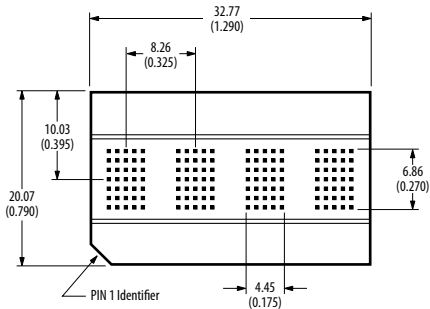

**HDLx-3416**

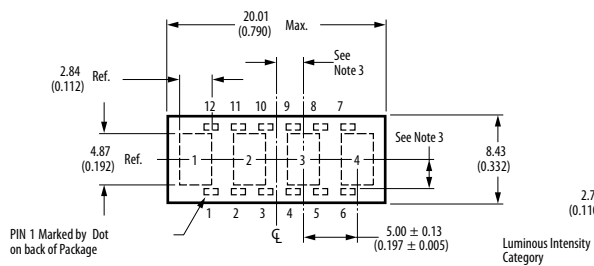

**HDLx-3416**

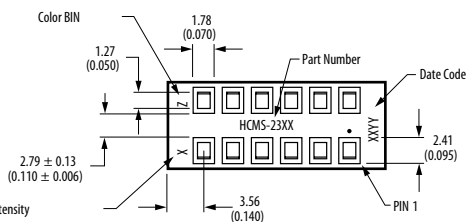

# LED Indicators and Displays

## LED Dot Matrix Smart Displays Package Dimension Drawings

**HDSP-0x81, HDSP-0791**  
**HDSP-0x60, HDSP-0770**

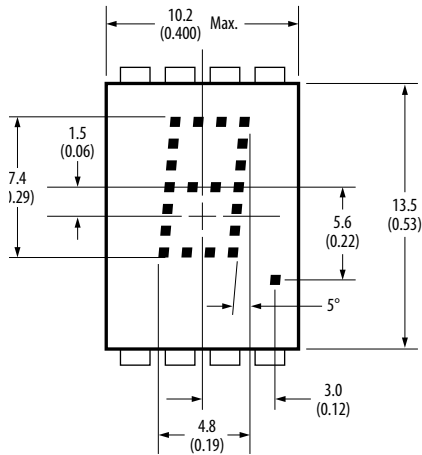

**HDSP-0x82, HDPS-0792**  
**HDSP-0x61, HDPS-0771**

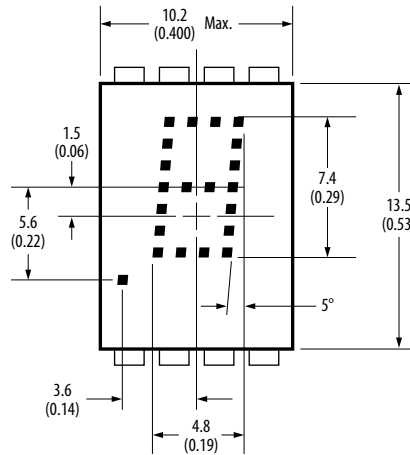

**HDSP-0x84, HDSP-0794**  
**HDSP-0x63**

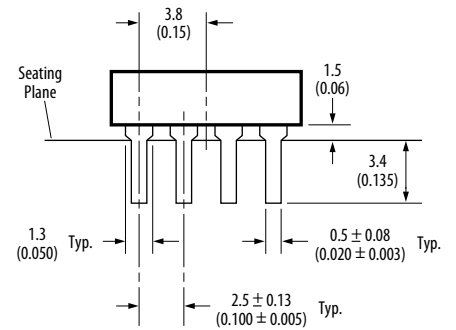
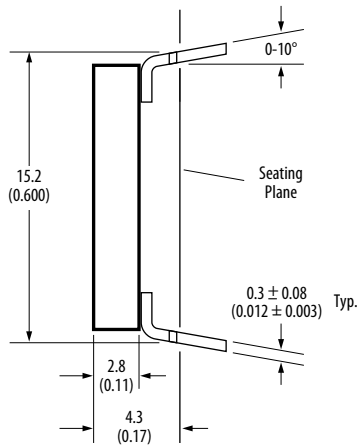
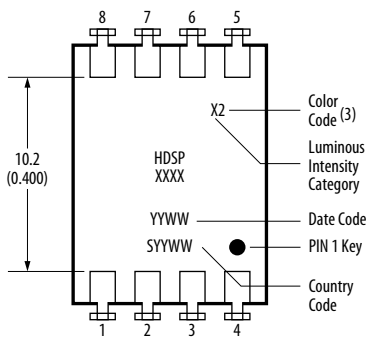
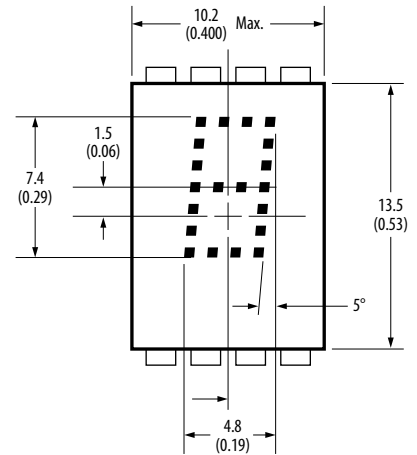

**HDSP-0x83**  
**HDSP-0x62, 0772**

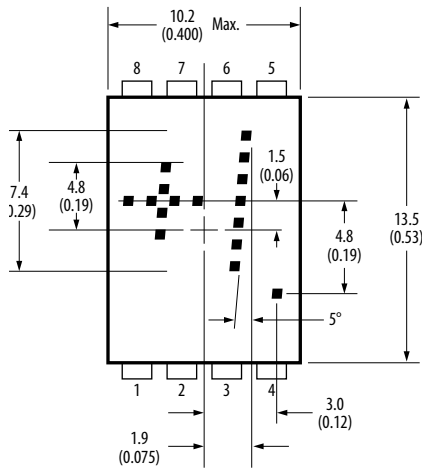

**Notes:**

1. Dimensions in millimeters (inches).
2. Digit center line is  $\pm 0.38\text{MM}$  ( $\pm 0.015$  inch) from package center line.
3. Unless otherwise specified, the tolerance on all dimensions is  $\pm 0.38\text{MM}$  ( $\pm 0.015$  inch).



# Your Imagination. Our Innovation

Avago Technologies is a leading designer, developer and global supplier of a broad range of analog, digital, mixed signal and optoelectronics components and subsystems with a focus in III-V compound and CMOS based semiconductor design and processing. Avago's extensive product portfolio serves four primary target markets: wireless communications, enterprise storage, wired infrastructure, and industrial and other.

Avago has strong market positions across a broad range of market segments with highly differentiated products that include:

- Film Bulk Acoustic Resonator (FBAR) Filters
- RF Front End Modules
- Parallel Optics Transceivers
- High Speed SerDes ASIC
- HDD Read Channel & Preamplifiers
- RAID and SAS I/O Controllers
- PCIe Switches
- Optocouplers
- Motion Encoders
- Industrial Fiber Solutions
- LED Display & Signage Solutions



---

For product information and a complete list of distributors, please visit our website:

[www.avagotech.com](http://www.avagotech.com)

[www.avagotech.com/leds](http://www.avagotech.com/leds)