

## ADM709

### FEATURES

Precision Supply Voltage Monitor  
 +5 V, +3.3 V, +3 V Power Supply Monitor  
 35  $\mu$ A Quiescent Current  
 140 ms (min) Power-On Reset Pulse  
 Low Cost  
 8-Pin DIP/SO Packages  
 Upgrade for MAX709

### APPLICATIONS

Microprocessor Systems  
 Computers  
 Controllers  
 Intelligent Instruments  
 Critical  $\mu$ P Monitoring  
 Automotive Systems  
 Critical  $\mu$ P Power Monitoring

### GENERAL DESCRIPTION

The ADM709 contains a power supply monitor which generates a system reset during power-up, power-down and brownout conditions. When  $V_{CC}$  falls below the reset threshold,  $\overline{\text{RESET}}$  goes low and holds the  $\mu$ P in reset. On power-up the  $\overline{\text{RESET}}$  output is held low for 140 ms after  $V_{CC}$  rises above the threshold. The RESET output remains operational with  $V_{CC}$  as low as 1 V.

Three supply-voltage threshold levels are available suitable for +5 V, +3.3 V and for +3 V supply monitoring. The actual reset voltage threshold is given below.

The ADM709 is available in 8-pin DIP and SOIC packages.

Table I. Reset Threshold

Suffix	Voltage (V)
L	4.65
M	4.40
T	3.08
S	2.93
R	2.63

### FUNCTIONAL BLOCK DIAGRAM

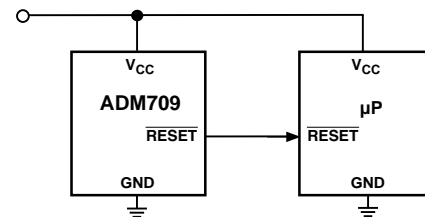

Typical Operating Circuit

### ORDERING GUIDE

Model	Reset Threshold	Temperature Range	Package Option*
ADM709LAN	4.65 V	-40°C to +85°C	N-8
ADM709LAR	4.65 V	-40°C to +85°C	SO-8
ADM709MAN	4.40 V	-40°C to +85°C	N-8
ADM709MAR	4.40 V	-40°C to +85°C	SO-8
ADM709TAN	3.08 V	-40°C to +85°C	N-8
ADM709TAR	3.08 V	-40°C to +85°C	SO-8
ADM709SAN	2.93 V	-40°C to +85°C	N-8
ADM709SAR	2.93 V	-40°C to +85°C	SO-8
ADM709RAN	2.63 V	-40°C to +85°C	N-8
ADM709RAR	2.63 V	-40°C to +85°C	SO-8

\*N = Plastic DIP; SO = SOIC.

REV. 0

Information furnished by Analog Devices is believed to be accurate and reliable. However, no responsibility is assumed by Analog Devices for its use, nor for any infringements of patents or other rights of third parties which may result from its use. No license is granted by implication or otherwise under any patent or patent rights of Analog Devices.

© Analog Devices, Inc., 1995

One Technology Way, P.O. Box 9106, Norwood, MA 02062-9106, U.S.A.  
 Tel: 617/329-4700 Fax: 617/326-8703

# ADM709\* PRODUCT PAGE QUICK LINKS

Last Content Update: 02/23/2017

---

## COMPARABLE PARTS

View a parametric search of comparable parts.

## DOCUMENTATION

### Data Sheet

- ADM709: Power Supply Monitor with Reset Data Sheet

## REFERENCE MATERIALS

### Product Selection Guide

- Supervisory Devices Complementary Parts Guide for Altera FPGAs
- Supervisory Devices Complementary Parts Guide for Xilinx FPGAs

### Solutions Bulletins & Brochures

- Voltage Monitoring Products Applications Guide

## DESIGN RESOURCES

- ADM709 Material Declaration
- PCN-PDN Information
- Quality And Reliability
- Symbols and Footprints

## DISCUSSIONS

View all ADM709 EngineerZone Discussions.

## SAMPLE AND BUY

Visit the product page to see pricing options.

## TECHNICAL SUPPORT

Submit a technical question or find your regional support number.

## DOCUMENT FEEDBACK

Submit feedback for this data sheet.

---

# ADM709—SPECIFICATIONS ( $V_{CC}$ = Full Operating Range, $T_A = T_{MIN}$ to $T_{MAX}$ unless otherwise noted)

Parameter	Min	Typ	Max	Units	Test Conditions/Comments
$V_{CC}$ Operating Voltage Range	1.0		5.5	V	$T_A = 0^\circ\text{C}$ to $+70^\circ\text{C}$
Supply Current	1.2	35	85	$\mu\text{A}$	$T_A = -40^\circ\text{C}$ to $+85^\circ\text{C}$ $V_{CC} < 3.6\text{ V}$ , $T_A = 0^\circ\text{C}$ to $+70^\circ\text{C}$
		35	110	$\mu\text{A}$	$V_{CC} < 3.6\text{ V}$ , $T_A = -40^\circ\text{C}$ to $+85^\circ\text{C}$
		65	150	$\mu\text{A}$	$V_{CC} < 5.5\text{ V}$ , $T_A = 0^\circ\text{C}$ to $+70^\circ\text{C}$
		65	200	$\mu\text{A}$	$V_{CC} < 5.5\text{ V}$ , $T_A = -40^\circ\text{C}$ to $+85^\circ\text{C}$
Reset Threshold	4.5	4.65	4.75	V	ADM709L
	4.25	4.40	4.50	V	ADM709M
	3.00	3.08	3.15	V	ADM709T
	2.85	2.93	3.00	V	ADM709S
	2.55	2.63	2.70	V	ADM709R
$V_{CC}$ to $\overline{\text{RESET}}$ Delay		20		$\mu\text{s}$	$V_{CC}$ = Reset Threshold max–min
$\overline{\text{RESET}}$ Active Time-Out Period	140	280	380	ms	$V_{CC}$ = Reset Threshold max, $V_{CC}$ Rising
$\overline{\text{RESET}}$ Output Voltage			0.3	V	ADM709R/S/T, $I_{\text{SINK}} = 1.2\text{ mA}$ . $V_{CC}$ = Reset Threshold min
			0.4	V	ADM709L/M, $I_{\text{SINK}} = 3.2\text{ mA}$ . $V_{CC}$ = Reset Threshold min
			0.3	V	$I_{\text{SINK}} = 50\ \mu\text{A}$ . $V_{CC} \geq 1.0\text{ V}$
			0.4	V	$I_{\text{SINK}} = 100\ \mu\text{A}$ . $V_{CC} \geq 1.2\text{ V}$
	$0.8 \times V_{CC}$			V	ADM709R/S/T, $I_{\text{SOURCE}} = 500\ \mu\text{A}$ , $V_{CC} \geq$ Reset Threshold max
	$V_{CC}-1.5\text{ V}$			V	ADM709L/M, $I_{\text{SOURCE}} = 800\ \mu\text{A}$ , $V_{CC} \geq$ Reset Threshold max

Specifications subject to change without notice.

## ABSOLUTE MAXIMUM RATINGS\*

( $T_A = +25^\circ\text{C}$  unless otherwise noted)

$V_{CC}$	–0.3 V to +6 V
$\overline{\text{RESET}}$ Output	–0.3 V to $V_{CC} + 0.3\text{ V}$
$V_{CC}$ Input Current	20 mA
$\overline{\text{RESET}}$ Output Current	20 mA
Power Dissipation, N-8 DIP	727 mW
$\theta_{JA}$ Thermal Impedance	135°C/W
Power Dissipation, SO-8 SOIC	470 mW
$\theta_{JA}$ Thermal Impedance	110°C/W
Operating Temperature Range	
Industrial (A Version)	–40°C to +85°C
Lead Temperature (Soldering, 10 secs)	+300°C
Vapor Phase (60 secs)	+215°C
Infrared (15 secs)	+220°C
Storage Temperature Range	–65°C to +150°C
ESD Rating	>5 kV

\*Stresses above those listed under “Absolute Maximum Ratings” may cause permanent damage to the device. This is a stress rating only and functional operation of the device at these or any other conditions above those listed in the operational sections of this specification is not implied. Exposure to absolute maximum ratings for extended periods of time may affect device reliability.

## PIN FUNCTION DESCRIPTION

Mnemonic	Pin No.	Function
NC	1, 4, 5, 6, 8	No Connect Pins.
$V_{CC}$	2	+5 V, +3.3 V, +3 V Power Supply Input.
$\overline{\text{RESET}}$	7	Logic Output. It remains low while $V_{CC}$ is below the reset threshold voltage and for 280 ms (typ) after $V_{CC}$ rises above the threshold.
GND	3	Ground, 0 V.

## PIN CONFIGURATION

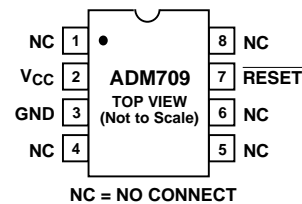

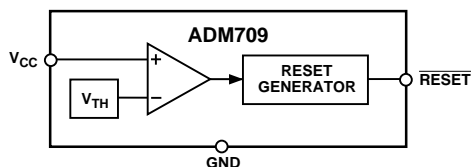

Figure 1. Functional Block Diagram

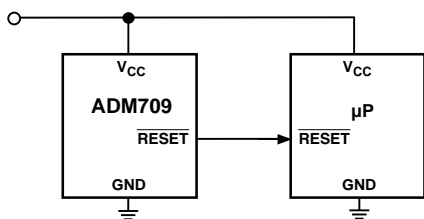

Figure 2. Typical Operating Circuit

## CIRCUIT INFORMATION

### RESET Output

$\overline{\text{RESET}}$  is an active low output which provides a reset signal to the microprocessor whenever the  $V_{CC}$  supply voltage is below the reset threshold. An internal timer holds  $\overline{\text{RESET}}$  low for 140 ms after the voltage on  $V_{CC}$  rises above the threshold. This is intended as a power-on reset signal for the processor. It allows time for the power supply and microprocessor to stabilize after power up. Similarly a power supply brownout will initiate a processor reset. On power-down, the  $\overline{\text{RESET}}$  output remains low with  $V_{CC}$  as low as 1 V. This ensures that the microprocessor is held in a stable shutdown condition as the power supply drops.

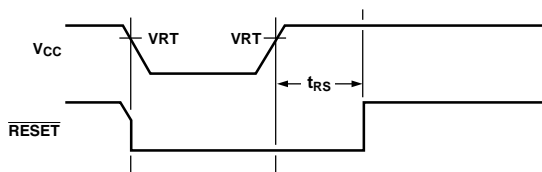

Figure 3. Power Off/On  $\overline{\text{RESET}}$  Timing

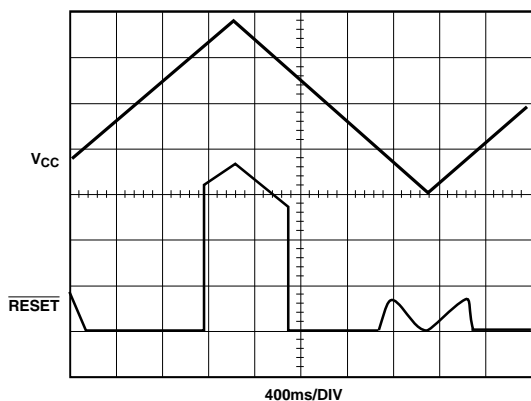

Figure 4.  $\overline{\text{RESET}}$  Output vs.  $V_{CC}$

### RESET at Voltages < 1 V

The ADM709  $\overline{\text{RESET}}$  output is guaranteed to operate with supply voltages as low as 1 V. If it is desired that the  $\overline{\text{RESET}}$  output remains low below 1 V, then a pull-down resistor should be connected between the  $\overline{\text{RESET}}$  output and GND. A resistor of 100 k $\Omega$  is suitable. This is illustrated in Figure 5.

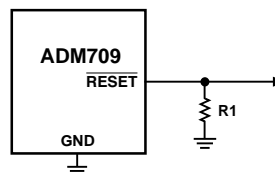

Figure 5.  $\overline{\text{RESET}}$  Valid @  $V_{CC} < 1 \text{ V}$

### Glitch Immunity

The ADM709 is immune to short transients which may occur on the  $V_{CC}$  line. This is important so that spurious resets are not generated as a result of minor glitches on the power supply.

Additional glitch immunity may be obtained by connecting a capacitor (0.1  $\mu\text{F}$  or greater) as close as possible to the  $V_{CC}$  pin on the device.

### Microprocessors with Bidirectional I-O

Some microprocessors or microcontrollers such as the MC68HC11 have bidirectional reset lines. In order to avoid signal contention, a resistor of 4.7 k $\Omega$  should be connected between the ADM709  $\overline{\text{RESET}}$  output and the microcontroller  $\overline{\text{RESET}}$  line. This arrangement is shown in Figure 6.

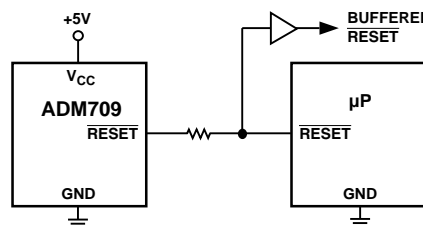
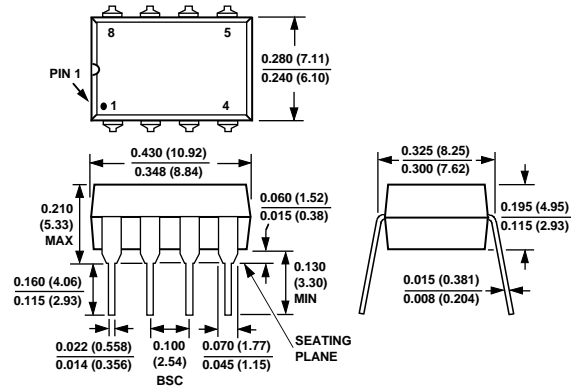

Figure 6. Interfacing to Microprocessors with Bidirectional  $\overline{\text{RESET}}$

## OUTLINE DIMENSIONS

Dimensions shown in inches and (mm).

### 8-Lead Plastic DIP (N-8)



### 8-Lead SOIC (SO-8)

