

Features

Regulated Converters

- Wide 4:1 Input Voltage Range
- 1.6kVDC Isolation
- UL Certified
- Efficiency up to 88%
- Fixed Operating Frequency
- Six-Sided Continuous Shield

RP15-AW

15 Watt Single & Dual Output



Description

The RP15-AW series are ultraminiature wide input voltage range power DC/DC converters in a case half the size of industry standard 15W converters. Despite their small size, the RP15-AW converters are fully specified devices with output currents up to 4 Amps, no minimum load, 1600VDC isolation and low ripple/noise figures. The outputs are also fully protected against short circuits, overcurrent and overvoltage. The RP15-AW series will find many uses in applications where board space and/or board height is at a premium.

Selection Guide

Part Number	Input Voltage Range [VDC]	Output Voltage [VDC]	Output Current [mA]	Input ⁽¹⁾ Current [mA]	Efficiency ⁽¹⁾ typ. [%]	Max. Capacitive Load ⁽²⁾ [μF]
RP15-243.3SAW ^(3,4)	9-36	3.3	4000	640	86	12000
RP15-2405SAW ^(3,4)	9-36	5	3000	727	86	6000
RP15-2412SAW ^(3,4)	9-36	12	1300	747	87	1000
RP15-2415SAW ^(3,4)	9-36	15	1000	718	87	660
RP15-483.3SAW ^(3,4)	18-75	3.3	4000	320	86	12000
RP15-4805SAW ^(3,4)	18-75	5	3000	359	87	6000
RP15-4812SAW ^(3,4)	18-75	12	1300	374	87	1000
RP15-4815SAW ^(3,4)	18-75	15	1000	359	87	660
RP15-2405DAW ^(3,4)	9-36	±5	±1500	735	85	±3000
RP15-2412DAW ^(3,4)	9-36	±12	±625	718	87	±520
RP15-2415DAW ^(3,4)	9-36	±15	±500	710	88	±330
RP15-4805DAW ^(3,4)	18-75	±5	±1500	368	85	±3000
RP15-4812DAW ^(3,4)	18-75	±12	±625	363	86	±520
RP15-4815DAW ^(3,4)	18-75	±15	±500	359	87	±330



UL60950-1 Certified

Notes:

- Note1: Values at nominal input voltage and full load.
 Note2: Test by minimum Vin and constant resistor load.

Model Numbering

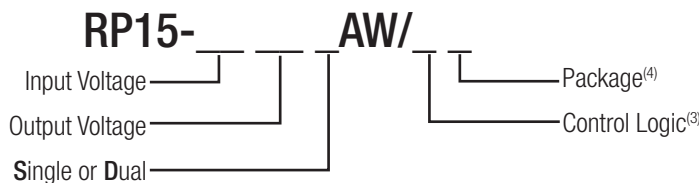

Ordering Examples

- RP15-2405SAW/P = 24V 4:1 Input, 5V Output, Positive Logic CTRL pin and Trim pin fitted.
 RP15-4805DAW-HC = 48V 4:1 Input, ±5V Output, Premounted Heat-sink (no trim pin with dual output)

Notes:

- Note3: Standard part is without suffixes and Trim and CTRL pins are not fitted.
 add suffix "P" for CTRL function with positive logic (1=ON, 0=OFF) and trim pin for single output
 add suffix "N" for CTRL function with negative logic (0=ON, 1=OFF) and trim pin for single output
 Note4: add suffix -HC for premounted Heat-sink and clips

Specifications measured at Ta = 25°C, nominal input voltage, full load otherwise noted

BASIC CHARACTERISTICS

Parameter	Condition	Min.	Typ.	Max.
Input Voltage Range	nom. Vin = 24V nom. Vin = 48V	9VDC 18VDC	24VDC 48VDC	36VDC 75VDC
Under Voltage Lockout (UVLO)	Vin = 24V DC-DC ON DC-DC OFF		8VDC	9VDC
	Vin = 48V DC-DC ON DC-DC OFF		16VDC	18VDC
Input Filter				Pi-Type
Input Reflected Ripple ⁽⁵⁾	nominal Vin and full load		30mA _{p-p}	
Input Surge Voltage	Vin = 24V, 100ms max. Vin = 48V, 100ms max.			50VDC 100VDC
Start-up time	Power up Remote ON/OFF			30ms 30ms
Operating Frequency Range		360kHz	400kHz	440kHz
Minimum Load		0%		
Optional Output Trim ⁽⁶⁾				±10.0%
Ripple and Noise	measured by 20MHz bandwidth with a 1µF M/C X7R and 10µF T/C with a 1µF M/C X7R and 10µF T/C	Single 3.3Vout, 5Vout 12Vout, 15Vout		75mV _{p-p} 100mV _{p-p}
	measured by 20MHz bandwidth with a 1µF M/C X7R and 10µF T/C for each output	Dual		100mV _{p-p}
Remote ON/OFF ⁽⁶⁾	Positive Logic	DC-DC ON DC-DC OFF		Open or 3 < Vr < 15VDC Short or 0 < Vr < 1.2VDC
	Negative Logic	DC-DC ON DC-DC OFF		Short or 0 < Vr < 1.2VDC Open or 3 < Vr < 15VDC
Input current of Remote pin (CTRL)		DC-DC OFF		2.5mA
		DC-DC ON	-0.5mA	1.0mA

Notes:

Note5: Simulated source impedance of 12µH. 12µH inductor in series with +Vin.

Note6: The ON/OFF control function can be positive or negative logic. The pin voltage is referenced to -Vin pin. If no suffix is specified, the control pin will be omitted.

RP15-2405SAW

Efficiency vs. Output Current

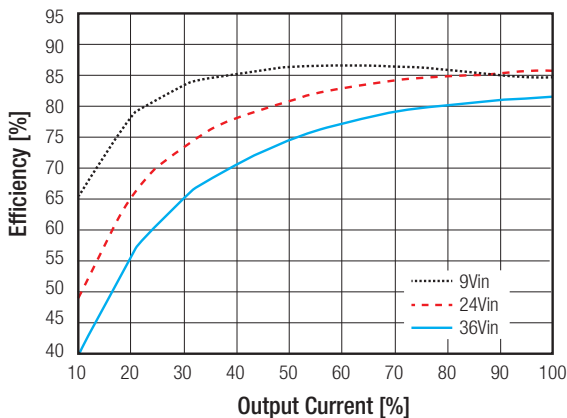

Efficiency vs. Input Voltage

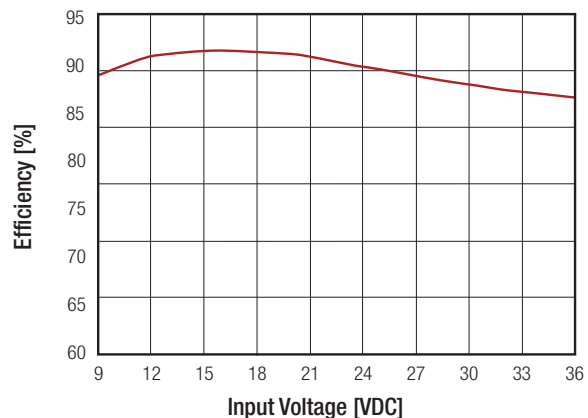

continued on next page

Specifications measured at Ta = 25°C, nominal input voltage, full load otherwise noted

RP15-4805SAW

Efficiency vs. Output Current

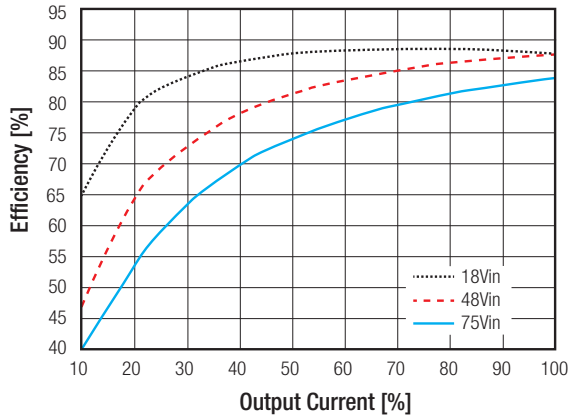

Efficiency vs. Input Voltage

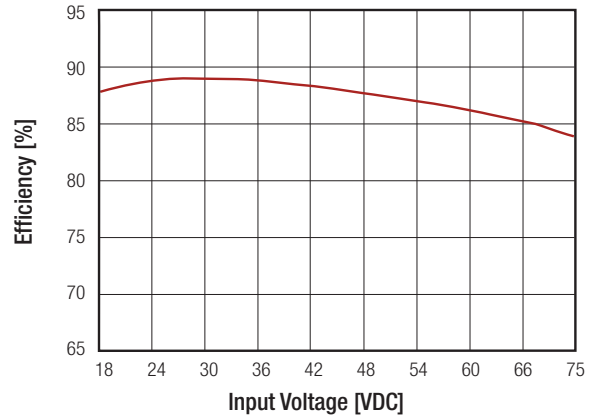

REGULATIONS

Parameter	Condition	Value	
Output Voltage Accuracy	full load and nominal Vin	±1%	
Output Trimming	Single output	±10%	
Line Voltage Regulation	Single	±0.2%	
	Dual	±0.5%	
Load Voltage Regulation	0% to 100% load	Single	±0.2%
		Dual	±1.0%
Cross Regulation	asymmetrical 25% <-> 100% load	±5%	
Transient Response recovery time	25% load step change	250µs typ.	

External Output Trimming

Output Voltage Trimming

Single output Powerline converters offer the feature of trimming the output voltage over a certain range around the nominal value by using external trim resistors. No general equation can be given for calculating the trim resistors, but the following trimtables give typical values for choosing these trimming resistors. If voltages between the given trim points are required, extrapolate between the two nearest given values to work out the resistor required or use a variable resistor to set the output voltage. Output can be externally trimmed by using the method shown below.

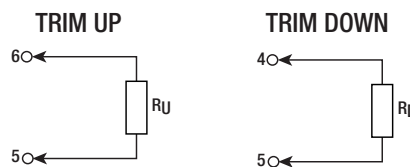

RP15-xx3.3SAW

Trim up	1	2	3	4	5	6	7	8	9	10	%
V _{out} =	3.333	3.366	3.399	3.432	3.465	3.498	3.531	3.564	3.597	3.63	Volts
R _U =	57.93	26.16	15.58	10.28	7.11	4.99	3.48	2.34	1.46	0.75	kOhms
Trim down	1	2	3	4	5	6	7	8	9	10	%
V _{out} =	3.267	3.234	3.201	3.168	3.135	3.102	3.069	3.036	3.003	2.97	Volts
R _D =	69.47	31.23	18.49	12.12	8.29	5.74	3.92	2.56	1.50	0.65	kOhms

continued on next page

Specifications measured at Ta = 25°C, nominal input voltage, full load otherwise noted

RP15-xx05SA											
Trim up	1	2	3	4	5	6	7	8	9	10	%
Vout =	5.05	5.10	5.15	5.20	5.25	5.30	5.35	5.4	5.45	5.50	Volts
R _U =	36.57	16.58	9.92	6.58	4.59	3.25	2.30	1.59	1.03	0.59	kOhms
Trim down	1	2	3	4	5	6	7	8	9	10	%
Vout =	4.95	4.90	4.85	4.80	4.75	4.70	4.65	4.60	4.55	4.50	Volts
R _D =	45.53	20.61	12.31	8.15	5.66	4.00	2.81	1.92	1.23	0.68	kOhms
RP15-xx12SA											
Trim up	1	2	3	4	5	6	7	8	9	10	%
Vout =	12.12	12.24	12.36	12.48	12.60	12.72	12.84	12.96	13.08	13.20	Volts
R _U =	367.91	165.95	98.64	64.98	44.78	31.32	21.70	14.49	8.88	4.39	kOhms
Trim down	1	2	3	4	5	6	7	8	9	10	%
Vout =	11.88	11.76	11.64	11.52	11.40	11.28	11.16	11.04	10.92	10.8	Volts
R _D =	460.99	207.95	123.60	81.42	56.12	39.25	27.20	18.16	11.13	5.51	kOhms
RP15-xx15SA											
Trim up	1	2	3	4	5	6	7	8	9	10	%
Vout =	15.15	15.3	15.45	15.60	15.75	15.90	16.05	16.20	16.35	16.50	Volts
R _U =	404.18	180.59	106.06	68.80	46.44	31.53	20.88	12.90	6.69	1.72	kOhms
Trim down	1	2	3	4	5	6	7	8	9	10	%
Vout =	14.85	14.70	14.55	14.40	14.25	14.10	13.95	13.80	13.65	13.50	Volts
R _D =	499.82	223.41	131.27	85.20	57.56	39.14	25.97	16.10	8.42	2.282	kOhms

PROTECTIONS			
Parameter	Condition	Value	
Short Circuit Protection (SCP)		continuous, automatic recovery	
Over Voltage Protection (OVP)	Zener Diode Clamp	3.3Vout	3.7 - 5.4V
		5Vout	5.6 - 7.0V
		12Vout	13.5 - 19.6V
		15Vout	16.8-20.5V
Over Load Protection (OLP)	% of Iout rated	150% typ.	
Isolation Voltage	I/P to O/P	1.6kVDC/1 minute	
	I/P (O/P) to case	1.0kVDC/1 minute	
Isolation Resistance		1GΩ min.	
Isolation Capacitance		1000pF max.	
Notes: Note7: This power module is not internally fused. An input line fuse must always be used.			

Specifications measured at Ta = 25°C, nominal input voltage, full load otherwise noted

ENVIRONMENTAL		
Parameter	Condition	Value
Operating Temperature Range	without derating	-40°C to +67°C
	with derating	-40°C to +105°C
Maximum Case Temperature		+105°C
Temperature Coefficient		±0.02%/°C max.
Thermal Impedance	Natural convection (20LFM)	18.2°C/Watt
	Natural convection (20LFM) with Heat sink	15.8°C/Watt
Operating Humidity		5% - 95% RH
Thermal Shock		MIL-STD-810F
Vibration		MIL-STD-810F
MTBF	MIL-HDBK-217F	1459 x 10 ³ hours
	Bellcore TR-NWT-000332 ⁽⁹⁾	1330 x 10 ³ hours

Derating Graph⁽⁹⁾

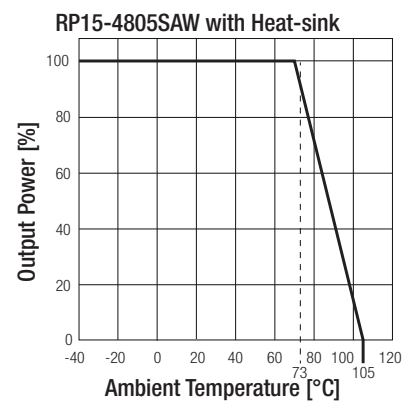
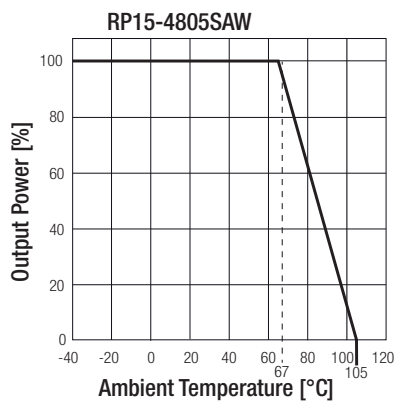

Notes:

Note8: BELLCORE TR-NWT-000332. Case I: 50% Stress, Temperature at 40°C.

MIL-HDBK 217F Notice 2. Ta = 25°C, full load, (Ground, Benign, controlled environment).

Note9: Derating graphs are valid only for the shown part numbers. If you need detailed derating-information about a part-number not shown here please contact our technical support service at techsupportAT@recom-power.com.

SAFETY AND CERTIFICATIONS

Certificate Type (Safety)	Report / File Number	Standard
UL General Safety	E196683	UL60950-1 1st Ed.: 2003 C22.2 No. 60950 1st. Ed.: 2003
EMC Compliance	Condition	Standard / Criterion
EMI Standard ⁽¹⁰⁾	with external filter	EN55022, Class A, Class B
ESD	Air ±8kV and Contact ± 6kV	EN61000-4-2, Criteria A
Radiated Immunity	10 V/m	EN61000-4-3, Criteria A
Fast Transient ⁽¹¹⁾	±2kV	EN61000-4-4, Criteria A
Surge ⁽¹¹⁾	±1kV	EN61000-4-5, Criteria A
Conducted Immunity	3 Vr.m.s	EN61000-4-6, Criteria A

continued on next page

Specifications measured at $T_a = 25^\circ\text{C}$, nominal input voltage, full load otherwise noted

Notes:

Note10: The standard modules meet EMI Class A or Class B with external components, see filter suggestions below.

Note11: An external input filter capacitor is required if the module has to meet EN61000-4-4, EN61000-4-5. The filter capacitor Recom suggests: Nippon chemi-con KY series, 220 μF /100V.

EMI Filtering Class A

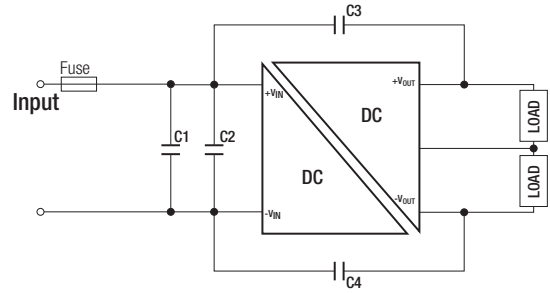
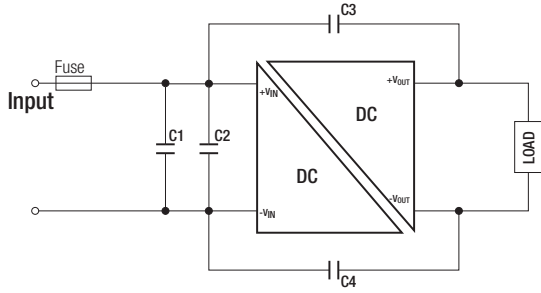

MODEL	C1	C2	C3/C4
RP15-24xxS_DAW	6.8 μF /50V 1812 MLCC	6.8 μF /50V 1812 MLCC	470pF/2kV 1808 MLCC
RP15-48xxS_DAW	2.2 μF /100V 1812 MLCC	2.2 μF /100V 1812 MLCC	470pF/2kV 1808 MLCC

EMI Filtering Class B

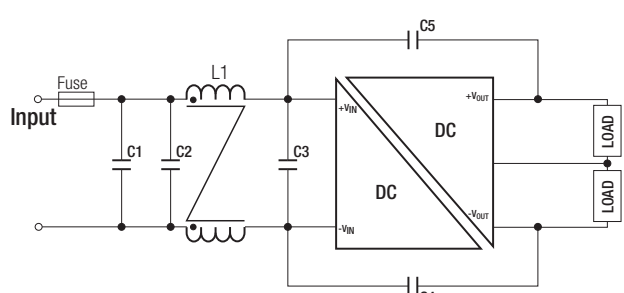
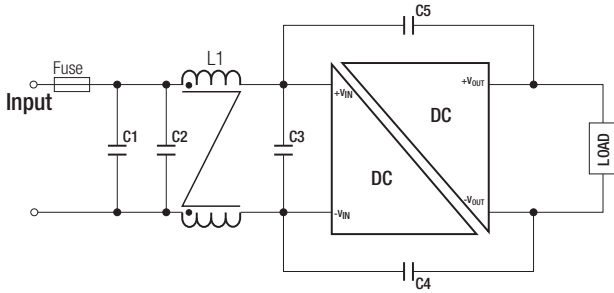

MODEL	C1	C2	C3	C4/C5	L1
RP15-24xxS_DAW	6.8 μF /50V 1812 MLCC	N/A	6.8 μF /50V 1812 MLCC	470pF/2kV 1808 MLCC	CMC: 325 μH ref: WE 744290321 ref.: CMC-06
RP15-48xxS_DAW	2.2 μF /100V 1812 MLCC	2.2 μF /100V 1812 MLCC	2.2 μF /100V 1812 MLCC	1000pF/2kV 1808 MLCC	325 μH ref: WE 744290321 ref.: CMC-06

DIMENSIONS and PHYSICAL CHARACTERISTICS

Parameter	Type	Value
Material	Case	Nickel coated copper
	Base	FR4 PCB
	Potting	Epoxy (UL94-V0)
Package Dimensions (LxWxH)	without Heat-sink	25.4 x 25.4 x 9.9mm
	with Heat-sink	31.4 x 25.4 x 16.5mm
Package Weight	without Heat-sink	15g
	with Heat-sink	21.44g

continued on next page

Specifications measured at Ta = 25°C, nominal input voltage, full load otherwise noted

Dimension Drawing (mm)

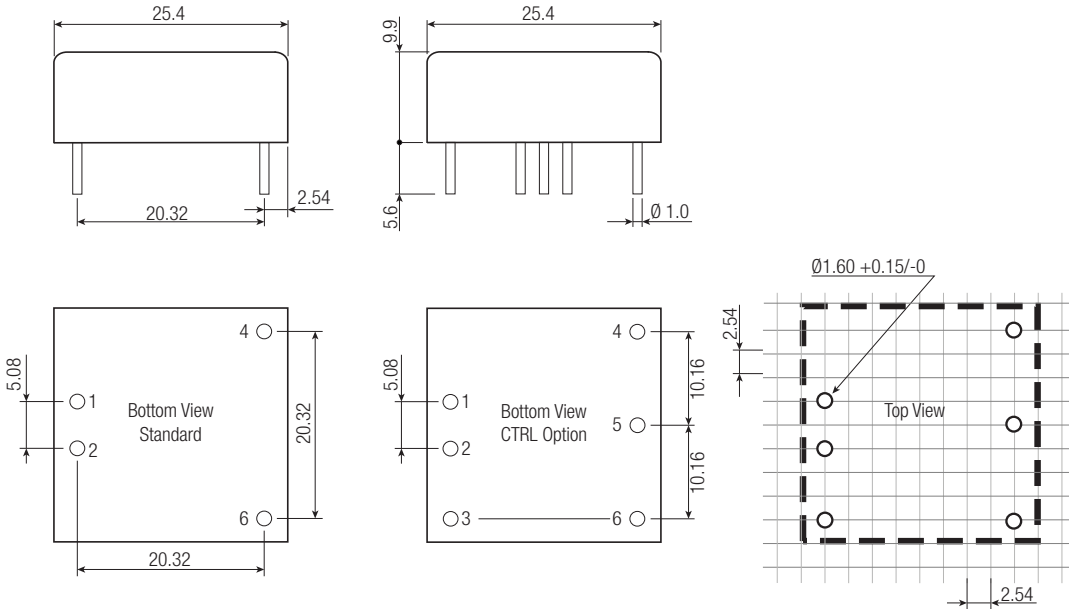
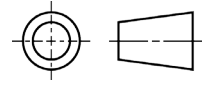

Dimension Drawing (mm) with Heat-sink

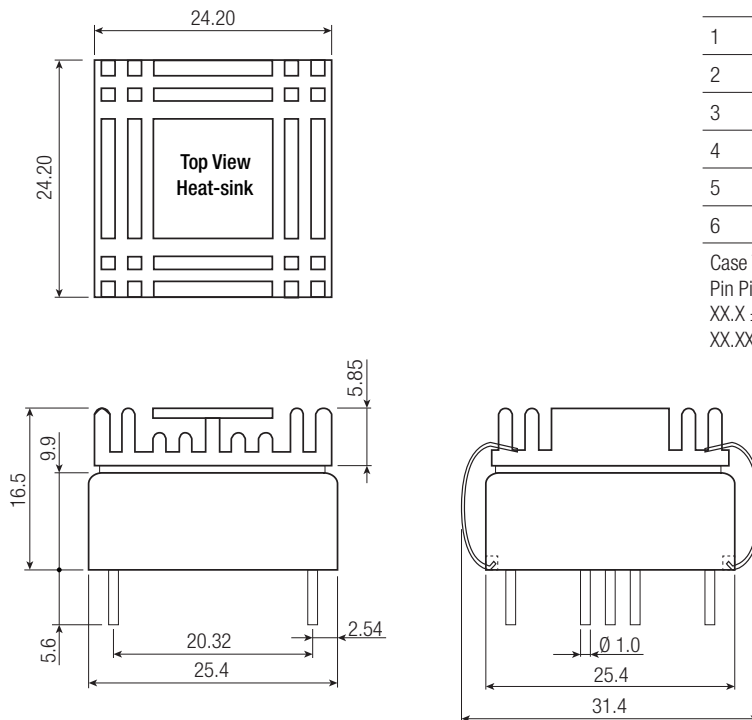

Pin Connections

Pin #	Single	Single /P or /N	Dual	Dual /P or /N
1	+Vin	+Vin	+Vin	+Vin
2	-Vin	-Vin	-Vin	-Vin
3	no Pin	CTRL	no Pin	CTRL
4	+Vout	+Vout	+Vout	+Vout
5	no Pin	Trim	Com	Com
6	-Vout	-Vout	-Vout	-Vout

Case Tolerance $\pm 0.5\text{mm}$
Pin Pitch Tolerance $\pm 0.25\text{mm}$
XX.X $\pm 0.5\text{mm}$
XX.XX $\pm 0.25\text{mm}$

Specifications measured at Ta = 25°C, nominal input voltage, full load otherwise noted

PACKAGING INFORMATION		
Parameter	Type	Value
Packaging Quantity	without Heat-sink	Tube 8pcs.
	with Heat-sink	Tray 20pcs.
Storage Temperature Range		-55°C to +125°C
Storage Humidity		5% - 95% RH