

THIS DRAWING IS UNPUBLISHED.

RELEASED FOR PUBLICATION

© COPYRIGHT - By -

ALL RIGHTS RESERVED.

LOC GP DIST 00

REVISIONS

P	LTR	DESCRIPTION	DATE	DWN	APVD
	P	REVISED PER ECO-11-004835	11MAR11	RK	HMR

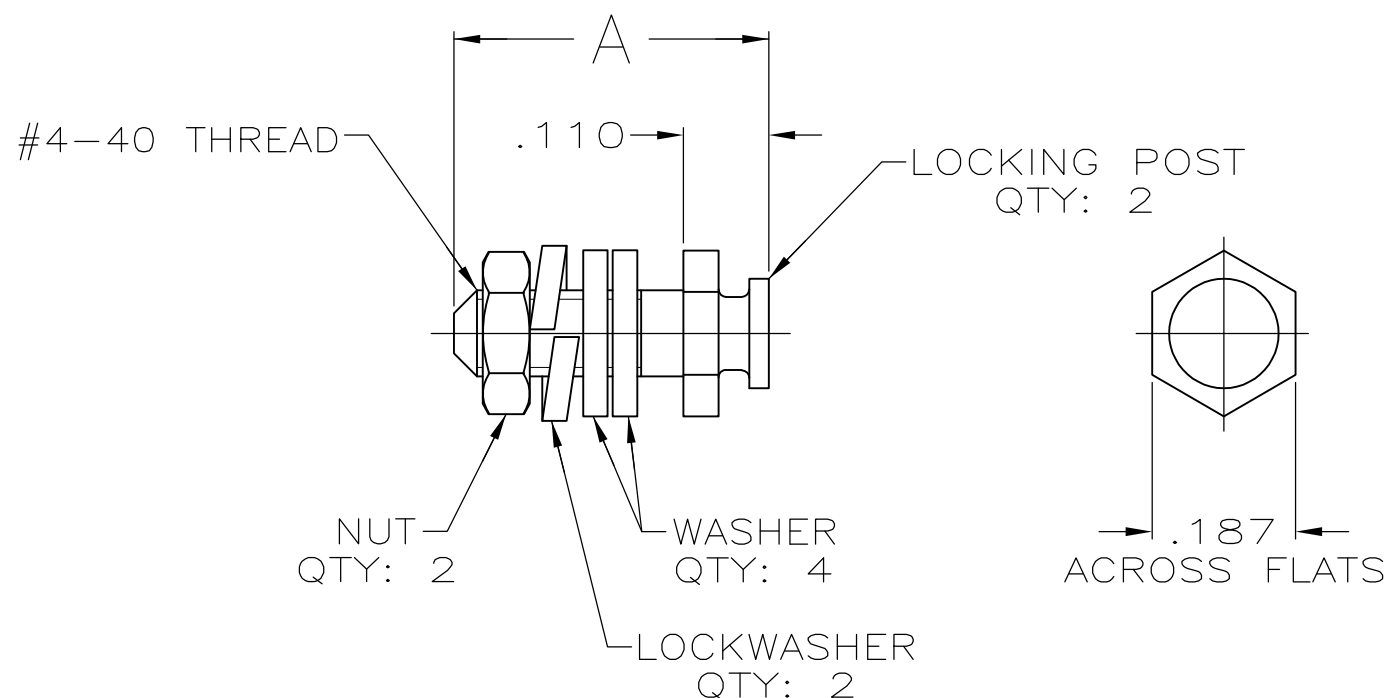

- 1 ZINC PLATED .000200-.000400 THICK, YELLOW CHROMATE.
- 2 ZINC PLATED .000200-.000400 THICK, CLEAR CHROMATE.
- 3 PARTS PACKAGED UNASSEMBLED.
- 4 PARTS PACKAGED AS A UNIT KIT.
- 5 PARTS INDIVIDUALLY BULK PACKAGED & SHIPPED AS A UNIT PACKAGE.

5	1	.560	5206514-7
4	1	.560	5206514-6
4	2	.410	5206514-4
5	1	.410	5206514-3
4	1	.410	5206514-1
PACKAGING	FINISH	A	PART NO

THIS DRAWING IS A CONTROLLED DOCUMENT.		DWN S.WAITMAN 27JUN05	STE TE Connectivity													
DIMENSIONS: INCHES		CHK C.ROHDE 27JUN05														
TOLERANCES UNLESS OTHERWISE SPECIFIED:		APVD M.WALMSLEY 27JUN05	NAME LOCKING POST KIT, AMPLIMITE													
<table border="1"> <tr><td>0 PLC</td><td>± -</td></tr> <tr><td>1 PLC</td><td>± -</td></tr> <tr><td>2 PLC</td><td>± -</td></tr> <tr><td>3 PLC</td><td>± .015</td></tr> <tr><td>4 PLC</td><td>± -</td></tr> <tr><td>ANGLES</td><td>± -</td></tr> </table>		0 PLC	± -	1 PLC	± -	2 PLC	± -	3 PLC	± .015	4 PLC	± -	ANGLES	± -	PRODUCT SPEC -	RESTRICTED TO -	
0 PLC	± -															
1 PLC	± -															
2 PLC	± -															
3 PLC	± .015															
4 PLC	± -															
ANGLES	± -															
MATERIAL COLD ROLLED STEEL		FINISH SEE TABLE	APPLICATION SPEC -	SIZE A3												
		WEIGHT -	CAGE CODE 00779	DRAWING NO C-5206514												
CUSTOMER DRAWING			SCALE 4:1	SHEET 1 OF 1												
			REV P													