

PART No. 2CLDC3643

for more information visit
www.hammfg.com

Data subject to change without notice

Isometric drawing Not to Scale

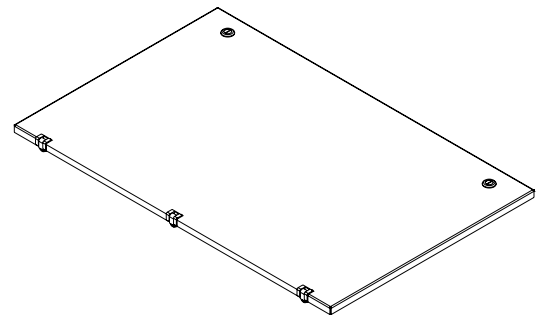

ISOMETRIC VIEW



FRONT VIEW

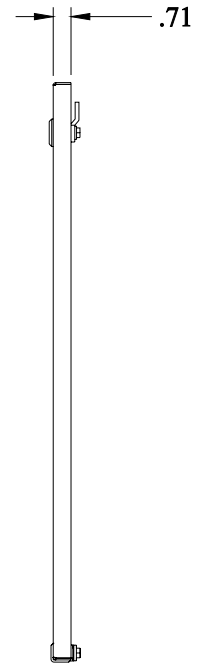

RIGHT SIDE VIEW