

Low $V_{CE(sat)}$

2SA1746

Silicon PNP Epitaxial Planar Transistor

Application : Chopper Regulator, Switch and General Purpose

■ Absolute maximum ratings (Ta=25°C)

Symbol	Ratings	Unit
V_{CB0}	-70	V
V_{CE0}	-50	V
V_{EB0}	-6	V
I_C	-12(Pulse-20)	A
I_B	-4	A
P_C	60(Tc=25°C)	W
T_J	150	°C
T_{stg}	-55 to +150	°C

■ Electrical Characteristics (Ta=25°C)

Symbol	Conditions	Ratings	Unit
I_{CB0}	$V_{CB} = -70V$	-10max	μA
I_{EB0}	$V_{EB} = -6V$	-10max	μA
$V_{(BR)CEO}$	$I_C = -25mA$	-50min	V
h_{FE}	$V_{CE} = -1V, I_C = -5A$	50min	
$V_{CE(sat)}$	$I_C = -5A, I_B = -80mA$	-0.5max	V
$V_{BE(sat)}$	$I_C = -5A, I_B = -80mA$	-1.2max	V
f_T	$V_{CE} = -12V, I_E = 1A$	25typ	MHz
C_{OB}	$V_{CB} = -10V, f = 1MHz$	400typ	pF

External Dimensions FM100(TO3PF)

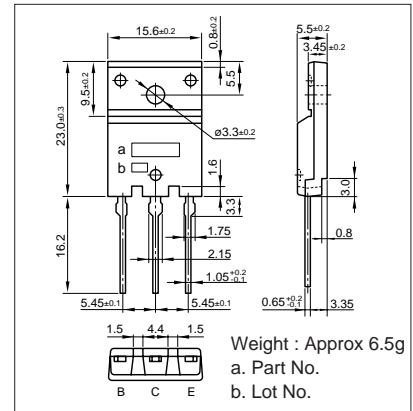

■ Typical Switching Characteristics (Common Emitter)

V_{CC} (V)	R_L (Ω)	I_C (A)	V_{BB1} (V)	V_{BB2} (V)	I_{B1} (mA)	I_{B2} (mA)	t_{on} (μs)	t_{stg} (μs)	t_f (μs)
-20	4	-5	-10	5	-80	80	0.5typ	0.6typ	0.3typ

$I_C - V_{CE}$ Characteristics (Typical)

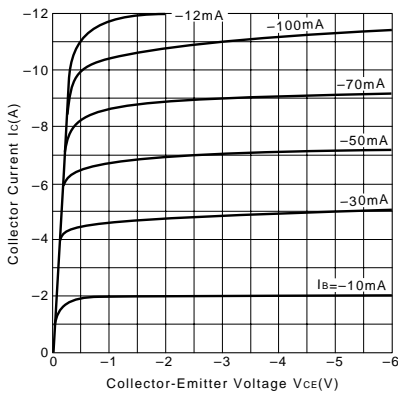

$V_{CE(sat)} - I_B$ Characteristics (Typical)

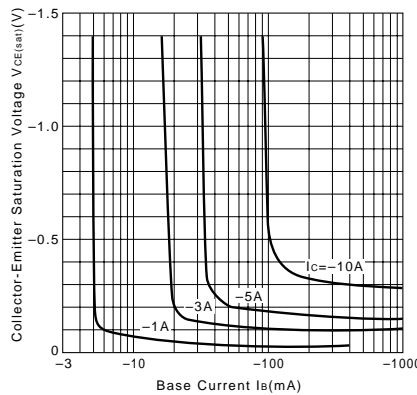

$I_C - V_{BE}$ Temperature Characteristics (Typical)

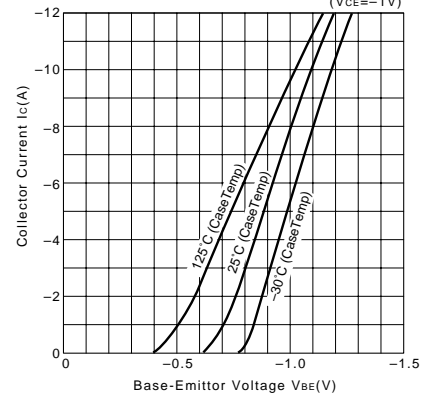

$h_{FE} - I_C$ Characteristics (Typical)

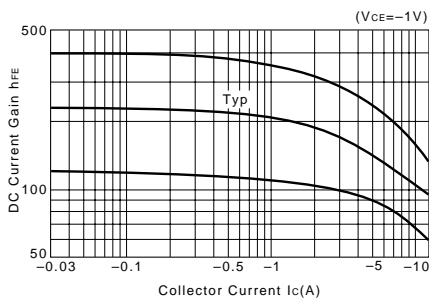

$h_{FE} - I_C$ Temperature Characteristics (Typical)

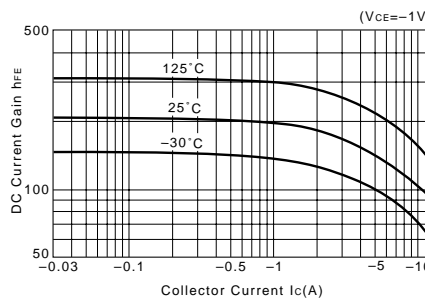

θ_{j-a-t} Characteristics

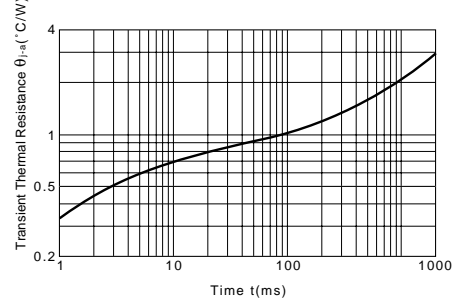

$f_T - I_E$ Characteristics (Typical)

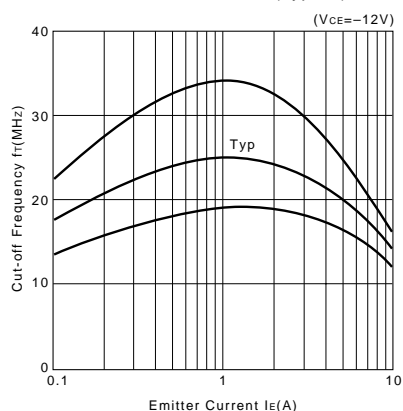

Safe Operating Area (Single Pulse)

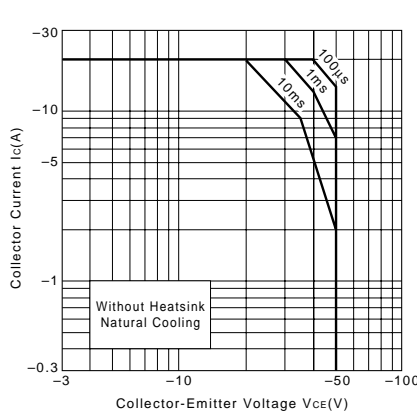

$P_C - T_a$ Derating

