

FSR® 400 Series Data Sheet

Force Sensing Resistors®

Features and Benefits

- Actuation force as low as 0.2N and sensitivity range to 20N
- Cost effective
- Ultra thin
- Robust; up to 10M actuations
- Simple and easy to integrate

Description

Interlink Electronics FSR® 400 Series is part of the single zone Force Sensing Resistor® family. Force Sensing Resistors, or FSR's, are robust polymer thick film (PTF) devices that exhibit a decrease in resistance with increase in force applied to the surface of the sensor. This force sensitivity is optimized for use in human machine interface devices including automotive electronics, medical systems, industrial controls and robotics.

The FSR 400 Series sensors come in seven different models with four different connecting options. A battery operated demo is available. Call us for more information at +1 805-484-8855.



FSR® 400 Short
5mm Circle x 20mm



FSR® 400
5mm Circle x 38mm



FSR® 402 Short
13mm Circle x 25mm



FSR® 402
13mm Circle x 56mm



FSR® 404
20mm Donut with 5.5mm hold

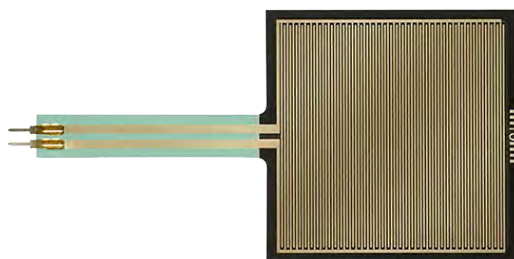

FSR® 406
38mm Square x 83mm

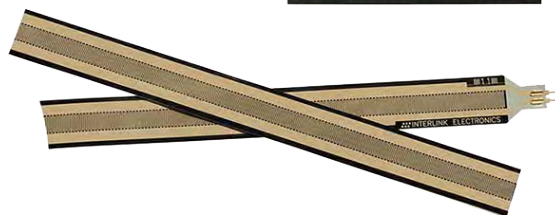

FSR® 408-xxx
10mm Wide x xxx mm strip
xxx = 50, 100, 200, 300, 400, 500mm

Device Characteristics

Actuation Force*	~0.2N min
Force Sensitivity Range*	~0.2N – 20N
Force Resolution	Continuous (analog)
Force Repeatability Single Part	+/- 2%
Force Repeatability Part to Part	+/- 6% (Single Batch)
Non-Actuated Resistance	>10 Mohms
Hysteresis	+10% Average (RF+ - RF-)/RF+
Device Rise Time	< 3 Microseconds
Long Term Drift 1kg load, 35 days	< 5% log ₁₀ (time)
Operating Temperature Performance Cold: -40°C after 1 hour Hot: +85°C after 1 hour Hot Humid: +85°C 95RH after 1 hour	-5% average resistance change -15% average resistance change +10% average resistance change
Storage Temperature Performance Cold: -25°C after 120 hours Hot: +85°C after 120 hours Hot Humid: +85°C 95RH after 240 hours	-10% average resistance change -5% average resistance change +30% average resistance change
Tap Durability Tested to 10 Million actuations, 1kg, 4Hz	-10% average resistance change
Standing Load Durability 2.5kg for 24 hours	-5% average resistance change
EMI	Generates no EMI
ESD	Not ESD Sensitive
UL	All materials UL grade 94 V-1 or better
RoHS	Compliant

FSR® 400 Series Data Sheet

Force Sensing Resistor®

Connector Information

Bare Tail

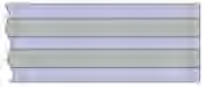

Female Tin Contacts
PN: TE 2-487406-4



Female Tin Contacts with 2 Pin Housing
PN: TE 2-487406-4
PN: TE 487378-1



Solder Tabs
PN: TE 1-88997-2



Other Available Part Numbers:
Hardware Development Kit, PN 54-76247

Application Information

For specific application needs please contact Interlink Electronics support team. An Integration Guide and Hardware Development Kit (HDK) are also available. FSR's are two-wire devices with a resistance that depends on applied force. Below is a force vs. resistance graph that illustrates a typical FSR® response characteristic. Please note that the graph values are reference only and actual values are dependent upon actuation system mechanics and sensor geometry.

For simple force-to-voltage conversion, the FSR device is tied to a measuring resistor in a voltage divider (see figure below) and the output is described by the following equation.

$$V_{OUT} = \frac{R_M V_+}{(R_M + R_{FSR})}$$

In the configuration shown, the output voltage increases with increasing force. If R_{FSR} and R_M are swapped, the output swing will decrease with increasing force. The measuring resistor, R_M , is chosen to maximize the desired force sensitivity range and to limit current. Depending on the impedance requirements of the measuring circuit, the voltage divider could be followed by an op-amp.

A family of force vs. V_{OUT} curves is shown on the graph below for a standard FSR in a voltage divider configuration with various R_M resistors. A V_+ of 5V was used for these examples. Please note that the graph values are for reference only and will vary between different sensors and applications.

Refer to the FSR Integration Guide for more integration methods and techniques.

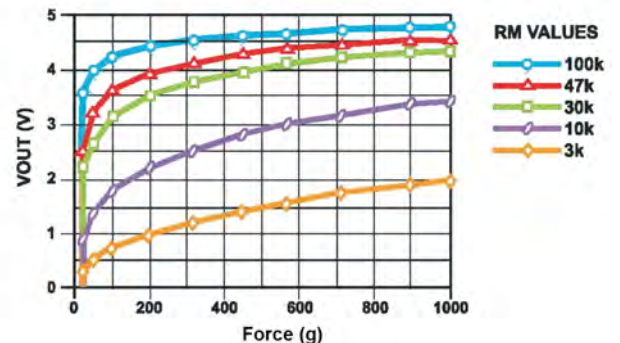
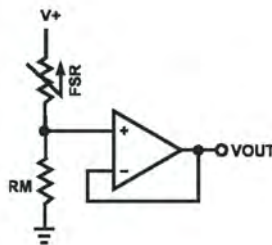
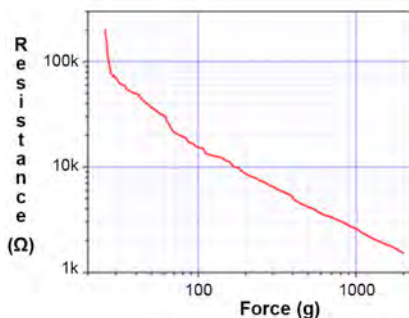

Model 400:

Active Area: $\text{Ø}5.08\text{mm}$
 Nominal Thickness: 0.30mm
 Switch Travel: 0.05mm

Available Part Numbers:

- PN: 34-00007 Model 400
- No contacts or solder tabs
- PN: 34-00011 Model 400
- with female contacts
- PN: 34-44001 Model 400
- with female contacts and housing
- PN: 30-49649 Model 400
- with solder tabs

Sensor Mechanical Data

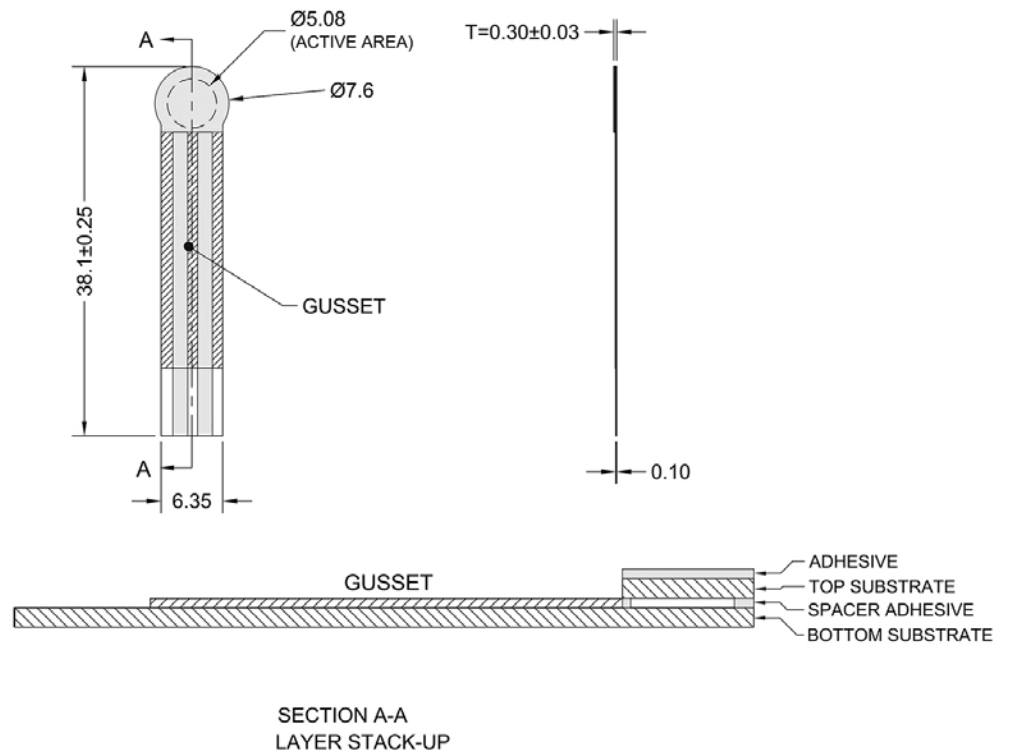

Exploded View

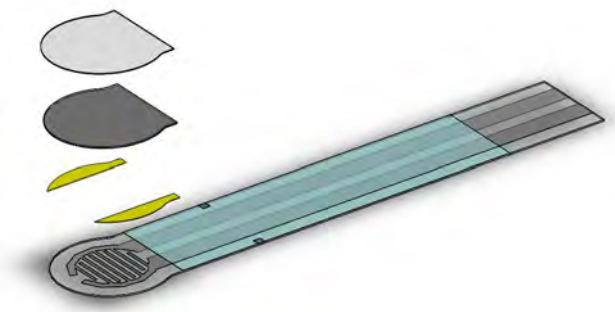

FSR® Model 400 Short Tail

Force Sensing Resistor®

Model 400 Short Tail:

Active Area: $\varnothing 5.62\text{mm}$
Nominal Thickness: 0.30mm
Switch Travel: 0.05mm

Available Part Numbers:

- PN: 34-47021 Model 400 Short Tail
- No contacts or solder tabs
- PN: 34-00005 Model 400 Short Tail
- with female contacts
- PN: 34-00006 Model 400 Short Tail
- with female contacts and housing
- PN: 34-00004 Model 400 Short Tail
- with solder tabs

Sensor Mechanical Data

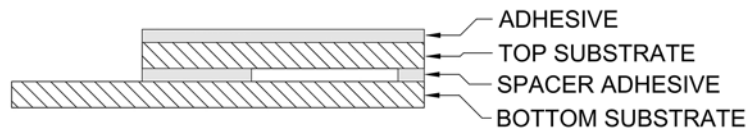
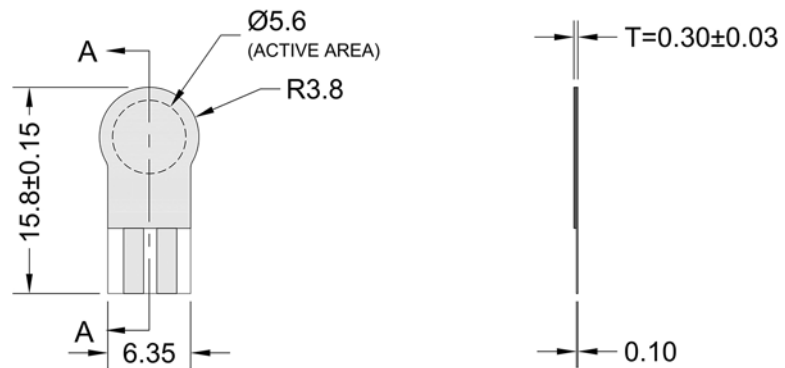

SECTION A-A
LAYER STACK-UP

Exploded View



Model 402:

Active Area: $\varnothing 14.68\text{mm}$
 Nominal Thickness: 0.46mm
 Switch Travel: 0.15mm

Available Part Numbers:

- PN: 44-29103 Model 402
- No contacts or solder tabs
- PN: 34-00012 Model 402
- with female contacts
- PN: 34-00001 Model 402
- with female contacts and housing
- PN: 30-81794 Model 402
- with solder tabs

Sensor Mechanical Data

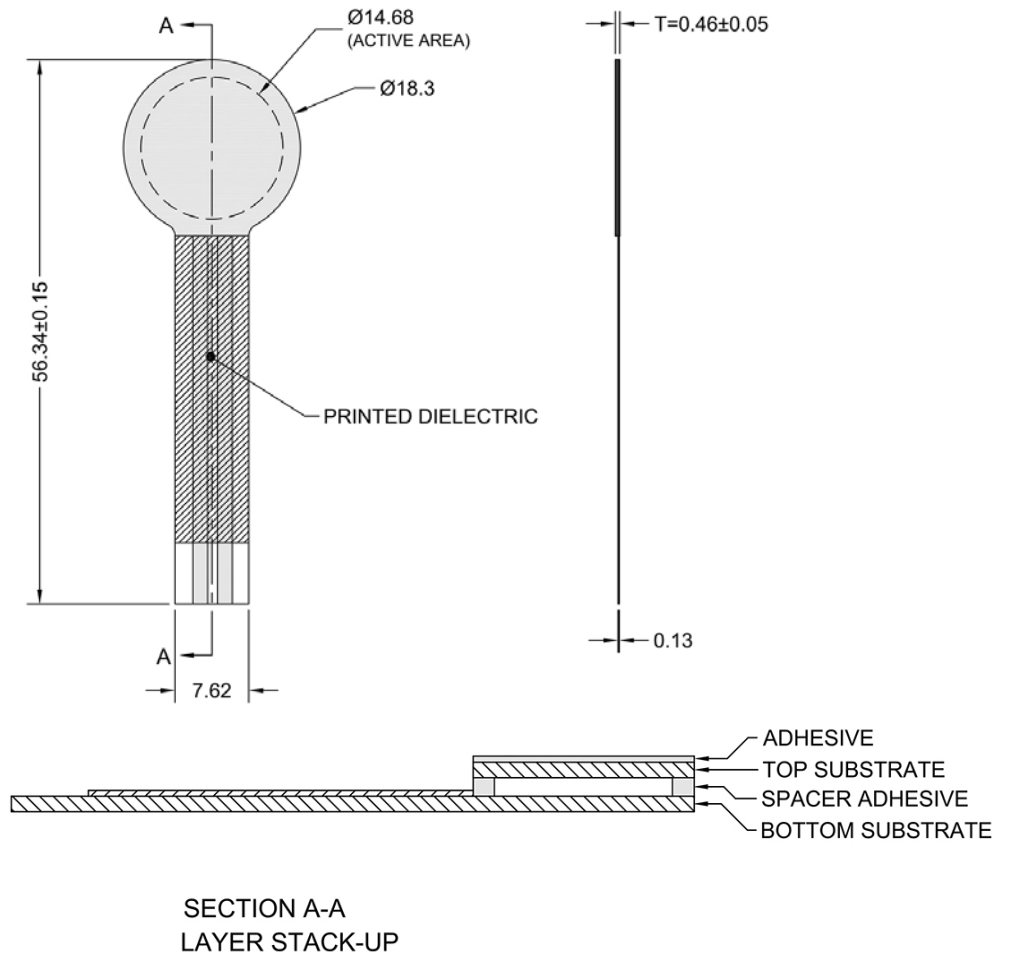

Exploded View

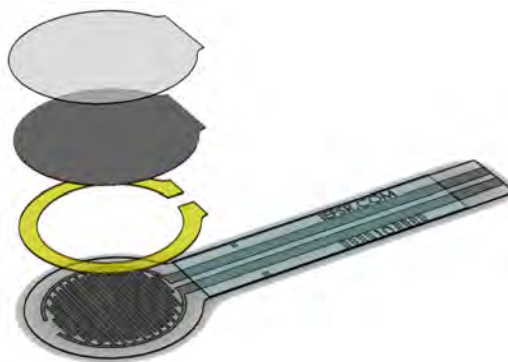

FSR® Model 402 Short Tail

Force Sensing Resistor®

Model 402 Short Tail:

Active Area: $\varnothing 12.70\text{mm}$
Nominal Thickness: 0.46mm
Switch Travel: 0.15mm

Available Part Numbers:

- PN: 34-00016 Model 402 Short Tail
- No contacts or solder tabs
- PN: 34-00017 Model 402 Short Tail
- with female contacts
- PN: 34-00018 Model 402 Short Tail
- with female contacts and housing
- PN: 34-00015 Model 402 Short Tail
- with solder tabs

Sensor Mechanical Data

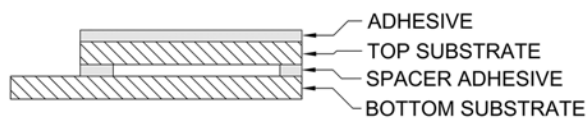
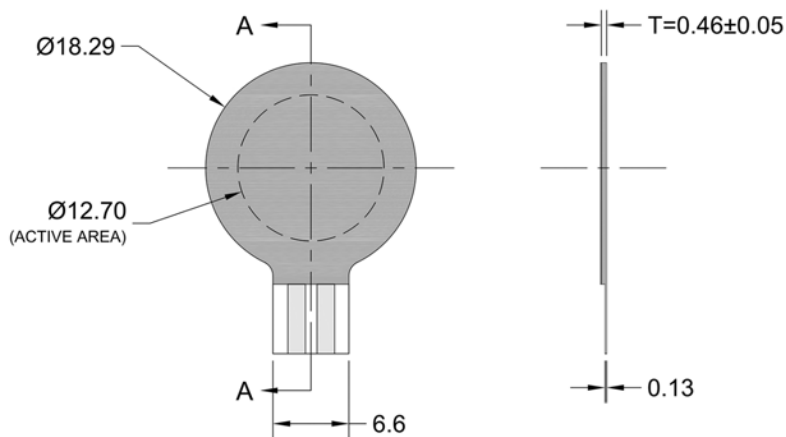

SECTION A-A
LAYER STACK-UP

Exploded View



FSR® Model 404 Single Zone Donut

Force Sensing Resistor®

Model 404 Single Zone Donut:

Active Area: $\text{Ø}4.35\text{mm}$
Nominal Thickness: 0.53mm
Switch Travel: 0.05mm

Available Part Numbers:

PN: 34-00065 Model 404 Single Zone Donut
- with solder tabs

Sensor Mechanical Data

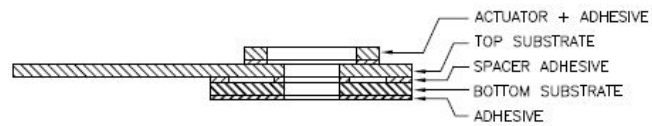
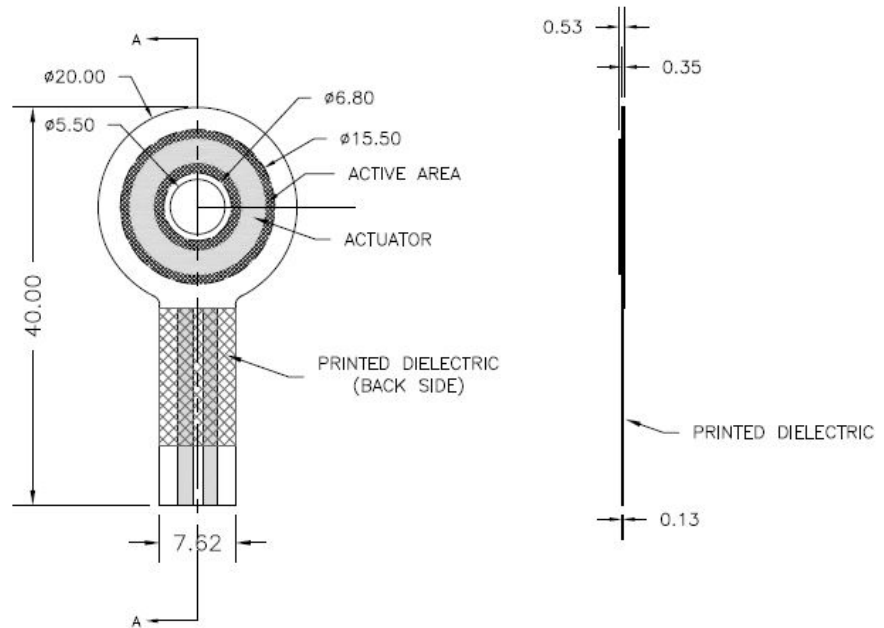

Exploded View

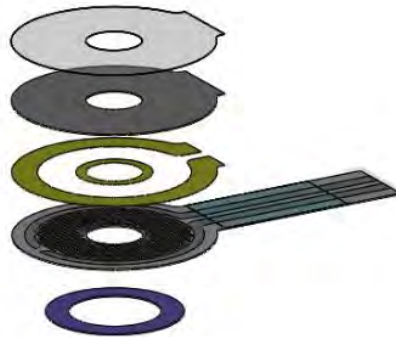

Model 406:

Active Area: 39.6mm x 39.6mm
Nominal Thickness: 0.46mm
Switch Travel: 0.15mm

Available Part Numbers:

- PN: 34-00009 Model 406
- No contacts or solder tabs
- PN: 34-00013 Model 406
- with female contacts
- PN: 34-61152 Model 406
- with female contacts and housing
- PN: 30-73258 Model 406
- with solder tabs

Sensor Mechanical Data

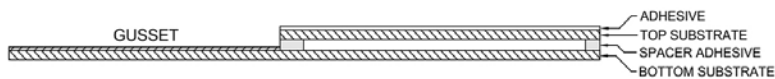
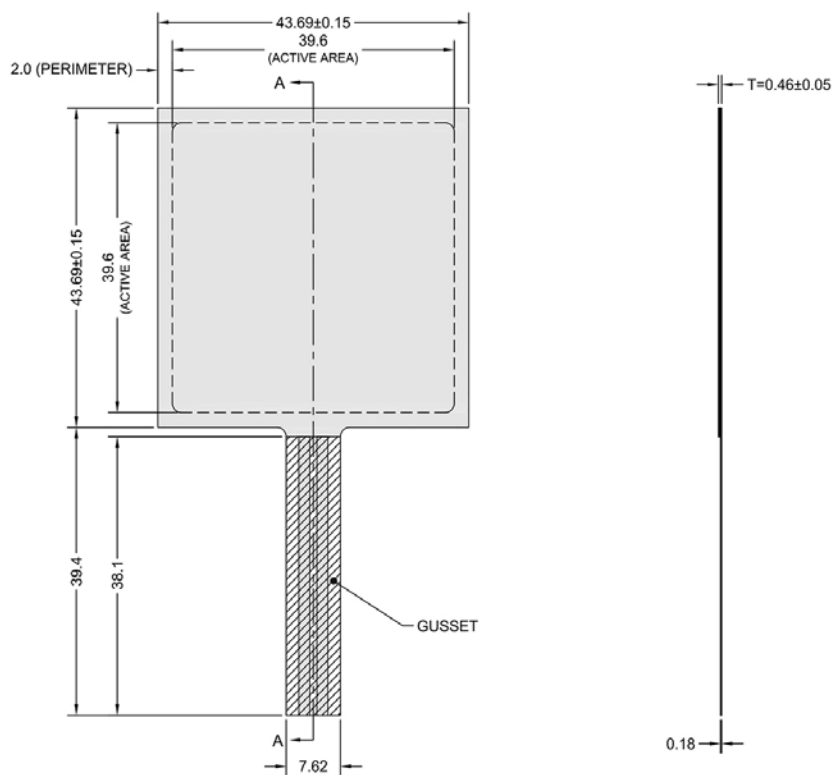

Exploded View

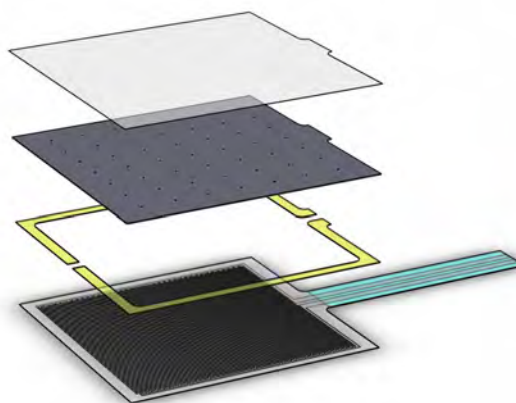

Model 408:

Active Area: XXXmm x 10.2mm
Nominal Thickness: 0.41mm
Switch Travel: 0.15mm

Sensor Mechanical Data

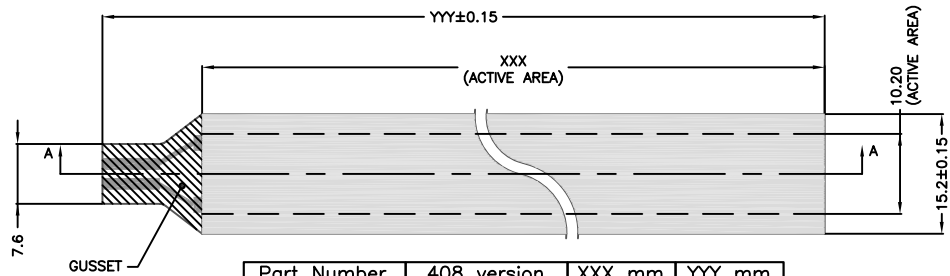

Part Number	408 version	XXX mm	YYY mm
34-00068	408-50	50.00	62.70
34-00069	408-100	100.00	112.70
34-00070	408-200	200.00	212.70
34-00071	408-300	300.00	312.70
34-00072	408-400	400.00	412.70
34-00073	408-500	500.00	512.70
30-61710	408	609.60	622.30

Available Part Numbers:

- PN: 34-00010 Model 408
- No contacts or solder tabs
- PN: 34-75319 Model 408
- with female contacts
- PN: 34-23845 Model 408
- with female contacts and housing
- PN: 30-61710 Model 408
- with solder tabs
- PN: 34-00068 Model 408-50
- 50mm with solder tabs
- PN: 34-00069 Model 408-100
- 100mm with solder tabs
- PN: 34-00070 Model 408-200
- 200mm with solder tabs
- PN: 34-00071 Model 408-300
- 300mm with solder tabs
- PN: 34-00072 Model 408-400
- 400mm with solder tabs
- PN: 34-00073 Model 408-500
- 500mm with solder tabs



SECTION A-A
LAYERS STACK-UP

Exploded View

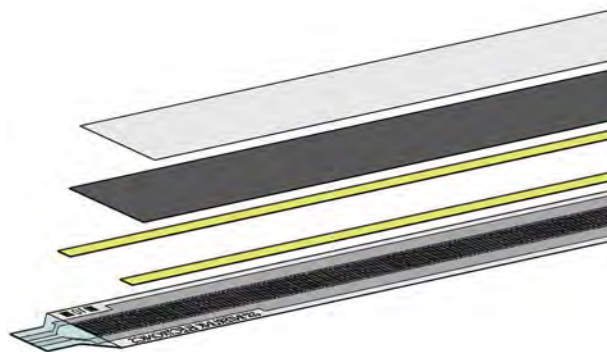

Contact Us

United States Corporate Office
Interlink Electronics, Inc.
31248 Oak Crest Drive
Suite 110
Westlake Village, CA 91361 USA
Phone: +1 (805) 484-8855
Fax: +1 (805) 484-9457
www.interlinkelectronics.com
Sales & Support: sales@iefsr.com