

OLGA-S

~11° spot beam beam. Assembly with holder and installation tape.

TECHNICAL SPECIFICATIONS:

Dimensions	Ø 32.0 mm
Height	19.1 mm
Fastening	tape, pin
Colour	black
Box size	476 x 273 x 292 mm
Box weight	9.8 kg
Quantity in Box	792 pcs
ROHS compliant	yes ⓘ



MATERIAL SPECIFICATIONS:

Component	Type	Material	Colour
OLGA-S	Lens	PMMA	clear
OLGA-HLD	Holder	PC	black
SPUTNIK-TAPE3	Tape	PU tape	black

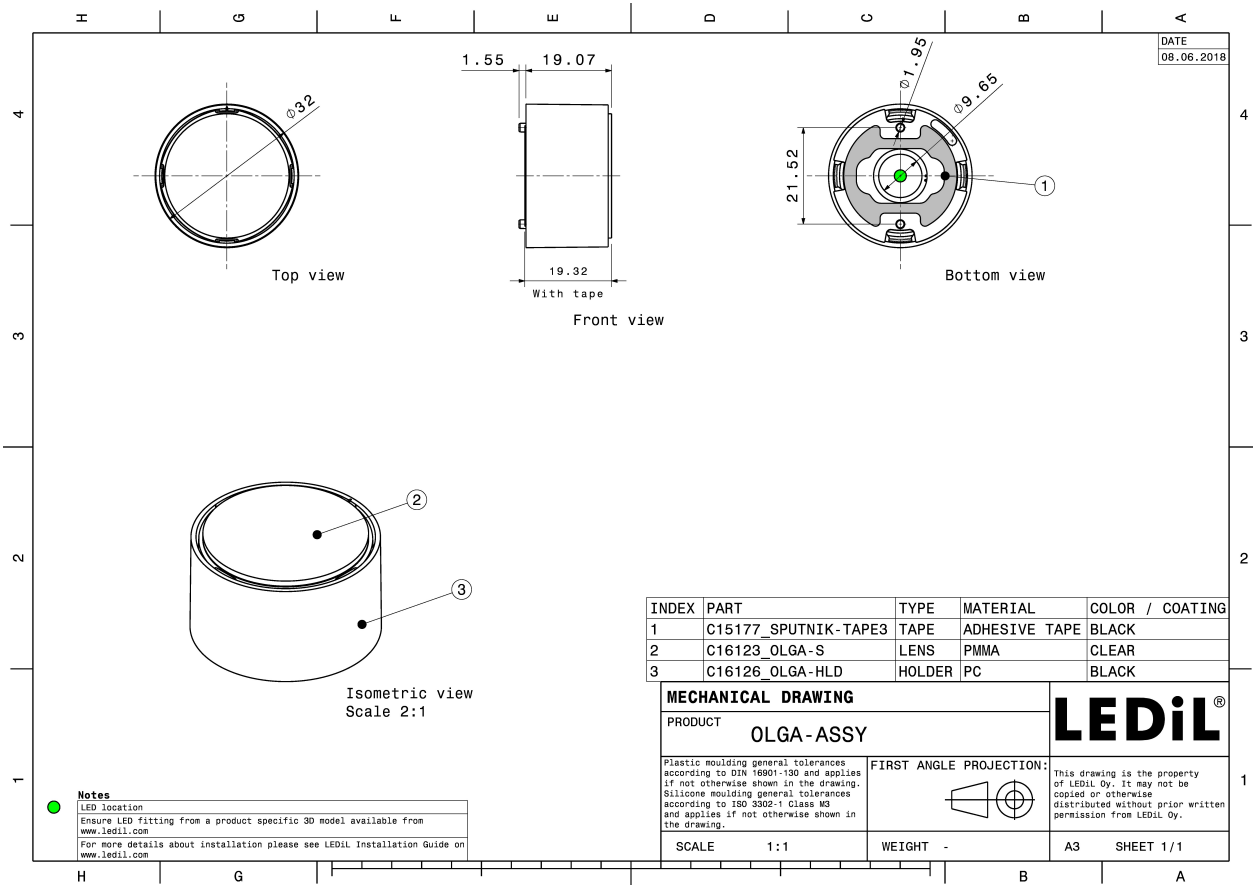

PHOTOMETRIC DATA (MEASURED):

CREE 

LED XD16
FWHM 13.0°
Efficiency 82 %
Peak intensity 10.400 cd/lm
Required components:

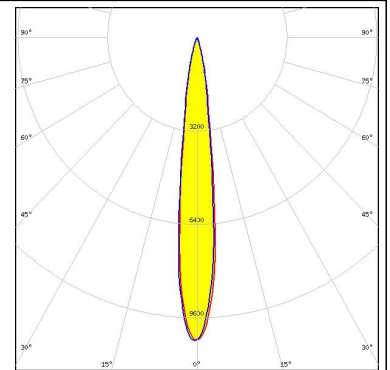
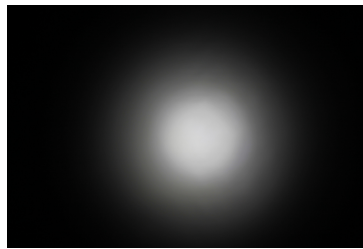

CREE 

LED XHP35 HI
FWHM 15.0°
Efficiency 87 %
Peak intensity 8.500 cd/lm
Required components:

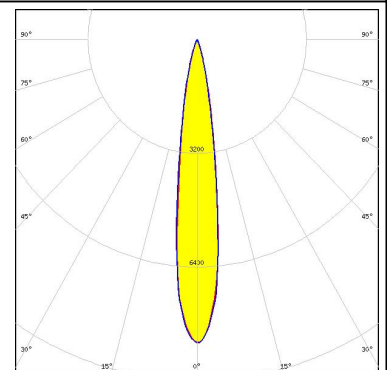
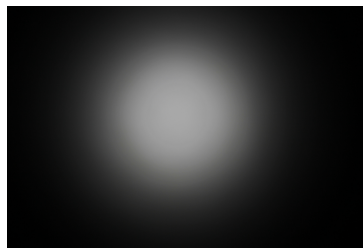

CREE 

LED XP-E2
FWHM 11.0°
Efficiency 89 %
Peak intensity 13.600 cd/lm
Required components:

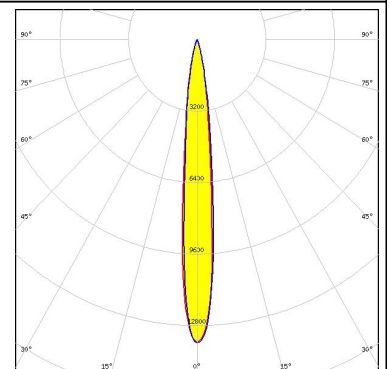
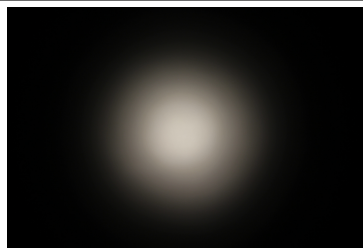

CREE 

LED XP-G2
FWHM 13.0°
Efficiency 87 %
Peak intensity 10.000 cd/lm
Required components:

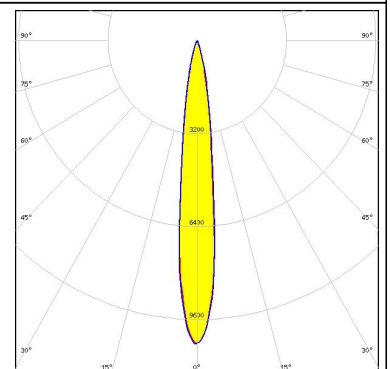

PHOTOMETRIC DATA (MEASURED):



LED XP-L HI
 FWHM 14.0°
 Efficiency 88 %
 Peak intensity 10.200 cd/lm
 Required components:

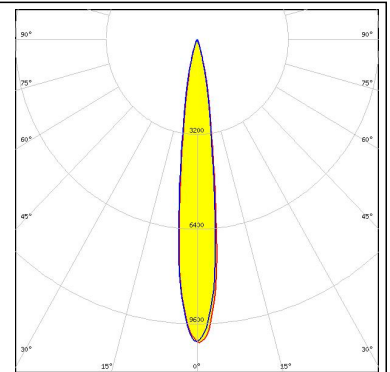
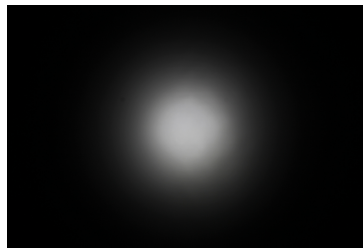

LED XQ-E HI
 FWHM 11.0°
 Efficiency 86 %
 Peak intensity 13.600 cd/lm
 Required components:

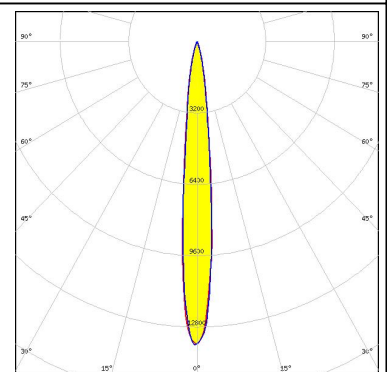

LED LUXEON C
 FWHM 11.0°
 Efficiency 84 %
 Peak intensity 11.600 cd/lm
 Required components:

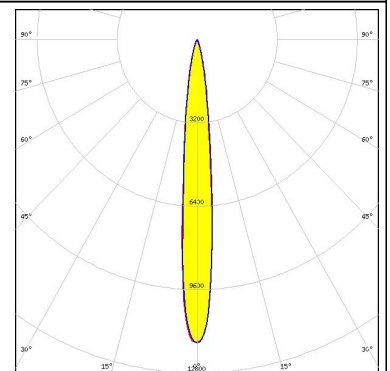
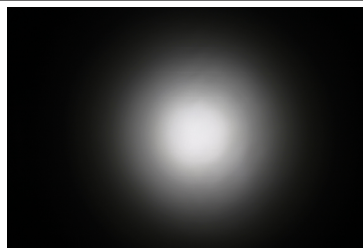

LED LUXEON CZ
 FWHM 11.0°
 Efficiency 89 %
 Peak intensity 14.800 cd/lm
 Required components:

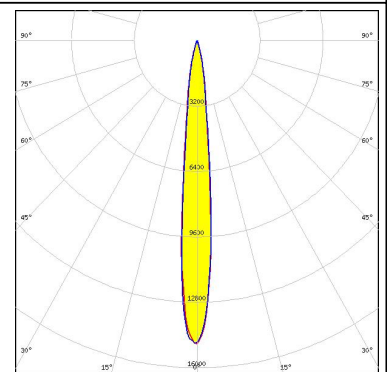
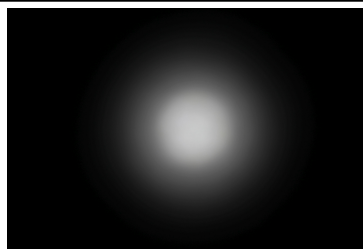

PHOTOMETRIC DATA (MEASURED):

LUMILEDS

LED LUXEON M/MX
FWHM 24.0°
Efficiency 84 %
Peak intensity 3.800 cd/lm
Required components:

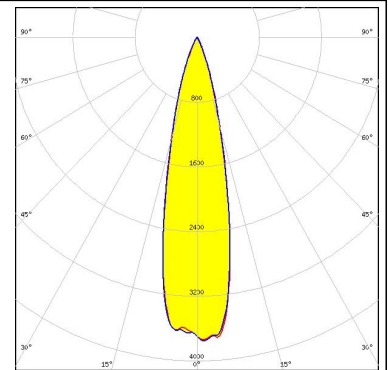

LUMILEDS

LED LUXEON V
FWHM 18.0°
Efficiency 84 %
Peak intensity 6.500 cd/lm
Required components:

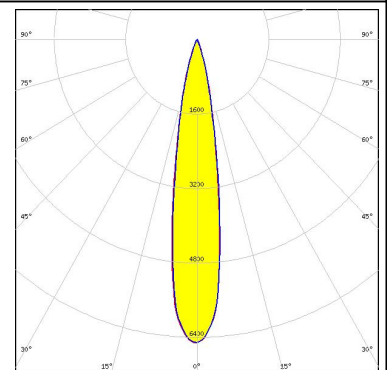
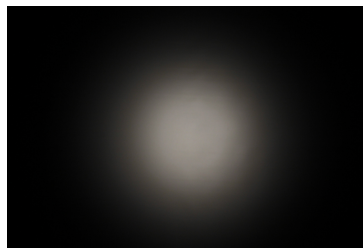

NICHIA

LED NVSW219D
FWHM 14.0°
Efficiency 85 %
Peak intensity 9.300 cd/lm
Required components:

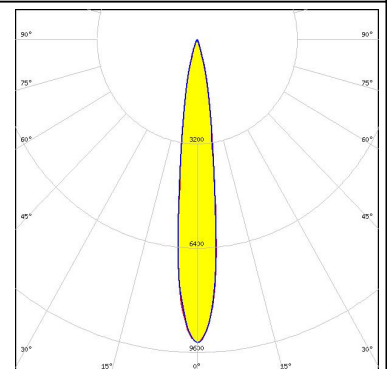
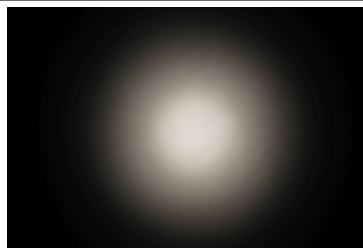

OSRAM Opto Semiconductors

LED Duris S8
FWHM 24.0°
Efficiency 86 %
Peak intensity 4.300 cd/lm
Required components:

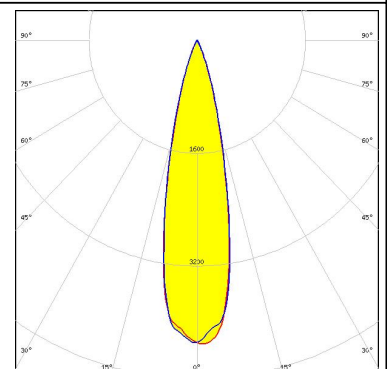
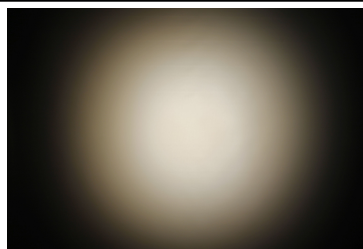

PHOTOMETRIC DATA (MEASURED):

OSRAM
Opto Semiconductors

LED Oslon Black Flat
FWHM 11.0°
Efficiency 88 %
Peak intensity 16.000 cd/lm
Required components:

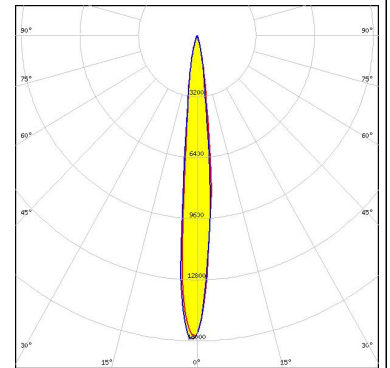
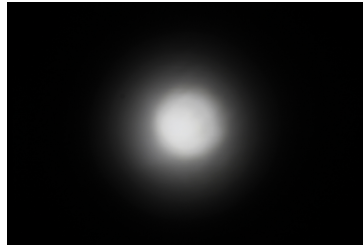

OSRAM
Opto Semiconductors

LED Oslon Square EC
FWHM 13.0°
Efficiency 85 %
Peak intensity 10.000 cd/lm
Required components:

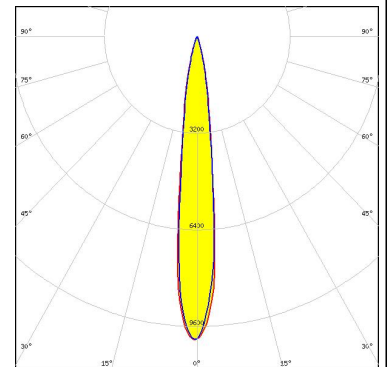

OSRAM
Opto Semiconductors

LED Oslon Square Gen3
FWHM 14.0°
Efficiency 87 %
Peak intensity 10.200 cd/lm
Required components:

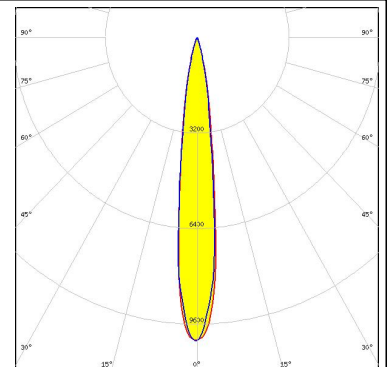
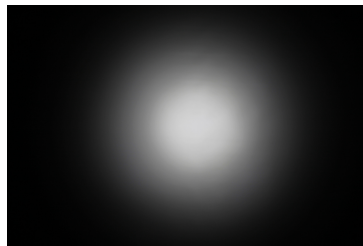

OSRAM
Opto Semiconductors

LED Oslon SSL 150
FWHM 11.0°
Efficiency 87 %
Peak intensity 13.000 cd/lm
Required components:

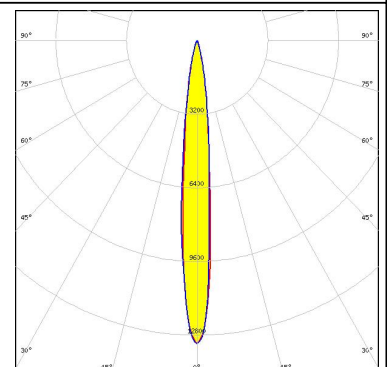

PHOTOMETRIC DATA (MEASURED):

SAMSUNG

LED LH181B
FWHM 15.0°
Efficiency 87 %
Peak intensity 9.700 cd/lm
Required components:

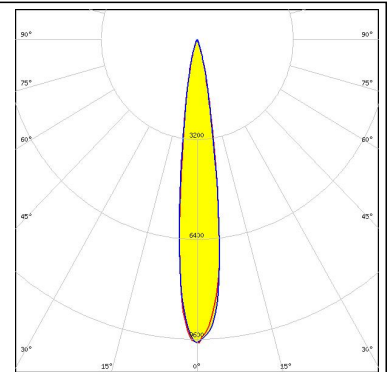
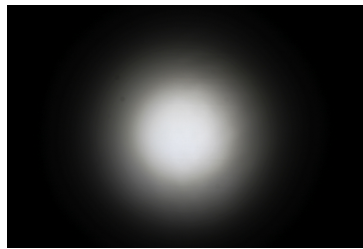

SAMSUNG

LED LH351B
FWHM 14.0°
Efficiency 87 %
Peak intensity 9.300 cd/lm
Required components:

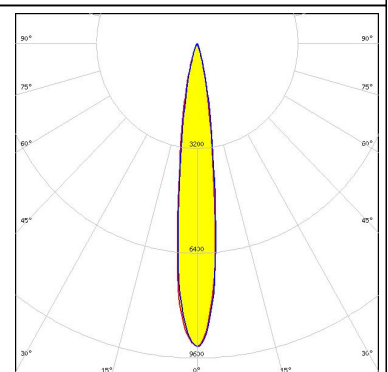
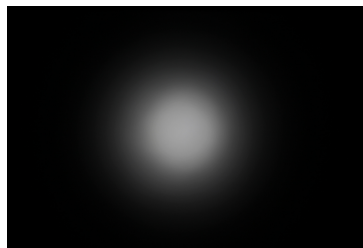

SAMSUNG

LED LM302A
FWHM 14.0°
Efficiency 89 %
Peak intensity 9.900 cd/lm
Required components:

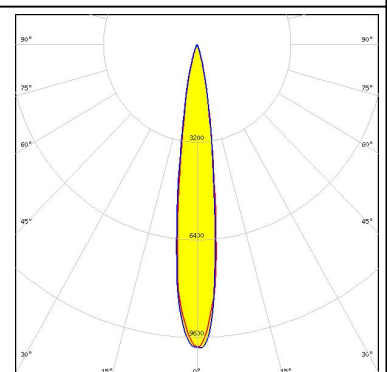
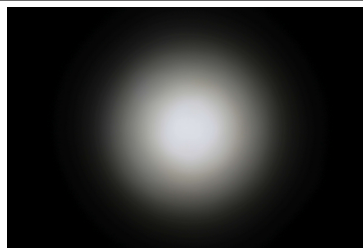

PHOTOMETRIC DATA (SIMULATED):



LED XHP50
FWHM 23.0°
Efficiency 86 %
Peak intensity 4.639 cd/lm
Required components:

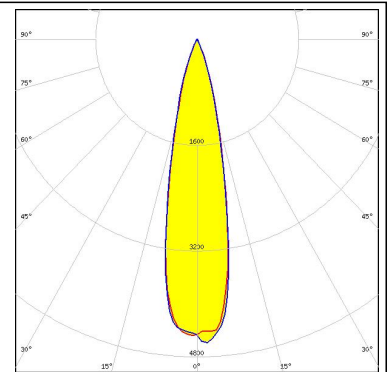

LED LUXEON MZ
FWHM 18.0°
Efficiency 90 %
Peak intensity 7.594 cd/lm
Required components:

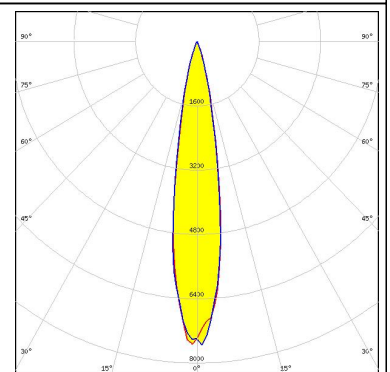

LED NFMW48xA
FWHM 21.0°
Efficiency 89 %
Peak intensity 5.460 cd/lm
Required components:

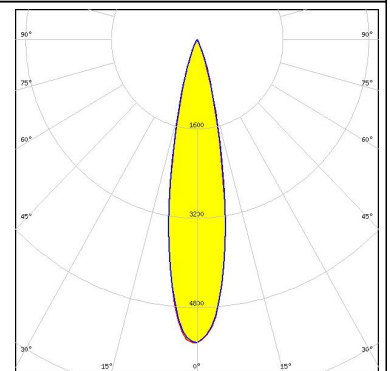

GENERAL INFORMATION:

NOTE: The typical beam angle will be changed by different color, chip size and chip position tolerance. The typical total beam angle is the full angle measured where the luminous intensity is half of the peak value.

MATERIALS:

As part of our continuous research and improvement processes, and to ensure the best possible quality and availability of our products, LEDiL reserves the right to change material grades without notice.

PRODUCT DATA USER AGREEMENT AND DISCLAIMER:

The measured data in the provided downloadable LEDiL Product Datasheets and Mechanical 2D-Drawings is rounded and provided as reference for planning. LEDiL Oy's optical specifications have been verified by conducting performance testing of the products in accordance with the company's quality system. The reported data are averaged results of multiple measurements with typical variation. LEDiL Oy reserves the right to without prior notification make changes and improvements to its products.

LEDiL Oy assumes neither warranty, nor guarantee nor any other liability of any kind for the contents and correctness of the provided data. The provided data has been generated with highest diligence but the provided data may in reality not represent the complete possible variation range of all intrinsic parameters. Therefore, in certain cases a deviation from the provided data could occur.

LEDiL Oy reserves the right to undertake technical changes of its products without further notification which could lead to changes in the provided data. LEDiL Oy assumes no liability of any kind for the possible deviation from any provided data or any other damage resulting from the usage of the provided data.

The user agrees to this disclaimer and user agreement with the download or usage of the provided files.

LEDiL Oy

Joensuunkatu 13
FI-24240 SALO
Finland

LEDiL Inc.

228 West Page Street
Suite D
Sycamore IL 60178
USA

Local sales and technical support

[www.ledil.com/
where_to_buy](http://www.ledil.com/where_to_buy)

Shipping locations

Salo, Finland
Hong Kong, China

Distribution Partners

[www.ledil.com/
where_to_buy](http://www.ledil.com/where_to_buy)