

### DESCRIPTION

The MPM3820 is a step-down module converter with built-in power MOSFETs and inductor. The DC-DC module comes in a small surface-mount QFN-20(3mm x 5mm x 1.6mm) package and achieves 2A continuous output current from a 2.7V to 6V input voltage with excellent load and line regulation. The MPM3820 is ideal for powering portable equipment that runs from a single cell Lithium-Ion (Li+) Battery. The output voltage is regulated as low as 0.6V. Only FB resistors and input and output capacitors are needed to complete the design.

The Constant-on-time control (COT) scheme provides fast transient response, high light-load efficiency and easy loop stabilization.

Fault condition protection includes cycle-by-cycle current limit and thermal shutdown (TSD).

The MPM3820 requires a minimum number of readily available standard external components and is available in an ultra-small QFN-20 (3mmx5mm) package.

### FEATURES

- Wide 2.7V to 6V Operating Input Range
- Adjustable Output from 0.6V
- 3.0mm x 5.0mm x 1.6mm QFN-20 Package
- Total Solution Size 8.5mm x 4.5 mm
- Low Radiated Emissions (EMI) Complies with EN55022 Class B Standard
- Up to 2A Continuous Output Current
- 100% Duty Cycle in Dropout
- Ultra Low IQ: 40µA
- EN and Power Good for Power Sequencing
- Cycle-by-Cycle Over-Current Protection
- Short-Circuit Protection with Hiccup Mode
- Adjustable Output Only Needs 4 External Components : 2 Ceramic Capacitors and FB Divider Resistors

### APPLICATIONS

- Low Voltage I/O System Power
- LDO Replacement
- Power for Portable Products
- Storage (SSD/HDD)
- Space-Limited Applications

All MPS parts are lead-free and adhere to the RoHS directive. For MPS green status, please visit MPS website under Products, Quality Assurance page.

"MPS" and "The Future of Analog IC Technology" are registered trademarks of Monolithic Power Systems, Inc.

### TYPICAL APPLICATION

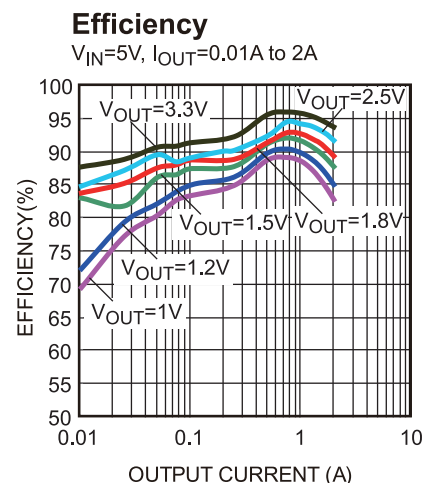
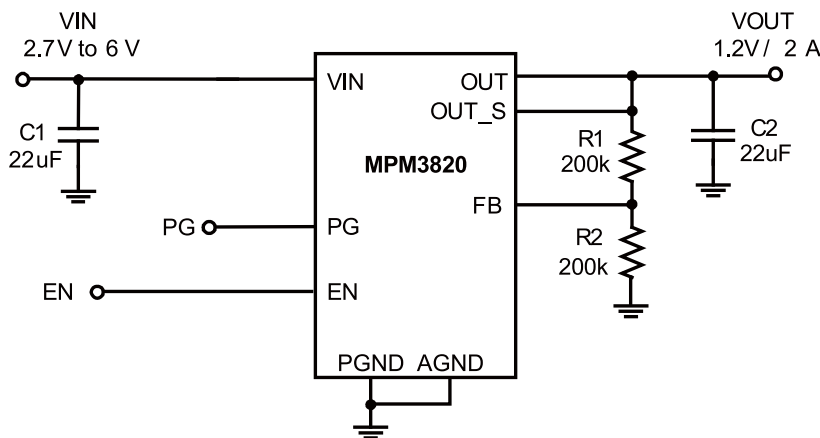

### ORDERING INFORMATION

Part Number*	Package	Top Marking
MPM3820GQV	QFN-20 (3mmx5mm)	3820 M

\* For Tape & Reel, add suffix -Z (e.g. MPM3820GQV-Z);

### PACKAGE REFERENCE

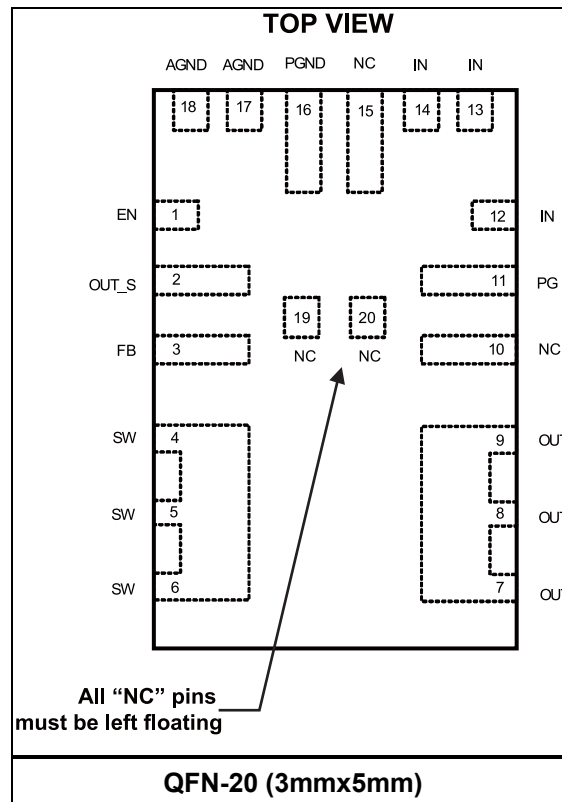

#### ABSOLUTE MAXIMUM RATINGS <sup>(1)</sup>

Supply Voltage $V_{IN}$ .....	6.5V
$V_{SW}$ .....	-0.3V (-6V for <10ns) to 6.5V (10V for <10ns)
All Other Pins .....	-0.3V to 6.5V
Junction Temperature .....	150°C
Lead Temperature .....	260°C
Continuous Power Dissipation ( $T_A = +25^\circ\text{C}$ ) <sup>(2)</sup>	2.8W
Storage Temperature .....	-65°C to +150°C

#### Recommended Operating Conditions <sup>(3)</sup>

Supply Voltage $V_{IN}$ .....	2.7V to 6V
Operating Junction Temp. ( $T_J$ ) .....	-40°C to +125°C

Thermal Resistance <sup>(4)</sup>	$\theta_{JA}$	$\theta_{JC}$
QFN-20 (3mmx5mm) .....	46	10 °C/W

#### Notes:

- 1) Exceeding these ratings may damage the device.
- 2) The maximum allowable power dissipation is a function of the maximum junction temperature  $T_J$  (MAX), the junction-to-ambient thermal resistance  $\theta_{JA}$ , and the ambient temperature  $T_A$ . The maximum allowable continuous power dissipation at any ambient temperature is calculated by  $P_D$  (MAX) =  $(T_J$  (MAX) -  $T_A$ ) /  $\theta_{JA}$ . Exceeding the maximum allowable power dissipation will cause excessive die temperature, and the regulator will go into thermal shutdown. Internal thermal shutdown circuitry protects the device from permanent damage.
- 3) The device is not guaranteed to function outside of its operating conditions.
- 4) Measured on JESD51-7, 4-layer PCB.

## ELECTRICAL CHARACTERISTICS

$V_{IN} = 3.6V$ ,  $T_J = -40^{\circ}C$  to  $+125^{\circ}C$ , Typical value is tested at  $T_J = +25^{\circ}C$ . The limit over temperature is guaranteed by characterization, unless otherwise noted.

Parameter	Symbol	Condition	Min	Typ	Max	Units
Feedback Voltage	$V_{FB}$	$2.7V \leq V_{IN} \leq 6V$	591	600	609	mV
Feedback Current	$I_{FB}$	$V_{FB} = 0.6V$		10		nA
PFET Switch-On Resistance	$R_{DSON\_P}$			55		m $\Omega$
NFET Switch-On Resistance	$R_{DSON\_N}$			45		m $\Omega$
Inductor L Value	L	Inductance value at 1MHz		1		$\mu$ H
Inductor DC Resistance	$R_{DCR}$			55		m $\Omega$
Dropout Resistance	$R_{DR}$	100% on duty		110		m $\Omega$
Switch Leakage		$V_{EN} = 0V$ , $V_{IN} = 6V$ $V_{SW} = 0V$ and $6V$ , $T_J = 25^{\circ}C$		0	2	$\mu$ A
PFET Peak Current Limit			3.4	4.1		A
NFET Valley Current Limit				3.7		A
NFET Switch Sinking Current	$I_{NSW}$	$V_{OUT} = 1.2V$ , $V_{FB} = 0.7V$		100		$\mu$ A
On Time	$T_{ON}$	$V_{IN} = 5V$ , $V_{OUT} = 1.2V$		200		ns
		$V_{IN} = 3.6V$ , $V_{OUT} = 1.2V$		280		
Switching Frequency	$F_s$	$V_{OUT} = 1.2V$	960	1200	1440	kHz
Minimum Off Time	$T_{MIN-OFF}$			30		ns
Minimum On Time <sup>(5)</sup>	$T_{MIN-ON}$			50		ns
Soft-Start Time	$T_{SS-ON}$			1.5		ms
Soft-Stop Time	$T_{SS-OFF}$			1		ms
Power Good Upper Trip Threshold		FB Voltage in Respect to the Regulation		+10		%
Power Good Lower Trip Threshold				-10		%
Power Good Delay				90		$\mu$ s
Power Good Sink Current Capability	$V_{PG\_LO}$	Sink 1mA			0.4	V
Power Good Logic High Voltage	$V_{PG\_HI}$	$V_{IN} = 5V$ , $V_{FB} = 0.6V$	4.9			V
Power Good Internal Pull Up Resistor	$R_{PG}$			500		k $\Omega$
Under Voltage Lockout Threshold Rising			2.35	2.5	2.65	V
Under Voltage Lockout Threshold Hysteresis				400		mV
EN Input Logic Low Voltage					0.35	V
EN Input Logic High Voltage			1.2			V
EN Input Current		$V_{EN} = 2V$		2		$\mu$ A
		$V_{EN} = 0V$		0		$\mu$ A

**ELECTRICAL CHARACTERISTICS (continued)**

$V_{IN} = 3.6V$ ,  $T_J = -40^{\circ}C$  to  $+125^{\circ}C$ , Typical value is tested at  $T_J = +25^{\circ}C$ . The limit over temperature is guaranteed by characterization, unless otherwise noted.

Parameter	Symbol	Condition	Min	Typ	Max	Units
Supply Current (Shutdown)		$V_{EN}=0V$ , $T_J=25^{\circ}C$		0	1	$\mu A$
Supply Current (Quiescent)		$V_{EN}=2V$ , $V_{FB}=0.63V$ , $V_{IN}=3.6V$		40		$\mu A$
Thermal Shutdown <sup>(5)</sup>				160		$^{\circ}C$
Thermal Hysteresis <sup>(5)</sup>				30		$^{\circ}C$

**Notes:**

5) Guaranteed by design.

## TYPICAL PERFORMANCE CHARACTERISTICS

$V_{IN} = 5V$ ,  $V_{OUT} = 1.2V$ ,  $C_{OUT} = 22\mu F$ ,  $T_A = +25^\circ C$ , unless otherwise noted.

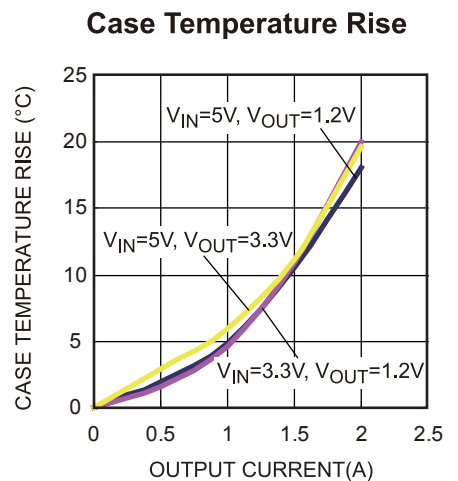
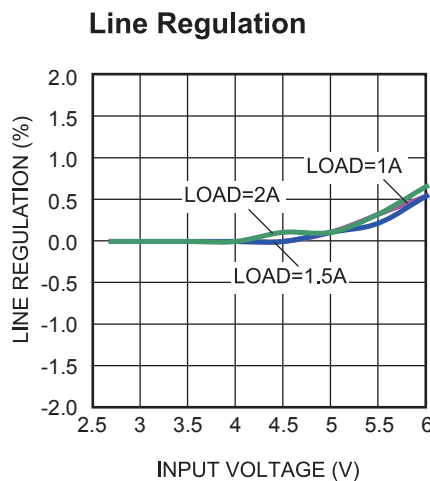
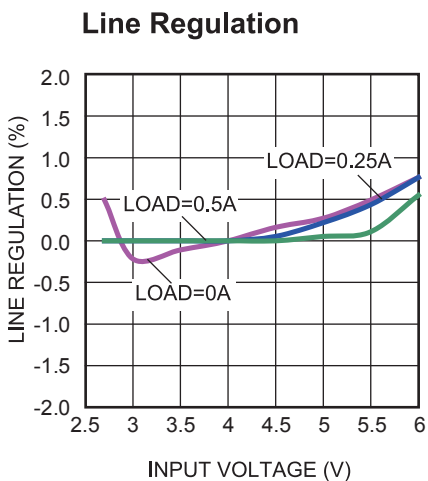
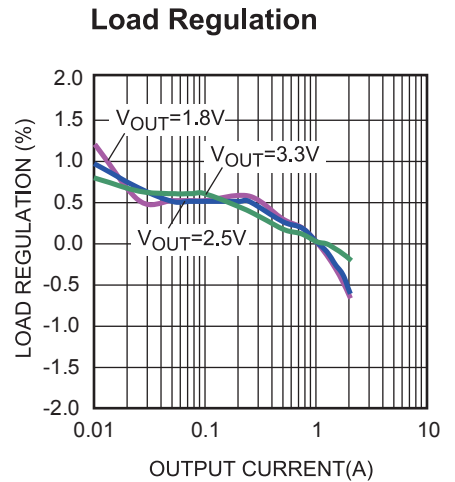
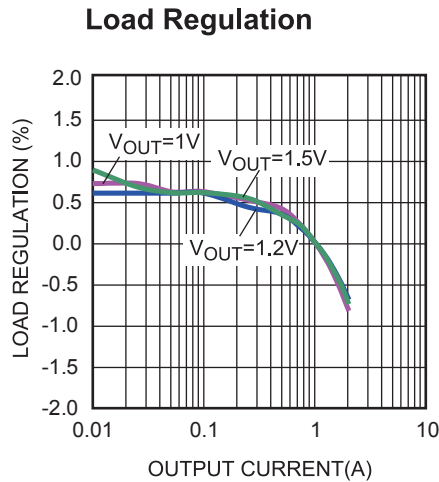
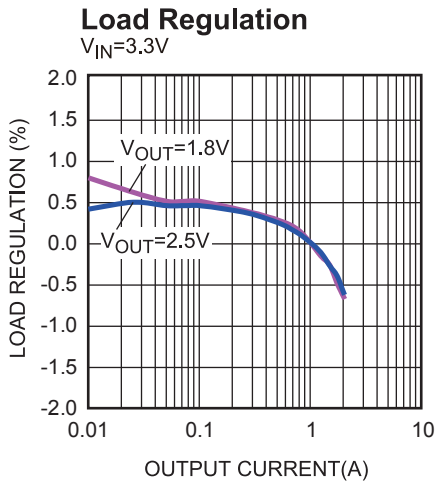
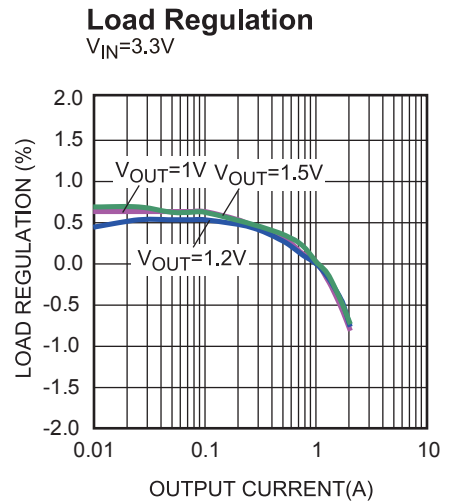
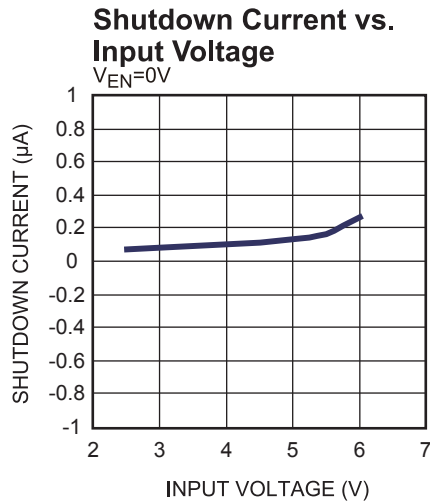
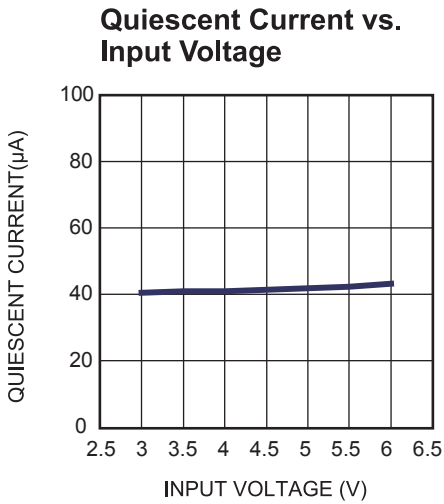

**TYPICAL PERFORMANCE CHARACTERISTICS (continued)**
 $V_{IN} = 5V, V_{OUT} = 1.2V, C_{OUT} = 22\mu F, T_A = +25^\circ C$ , unless otherwise noted.

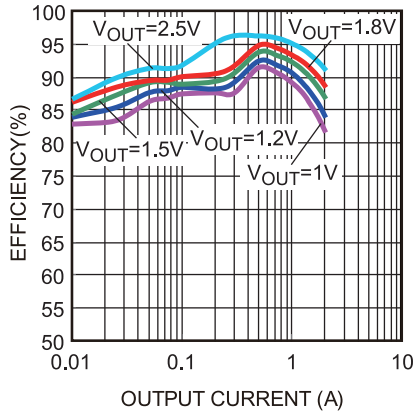
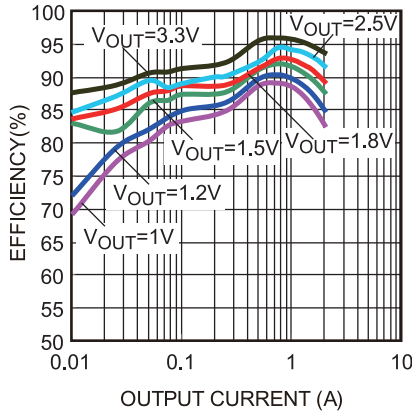
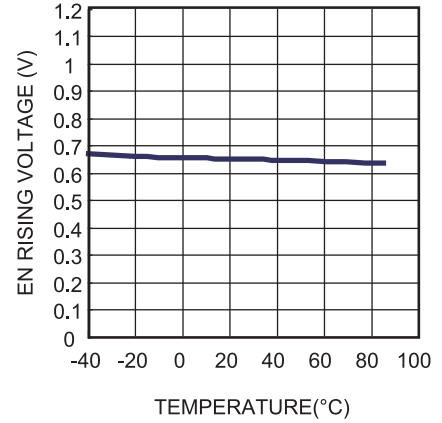
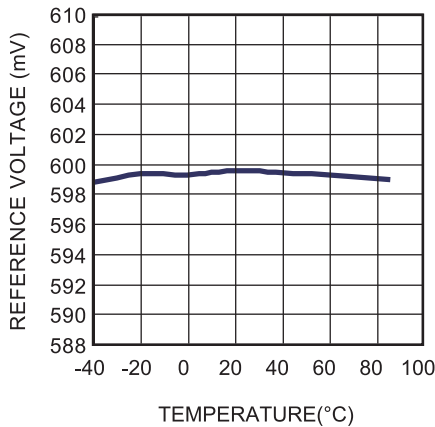
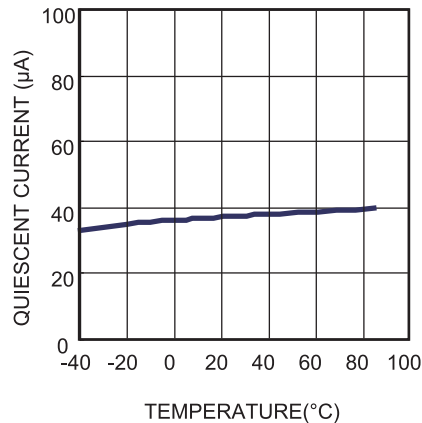
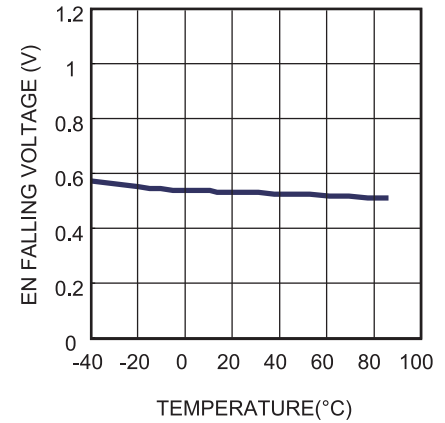
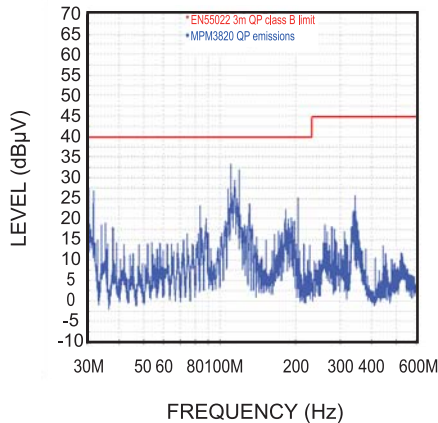
**Efficiency**
 $V_{IN} = 3.3V$ 

**Efficiency**

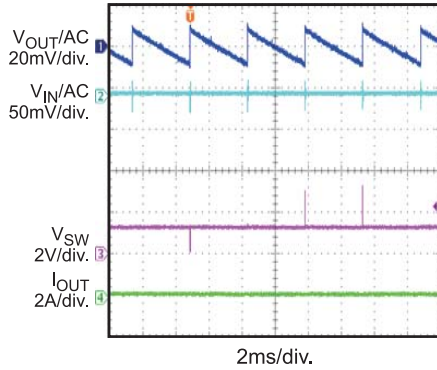
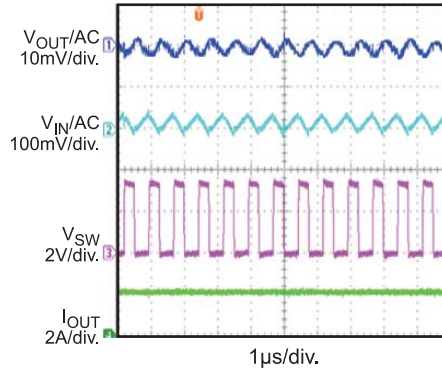
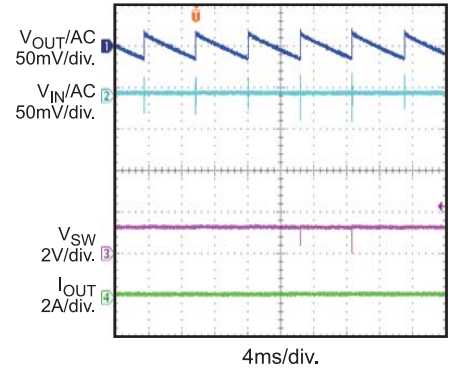
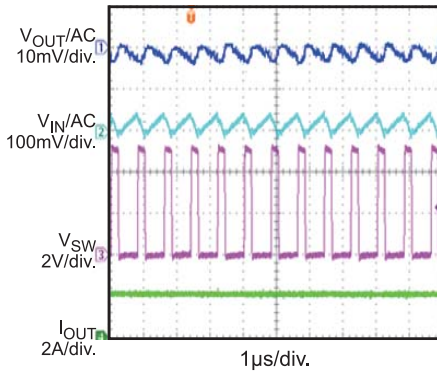
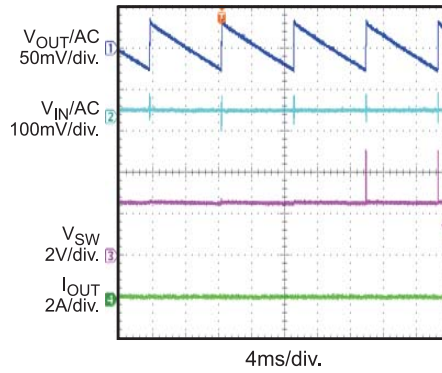
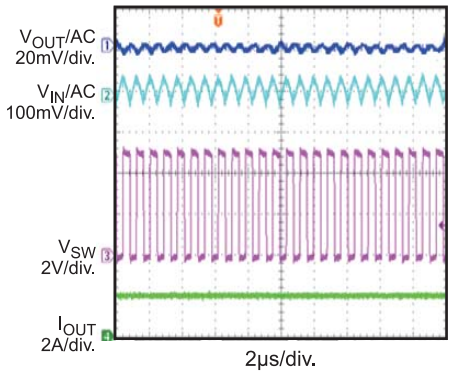
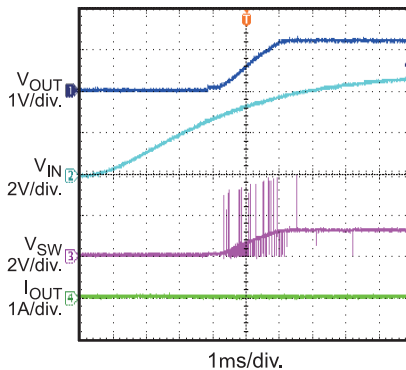
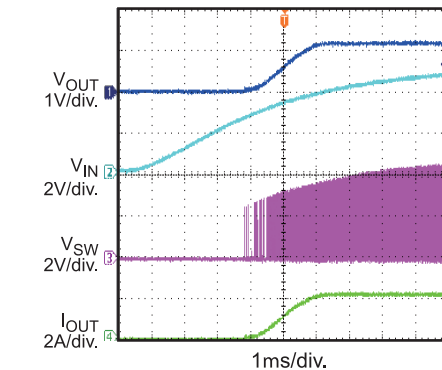
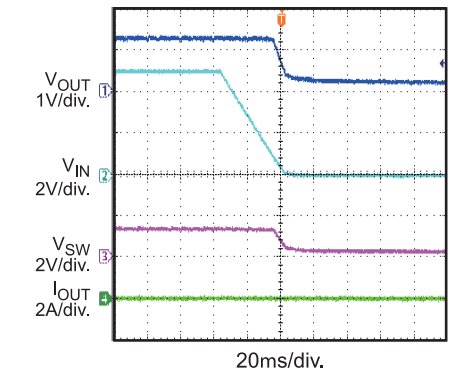
**EN Rising vs. Temperature**

**Reference Voltage vs. Temperature**

**Quiescent Current vs. Temperature**

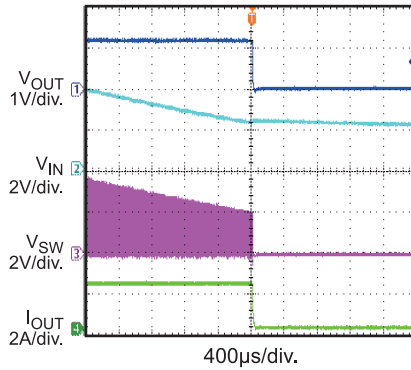
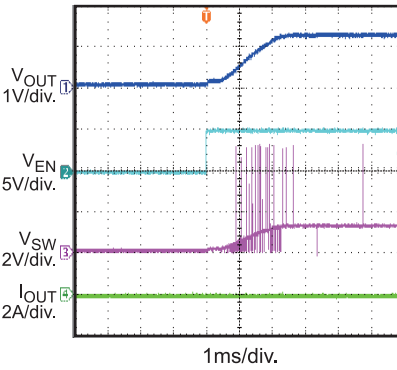
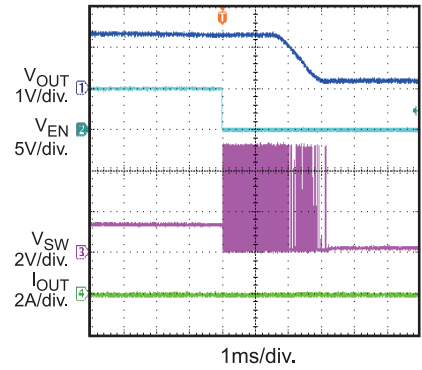
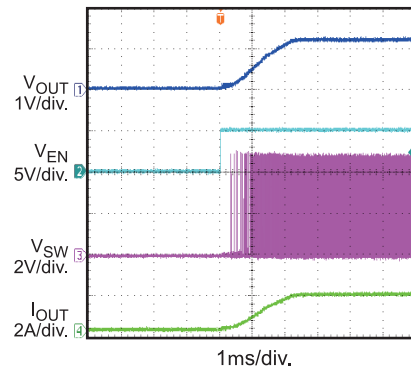
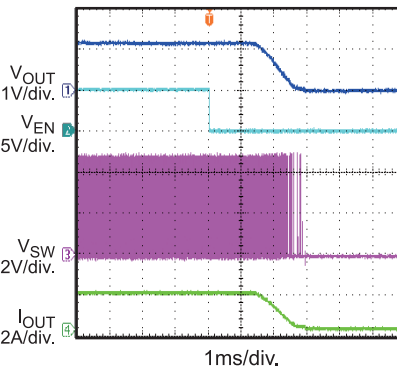
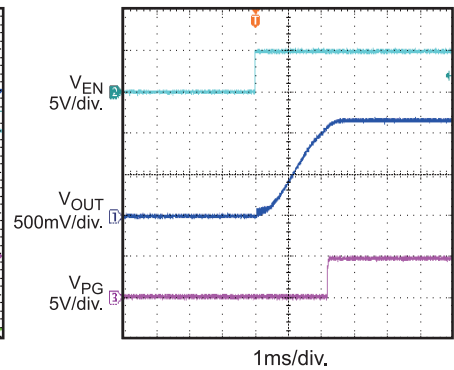
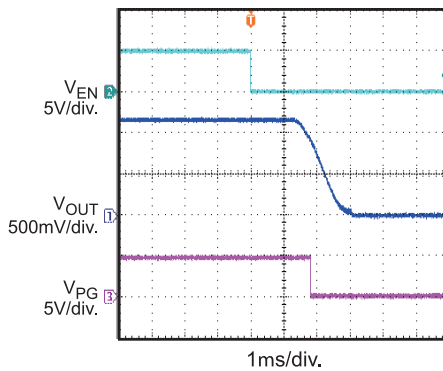
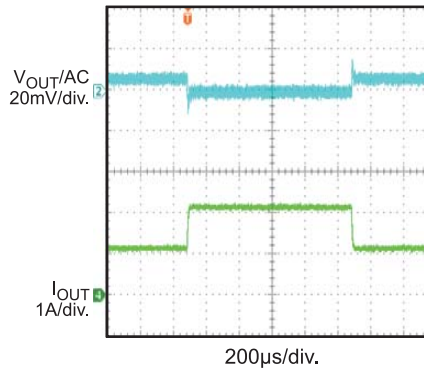
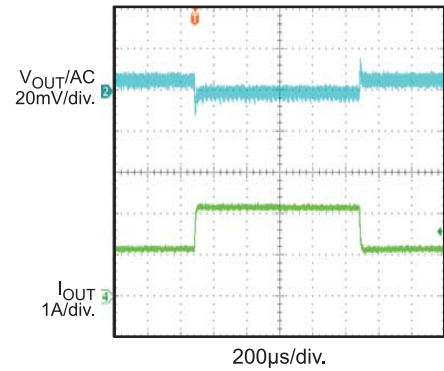
**EN Falling vs. Temperature**

**Radiated Emission**
 $I_{OUT} = 2A, C_{OUT} = 22\mu F \times 2$ 

**TYPICAL PERFORMANCE CHARACTERISTICS (continued)**
 $V_{IN} = 5V, V_{OUT} = 1.2V, C_{OUT} = 22\mu F, T_A = +25^\circ C$ , unless otherwise noted.

**Output Ripple**
 $V_{IN} = 3.3V, V_{OUT} = 1.2V, I_{OUT} = 0A$ 

**Output Ripple**
 $V_{IN} = 3.3V, V_{OUT} = 1.2V, I_{OUT} = 2A$ 

**Output Ripple**
 $V_{IN} = 5V, V_{OUT} = 1.2V, I_{OUT} = 0A$ 

**Output Ripple**
 $V_{IN} = 5V, V_{OUT} = 1.2V, I_{OUT} = 2A$ 

**Output Ripple**
 $V_{IN} = 5V, V_{OUT} = 3.3V, I_{OUT} = 0A$ 

**Output Ripple**
 $V_{IN} = 5V, V_{OUT} = 3.3V, I_{OUT} = 2A$ 

**V<sub>IN</sub> Power Up without Load**

**V<sub>IN</sub> Power Up with 2A Load**

**V<sub>IN</sub> Shutdown without Load**



**TYPICAL PERFORMANCE CHARACTERISTICS (continued)**
 $V_{IN} = 5V, V_{OUT} = 1.2V, C_{OUT} = 22\mu F, T_A = +25^\circ C$ , unless otherwise noted.

 **$V_{IN}$  Shutdown  
with 2A Load**

**EN Startup  
without Load**

**EN Shutdown  
without Load**

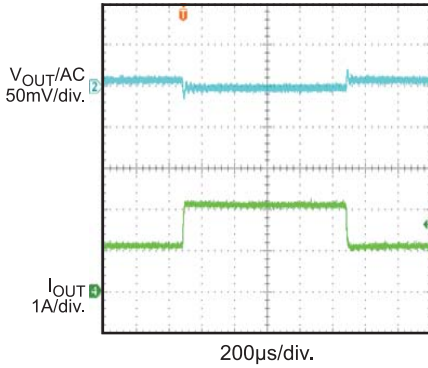
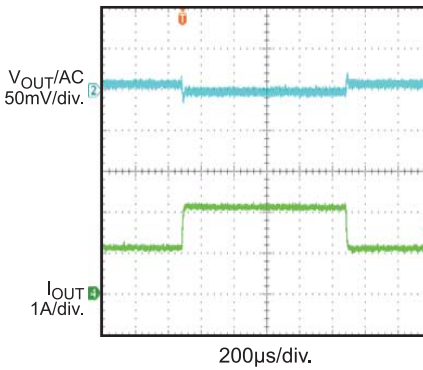
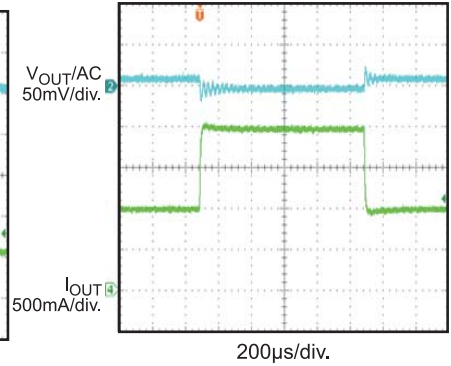
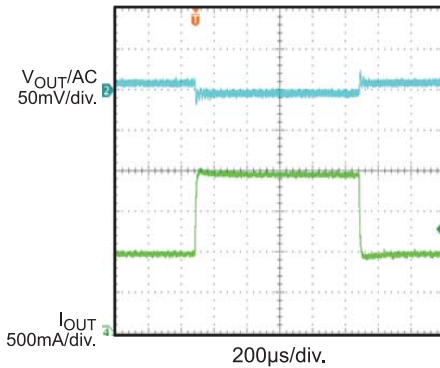
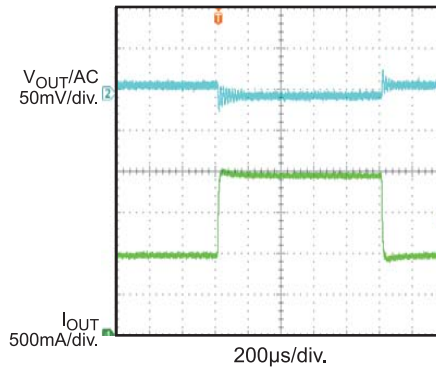
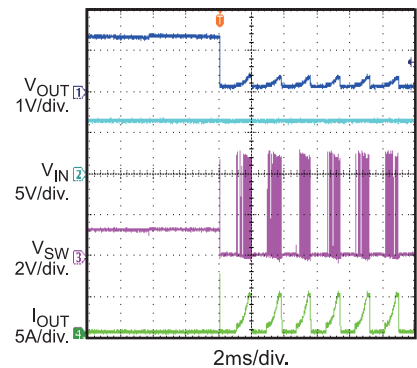
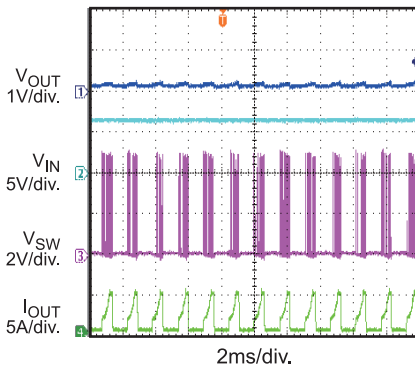
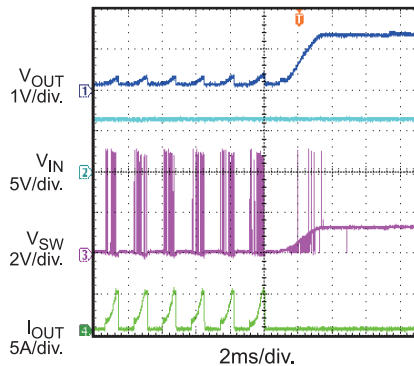
**EN Startup  
with 2A Load**

**EN Shutdown  
with 2A Load**

**Power Good  
Through EN Startup**

**Power Good  
Through EN Shutdown**

**Transient Response**
 $V_{IN} = 3.3V, V_{OUT} = 1V,$   
 $I_{OUT} = 1A-2A, 0.25A/\mu s$ 

**Transient Response**
 $V_{IN} = 5V, V_{OUT} = 1V,$   
 $I_{OUT} = 1A-2A, 0.25A/\mu s$ 



**TYPICAL PERFORMANCE CHARACTERISTICS (continued)**
 $V_{IN} = 5V, V_{OUT} = 1.2V, C_{OUT} = 22\mu F, T_A = +25^\circ C$ , unless otherwise noted.

**Transient Response**
 $V_{IN} = 3.3V, V_{OUT} = 1.8V,$   
 $I_{OUT} = 1A-2A, 0.25A/\mu s$ 

**Transient Response**
 $V_{IN} = 5V, V_{OUT} = 1.8V,$   
 $I_{OUT} = 1A-2A, 0.25A/\mu s$ 

**Transient Response**
 $V_{IN} = 3.3V, V_{OUT} = 2.5V,$   
 $I_{OUT} = 1A-2A, 0.25A/\mu s$ 

**Transient Response**
 $V_{IN} = 5V, V_{OUT} = 2.5V,$   
 $I_{OUT} = 1A-2A, 0.25A/\mu s$ 

**Transient Response**
 $V_{IN} = 5V, V_{OUT} = 3.3V,$   
 $I_{OUT} = 1A-2A, 0.25A/\mu s$ 

**Short-Circuit Entry**

**Short Circuit**

**Short-Circuit Recovery**

## PIN FUNCTIONS

Pin #	Name	Description
1	EN	On/Off Control.
2	OUT_S	Output Voltage Sense.
3	FB	Feedback. An external resistor divider from the output to GND (tapped to the FB), sets the output voltage.
4,5,6	SW	Switch Output.
7,8,9	OUT	Power Output.
11	PG	Power Good Indicator. The output of PG is an open drain with an internal pull up resistor to IN. PG is pulled up to IN when the FB voltage is within 10% of the regulation level, otherwise PG is low.
12,13,14	IN	Supply Voltage to Internal Control Circuitry.
16	PGND	Power Ground.
17, 18	AGND	Analogy Ground for Controller Circuits.
10, 15, 19, 20	NC	DO NOT CONNECT. Pin must be left floating.

### FUNCTIONAL BLOCK DIAGRAM

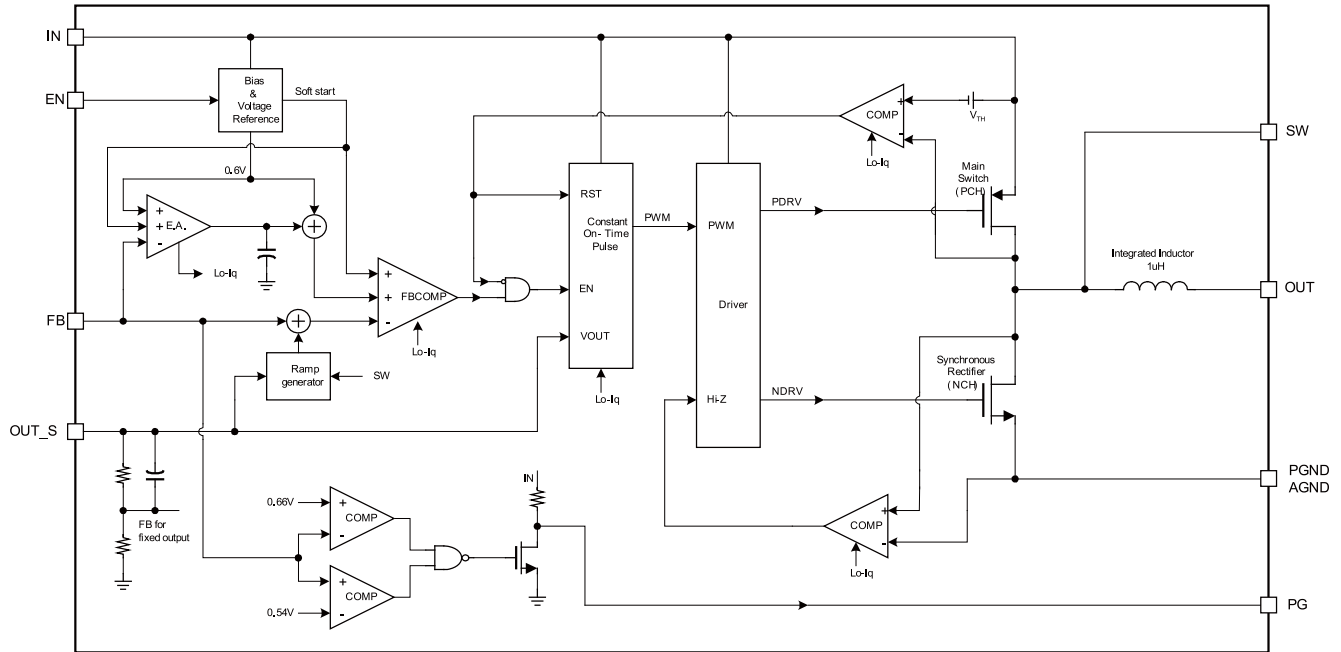

Figure 1: Functional Block Diagram

## OPERATION

The DC-DC module has a small surface-mount QFN-20(3mm x 5mm x 1.6mm) package. The module's integrated inductor simplifies the schematic and layout design. Only FB resistors and input and output capacitors are needed to complete the design. MPM3820 uses constant on-time control (COT) with input voltage feed forward to stabilize the switching frequency over a full-input range. At light load, MPM3820 employs a proprietary control of the low-side switch and inductor current on switching node and improve efficiency.

### Constant On-Time Control (COT)

Compared to a fixed-frequency PWM control, constant on-time control (COT) offers the advantage of a simpler control loop and faster transient response. Using input voltage feed forward, the MPM3820 maintains a nearly constant switching frequency across the input and output voltage range. The on-time of the switching pulse is estimated as follows:

$$T_{ON} = \frac{V_{OUT}}{V_{IN}} \times 0.833\mu s$$

To prevent inductor current run away during load transition, MPM3820 fixes the minimum off time to 30ns. However, this minimum off-time limit does not affect operation in a steady state.

### Light Load Operation

In a light-load condition, MPM3820 uses a proprietary control scheme to save power and improve efficiency. There is a zero current cross detect circuit (ZCD) to judge if the inductor current starts to reverse. When the inductor current touch ZCD threshold, the low side switch will start to be turned off.

The DCM mode happens only after low side switch turned off by ZCD circuit. Considering the ZCD circuit propagation time, the typical delay is 20ns. This means the inductor current continues to fall after the ZCD is triggered. If the inductor current falling slew rate is fast ( $V_o$  voltage is high or close to  $V_{in}$ ), the low-side MOSFET turns off (this means the inductor current may be negative). This does not allow the MPM3820 to enter DCM.

If DCM is required, the off-time of the low-side MOSFET in continuous conduction mode (CCM) should be longer than 40ns. It means the maximum duty is 95% to guarantee DCM mode at light load.

For example, if  $V_{in}$  is 3.4V and  $V_o$  is 3.3V, the off-time in CCM is 25ns. It is difficult to enter DCM at light load.

### Enable (EN)

If the input voltage is greater than the under-voltage lockout threshold (UVLO), typically 2.5V, MPM3820 is enabled by pulling EN above 1.2V. Leaving EN to float or be pulled down to ground disables MPM3820. There is an internal 1MΩ resistor from EN to ground.

### Soft Start/Stop

MPM3820 has a built-in soft-start that ramps up the output voltage in a controlled slew rate. This avoids overshoot at startup. The soft-start time is about 1.5ms typically.

At disable, MPM3820 ramps down the internal reference thus allow the load to linearly discharge the output. During soft stop time, the low side internal MOSFET will switch to control the slew rate of output voltage which follows the internal reference. Under light load and large output capacitor condition, the large energy stored in output capacitor will be transferred to input capacitor through the inductor. The topology is changed into a boost converter after  $V_{OUT}$  and  $V_{IN}$  role exchange. The boost voltage causes an overshoot on input capacitor; sometimes this overshoot is higher than the VABS (the ABSOLUTE maximum value) of input pin and can damage the IC. To prevent this situation, the input capacitor needs to be large enough to absorb this energy.

The energy stored in the output capacitor will be transferred to input capacitor. Consider the conduction loss on inductor, HS/LS MOS and so on, estimate 80% transfer efficiency of boost converter. Therefore the transferred energy can be calculated by below equation:

$$W_{BOOST} = 0.5 \times C_{OUT} \times V_{OUT}^2 \times 0.8$$

Where  $W_{\text{BOOST}}$  is the transferred energy,

$C_{\text{OUT}}$  is the output capacitor,

$V_{\text{OUT}}$  is output voltage.

To absorb this energy and protect the IC, we should guarantee the current input voltage plus the overshoot voltage cannot be higher than the  $V_{\text{ABS}}$  on input pin. The required minimum input capacitor can be calculated below:

$$C_{\text{IN(MIN)}} = 2 \times W_{\text{BOOST}} / (V_{\text{ABS}}^2 - V_{\text{IN}}^2)$$

Where  $C_{\text{IN(MIN)}}$  is the minimum input capacitor,  $V_{\text{ABS}}$  is the ABSOLUTE maximum value of input pin.

### Power Good Indicator (PGOOD)

MPM3820 has an open drain with a 500k $\Omega$  pull-up resistor pin for the power good indicator (PGOOD). When FB is within +/-10% of regulation voltage (i.e. 0.6V), PGOOD is pulled up to IN by the internal resistor. If FB voltage is out of the +/-10% window, PGOOD is pulled down to ground by an internal MOS FET. The MOS FET has a maximum  $R_{\text{dson}}$  of less than 100 $\Omega$ .

### Current Limit

MPM3820 has a typical 4.1A current limit for the high-side switch. When the high-side switch reaches the current limit, MPM3820 hits the hiccup threshold until the current decreases. This prevents the inductor current from continuing to build which results in damage to the components.

### Short Circuit and Recovery

MPM3820 enters short-circuit protection (SCP) mode when the current limit reached, then it tries to recover from the short circuit with hiccup mode. In SCP, MPM3820 disables the output power stage, discharges the soft-start cap and then automatically tries to soft-start again. If the short circuit remains after the soft-start ends, MPM3820 repeats the cycle until the short circuit disappears, and the output rises back to the regulation level.

## APPLICATION INFORMATION

### COMPONENT SELECTION

#### Setting the Output Voltage

The external resistor divider is used to set the output voltage (see Typical Application on page 1). The feedback resistor R1 cannot be too large or too small considering the trade-off for stability and dynamics. Choose R1 between 50kΩ to 200kΩ. R2 is given by:

$$R2 = \frac{R1}{\frac{V_{out}}{0.6} - 1}$$

The feedback circuit is shown in Figure 2.

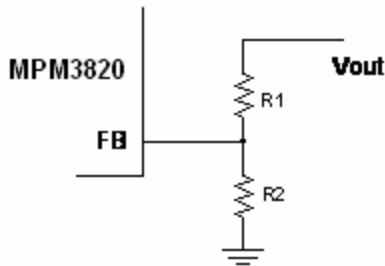

**Figure 2— Feedback Network**

Table 1 lists the recommended resistor values for common output voltages.

**Table 1—Resistor Values for Common Output Voltages**

V <sub>OUT</sub> (V)	R1 (kΩ)	R2 (kΩ)
1.0	200(1%)	300(1%)
1.2	200(1%)	200(1%)
1.8	200(1%)	100(1%)
2.5	200(1%)	63.2(1%)
3.3	200(1%)	44.2(1%)

#### Load Regulation Improvement

The load regulation of MPM3820 will be influenced by feedback resistor.

The relationship between V<sub>o</sub> and feedback network can be estimated as:

$$V_o \approx V_{FB} \times \frac{R_1 + R_2}{R_2} - I_o \times DCR \frac{R_1}{R_c}$$

The integrated inductor DCR is typical 55mΩ. The R<sub>c</sub> is internal compensation resistor, it's typical 1MΩ-1.2MΩ.

Base on the equation, to get better load regulation, decreasing the feedback resistor are the effective way. But too small feedback resistor will cause the steady problem.

For most applications, the 200kΩ R1 and 22μF output capacitor is sufficient, but for better load regulation, 100kΩ R1 and 2x22μF output capacitors are suggested.

Table 2 lists the recommended resistors and output capacitors value for better load regulation.

**Table 2—Resistor and Capacitor Selection for Better Load Regulation**

V <sub>OUT</sub> (V)	R1 (kΩ)	R2 (kΩ)	Cout(μF)
1.0	100(1%)	150(1%)	44
1.2	100(1%)	100(1%)	44
1.8	150(1%)	75(1%)	44
2.5	200(1%)	63.2(1%)	44
3.3	200(1%)	44.2(1%)	44

#### Selecting the Input Capacitor

The input current to the step-down converter is discontinuous, therefore a capacitor is required to supply the AC current while maintaining the DC input voltage. For optimal performance, use low ESR capacitors. Ceramic capacitors with X5R or X7R dielectrics are highly recommended due to their low ESR and small temperature coefficients. For most applications, a 22μF capacitor is sufficient

Since the input capacitor absorbs the input switching current it requires an adequate ripple current rating. The RMS current in the input capacitor can be estimated by:

$$I_{C1} = I_{LOAD} \times \sqrt{\frac{V_{OUT}}{V_{IN}} \times \left(1 - \frac{V_{OUT}}{V_{IN}}\right)}$$

The worst case condition occurs at  $V_{IN} = 2V_{OUT}$ , where:

$$I_{C1} = \frac{I_{LOAD}}{2}$$

For simplification, choose the input capacitor that has a RMS current rating greater than half of the maximum load current.

The input capacitor can be electrolytic, tantalum or ceramic. When using electrolytic or tantalum capacitors, a small, high quality ceramic capacitor (i.e. 0.1 $\mu$ F), should be placed as close to the IC as possible. When using ceramic capacitors, check that they have enough capacitance to provide sufficient charge to prevent an excessive voltage ripple at input. The input-voltage ripple caused by capacitance is estimated by:

$$\Delta V_{IN} = \frac{I_{LOAD}}{f_s \times C1} \times \frac{V_{OUT}}{V_{IN}} \times \left(1 - \frac{V_{OUT}}{V_{IN}}\right)$$

### Selecting the Output Capacitor

The output capacitor (C2) is required to maintain the DC output voltage.

Low ESR ceramic capacitors can be used with MPM3820 to keep the output-ripple low. Generally, 22 $\mu$ F output ceramic capacitor is enough for most of the cases. In higher output voltage condition, 47 $\mu$ F might be needed for a stable system.

When using ceramic capacitors, the impedance at the switching frequency is dominated by the capacitance. The output-voltage ripple is mainly caused by the capacitance. For simplification, the output-voltage ripple is estimated by:

$$\Delta V_{OUT} = \frac{V_{OUT}}{8 \times f_s^2 \times L_1 \times C2} \times \left(1 - \frac{V_{OUT}}{V_{IN}}\right)$$

When using tantalum or electrolytic capacitors, the ESR dominates the impedance at the switching frequency. For simplification, the output ripple can be approximated by:

$$\Delta V_{OUT} = \frac{V_{OUT}}{f_s \times L_1} \times \left(1 - \frac{V_{OUT}}{V_{IN}}\right) \times R_{ESR}$$

The L1 is 1 $\mu$ H integrated inductor.

The characteristics of the output capacitor affect the stability of the regulation system.

### Layout Recommendation of MPM3820

Proper layout of the switching power supplies is very important, and sometimes critical to make it work properly. Especially, for the high switching converter, if the layout is not carefully done, the regulator could show poor line or load regulation, stability issues.

For MPM3820, the high speed step-down regulator, the input capacitor should be placed as close as possible to the IC pins. As shown in Figure 3, the 0805 size ceramic capacitor is used, please make sure the two ends of the ceramic capacitor be directly connected to PIN 12-14 (the Power Input Pin) and PIN 16 (the Power GND Pin). For additional device applications, please refer to related evaluation board datasheets (EVB).

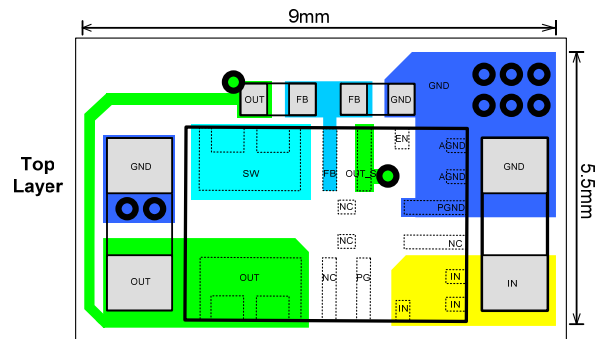

**Figure 3— Top Layer**

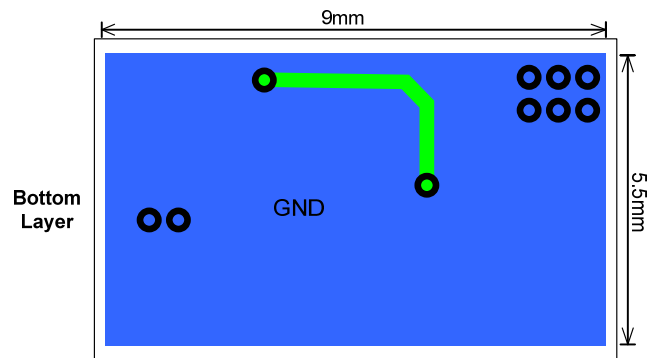

**Figure 4— Bottom Layer**



## TYPICAL APPLICATION CIRCUITS

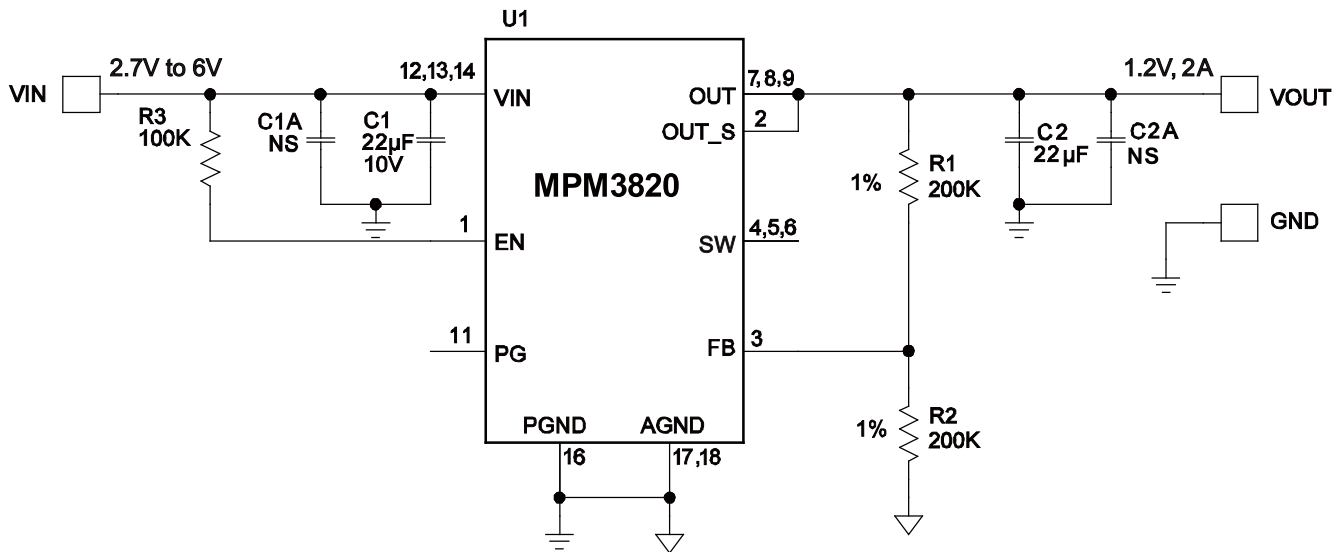

Figure 5— Typical Application Circuit

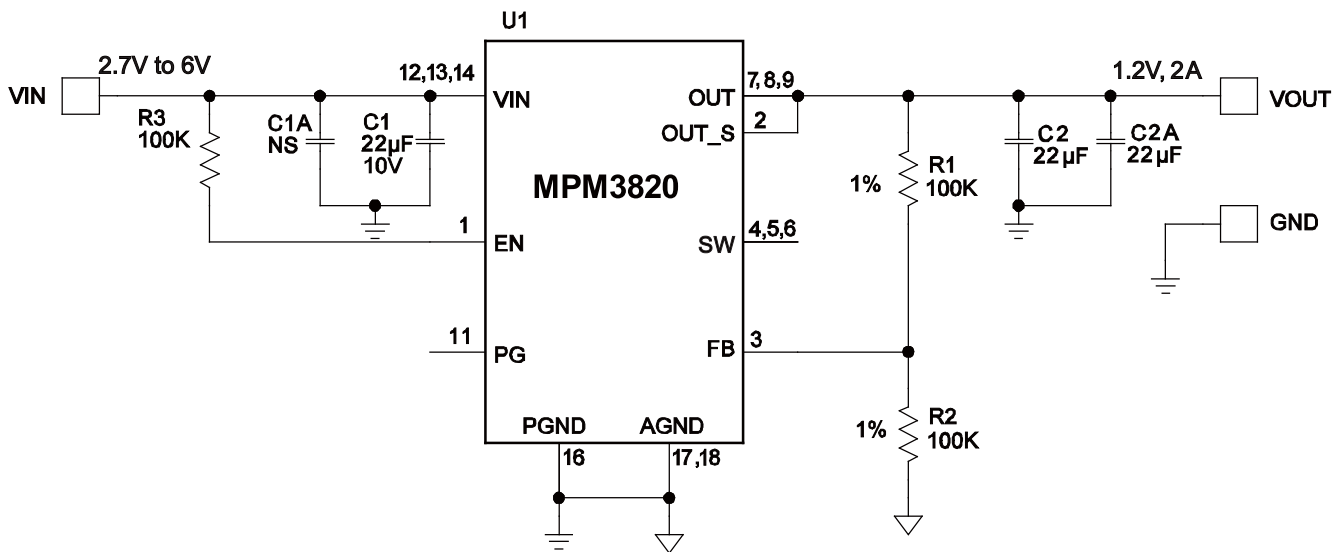
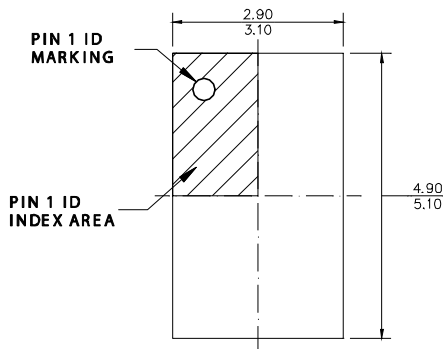

Figure 6— Better Load Regulation Circuit

## PACKAGE INFORMATION

### QFN-20 (3mmx5mm)



**TOP VIEW**

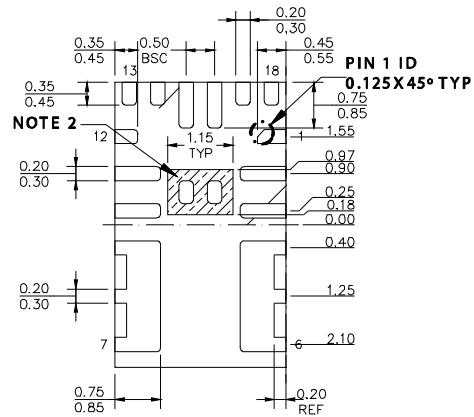

**BOTTOM VIEW**

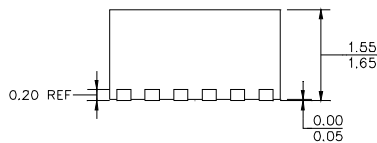

**SIDE VIEW**

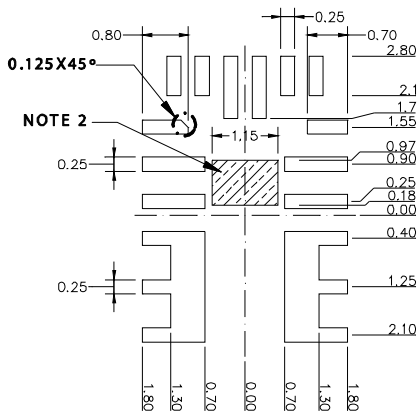

**RECOMMENDED LAND PATTERN**

**NOTE:**

- 1) ALL DIMENSIONS ARE IN MILLIMETERS.
- 2) SHADED AREA IS THE KEEP-OUT ZONE. THE EXPOSED BOTTOM METAL PADS ENCLOSED BY THIS ZONE IS NOT TO BE CONNECTED TO ANY PCB METAL TRACE & VIA ELECTRICALLY OR MECHANICALLY.
- 3) EXPOSED PADDLE SIZE DOES NOT INCLUDE MOLD FLASH.
- 4) LEAD COPLANARITY SHALL BE 0.10 MILLIMETERS MAX.
- 5) JEDEC REFERENCE IS MO-220.
- 6) DRAWING IS NOT TO SCALE.

**NOTICE:** The information in this document is subject to change without notice. Please contact MPS for current specifications. Users should warrant and guarantee that third party Intellectual Property rights are not infringed upon when integrating MPS products into any application. MPS will not assume any legal responsibility for any said applications.