

Hermetic Infrared Emitting Diode



OP123, OP124, OP223, OP224



Features:

- Hermetically sealed package
- Mechanically and spectrally matched to other OPTEK devices
- Designed for direct mount to PCBoard

Description:

Each **OP123** and **OP124** device is a 935 nanometer (nm) high intensity gallium arsenide infrared emitting diode (GaAs), mounted in a miniature hermetically sealed “pill” package with an enhanced temperature range and a high power output. These devices are designed for direct mounting to PCBoards.

Each **OP223** and **OP224** device is an 890 nm gallium aluminum arsenide infrared emitting diode (GaAlAs), mounted in a hermetically sealed “pill” package with an enhanced temperature range and a narrow irradiance pattern that provides high on-axis intensity for excellent coupling efficiency. These devices offer significantly higher power output than GaAs at equivalent drive currents and have a wavelength that is matched to silicon’s peak response. Their small package size permits high device density mounting.

All these LEDs are mechanically and spectrally matched to the OP300 series, OP600 series and OP640 series devices.

Please refer to Application Bulletins 208 and 210 for additional design information and reliability (degradation) data, and to Application Bulletin 202 for pill-type soldering to PCBoard.

Applications:

- Non-contact reflective object sensor
- Assembly line automation
- Machine automation
- Machine safety
- End of travel sensor
- Door sensor

Ordering Information		
Part Number	LED Peak Wavelength	Total Beam Angle
OP123	935 nm	24°
OP124		
OP223	890 nm	
OP224		

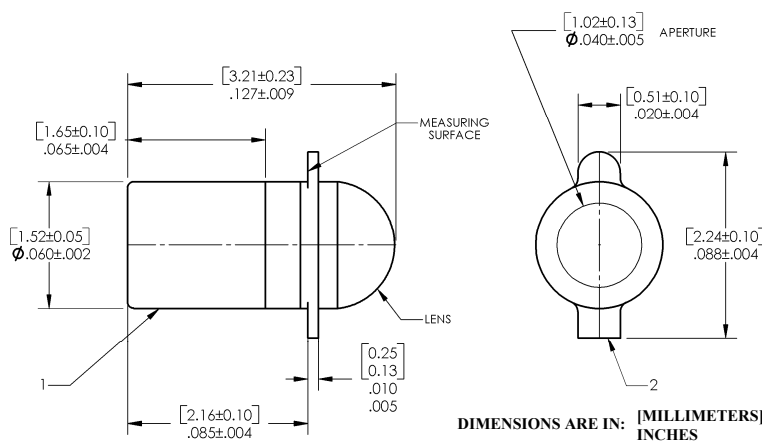

Pin #	LED	Sensor
1	Anode	Collector
2	Cathode	Emitter



RoHS

General Note
TT Electronics reserves the right to make changes in product specification without notice or liability. All information is subject to TT Electronics’ own data and is considered accurate at time of going to print.

OPTEK Technology, Inc.
1645 Wallace Drive, Carrollton, TX 75006 | Ph: +1 972 323 2200
www.optekinc.com | www.ttelectronics.com

Hermetic Infrared Emitting Diode



OP123, OP124, OP223, OP224

Electrical Specifications

Absolute Maximum Ratings ($T_A = 25^\circ\text{C}$ unless otherwise noted)	
Storage Temperature Range	-65°C to +150°C
Operating Temperature Range	-65°C to +125°C
Reverse Voltage	2.0 V
Continuous Forward Current	100 mA
Peak Forward Current (2μs pulse with 0.1% duty cycle)	1.0 A
Lead Soldering Temperature [1/16 inch (1.6 mm) from case for 5 seconds with soldering iron]	260°C ⁽¹⁾⁽²⁾
Power Dissipation	150 mW ⁽³⁾

Electrical Characteristics ($T_A = 25^\circ\text{C}$ unless otherwise noted)						
SYMBOL	PARAMETER	MIN	TYP	MAX	UNITS	TEST CONDITIONS
Input Diode						
$E_{E(APT)}^{(3)}$	Apertured Radiant Incidence					
	OP123	0.40	-	-	mW/cm ²	$I_F = 50\text{ mA}^{(4)}$
	OP124	1.00	-	-		
	OP223	1.00	-	-		
OP224	3.50	-	-			
V_F	Forward Voltage				V	$I_F = 50\text{ mA}$
	OP123	-	-	1.50		
	OP124	-	-	1.80		
I_R	Reverse Current	-	-	100	μA	$V_R = 2.0\text{ V}$
λ_P	Wavelength at Peak Emission				nm	$I_F = 50\text{ mA}$ $I_F = 10\text{ mA}$
	OP123, OP124	-	935	-		
	OP223, OP224	-	890	-		
B	Spectral Bandwidth between Half Power Points				nm	$I_F = 50\text{ mA}$ $I_F = 10\text{ mA}$
	OP123, OP124	-	50	-		
	OP223, OP224	-	80	-		
$\Delta\lambda_P/\Delta T$	Spectral Shift with Temperature				nm/°C	$I_F = \text{Constant}$
	OP123, OP124	-	+0.30	-		
	OP223, OP224	-	+0.18	-		
θ_{HP}	Emission Angle at Half Power Points	-	24	-	Degree	$I_F = 50\text{ mA}$
t_r	Output Rise Time				ns	$I_{F(PK)} = 100\text{ mA}$, PW=10 μs, and D.C.=10.0%
	OP123, OP124	-	1000	-		
	OP223, OP224	-	500	-		
t_f	Output Fall Time				ns	$I_{F(PK)} = 100\text{ mA}$, PW=10 μs, and D.C.=10.0%
	OP123, OP124	-	500	-		
	OP223, OP224	-	250	-		

Notes:

1. Refer to Application Bulletin 202 which reviews proper soldering techniques for pill-type devices.
2. No clean or low solids. RMA flux is recommended. Duration can be extended to 10 seconds maximum when flow soldering.
3. Derate linearly 1.50 mW/°C above 25°C.
4. For OP123, OP124, OP223 and OP224, $E_{E(APT)}$ is a measurement using a 0.031" (0.787 mm) diameter apertured sensor placed 0.50" (12.7 mm) from the measuring surface. $E_{E(APT)}$ is not necessarily uniform within the measured area.

General Note

TT Electronics reserves the right to make changes in product specification without notice or liability. All information is subject to TT Electronics' own data and is considered accurate at time of going to print.

OPTEK Technology, Inc.
1645 Wallace Drive, Carrollton, TX 75006 | Ph: +1 972 323 2200
www.optekinc.com | www.ttelectronics.com

Hermetic Infrared Emitting Diode



OP123, OP124, OP223, OP224

Performance

OP123, OP124

Forward Voltage vs Forward Current vs Temperature

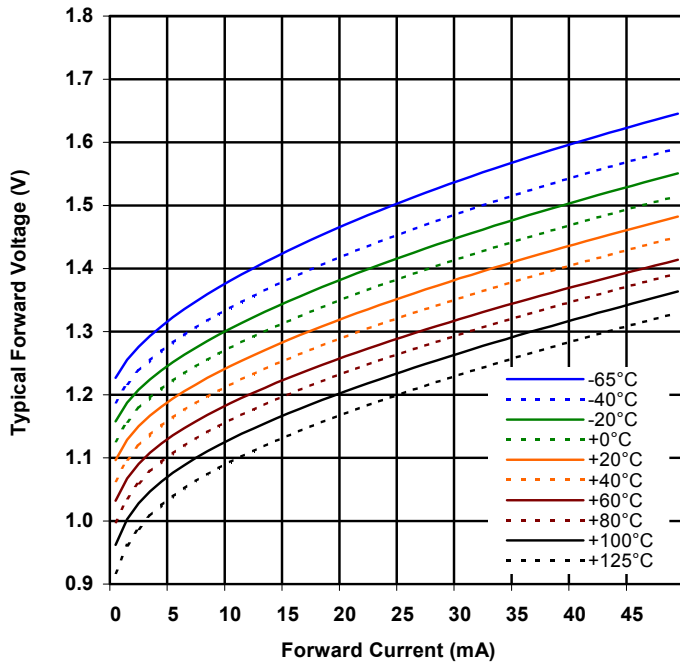

Optical Power vs I_F vs Temp

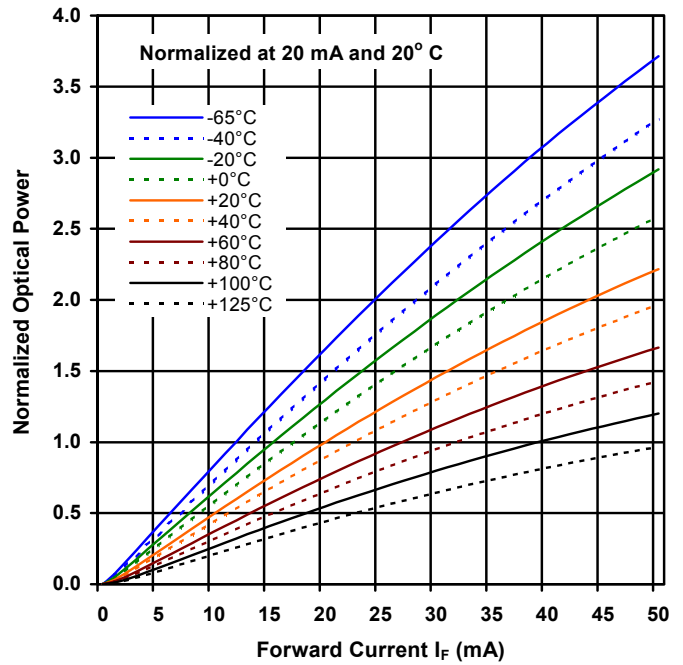

Distance vs Output Power vs Forward Current

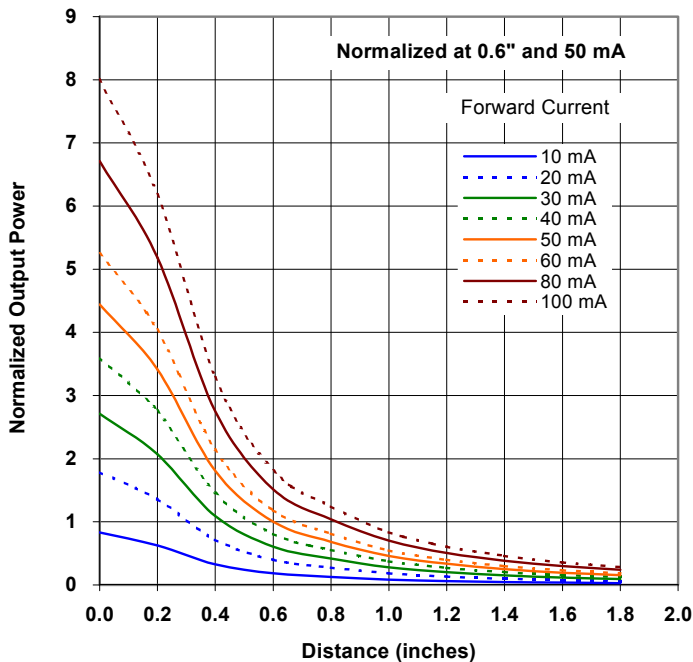

Normalized Intensity vs Beam Angle

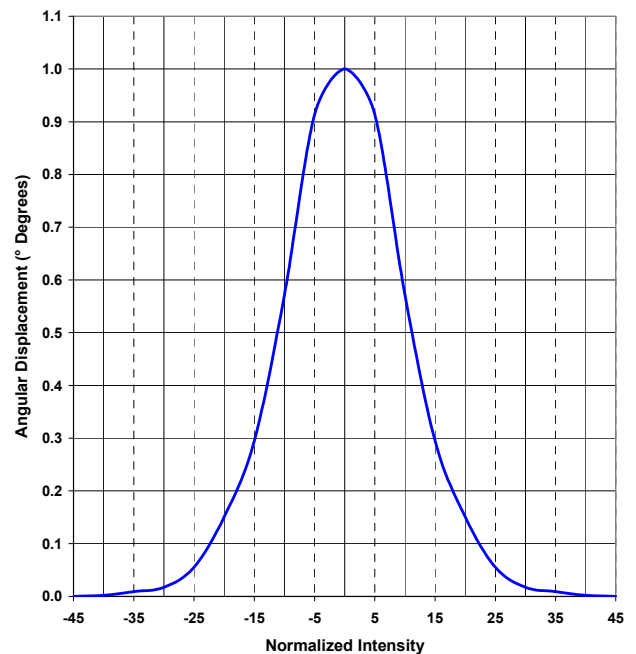

General Note
TT Electronics reserves the right to make changes in product specification without notice or liability. All information is subject to TT Electronics' own data and is considered accurate at time of going to print.

OPTEK Technology, Inc.
1645 Wallace Drive, Carrollton, TX 75006 | Ph: +1 972 323 2200
www.optekinc.com | www.ttelectronics.com

Hermetic Infrared Emitting Diode



OP123, OP124, OP223, OP224

Performance OP223, OP224

Forward Voltage vs Forward Current vs Temperature

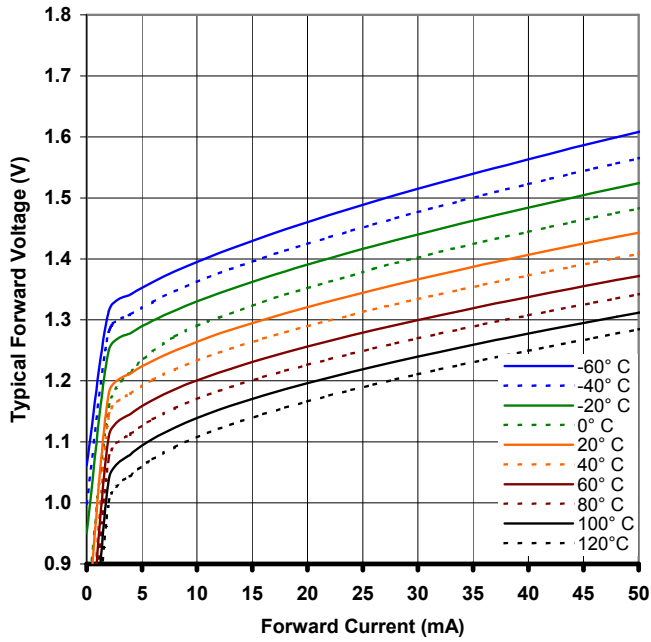

Optical Power vs I_F vs Temperature

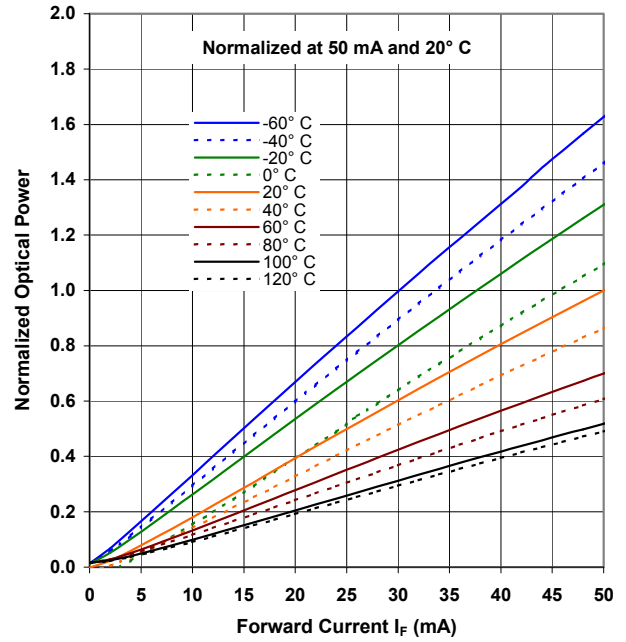

Distance vs Output Power vs Forward Current

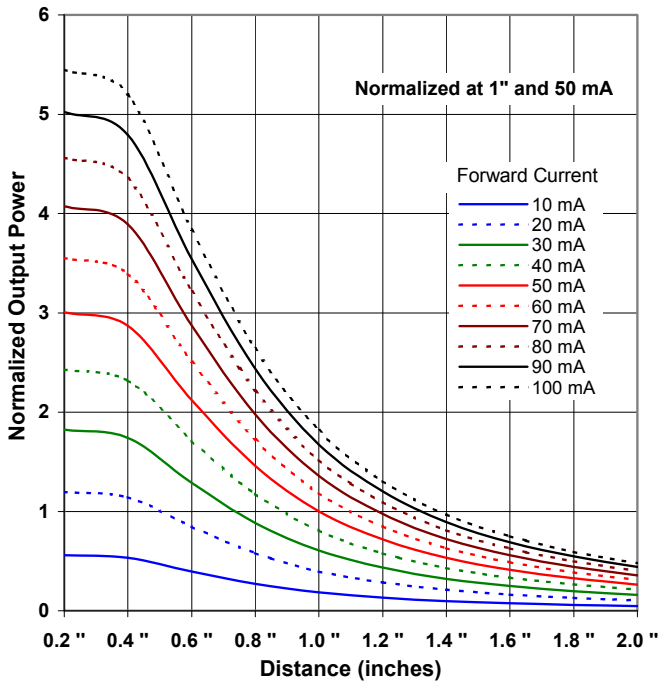

Normalized Intensity vs Beam Angle

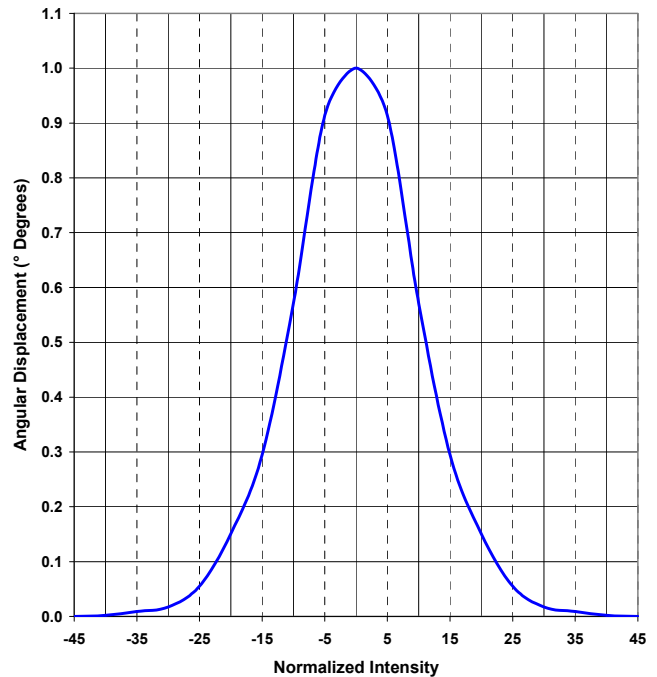

General Note
TT Electronics reserves the right to make changes in product specification without notice or liability. All information is subject to TT Electronics' own data and is considered accurate at time of going to print.

OPTEK Technology, Inc.
1645 Wallace Drive, Carrollton, TX 75006 | Ph: +1 972 323 2200
www.optekinc.com | www.ttelectronics.com