

Photoelectrics Retro-reflective, Polarized Type PD30CNP06....DU

CARLO GAVAZZI



- Miniature sensor range
- Range: 6 m, with reflector
- Sensitivity adjustment by Teach-In programming
- Modulated, red light 660 nm, polarized
- Supply voltage: 10 to 30 VDC
- Output: 100 mA, NPN or PNP preset
- Make and break switching function programmable
- LED indication for output, stability and power ON
- Protection: reverse polarity, short circuit and transients
- Cable and plug versions
- Excellent EMC performance
- Dust alarm output



Product Description

The PD30CNP06 sensor family comes in a compact 10 x 30 x 20 mm reinforced PMMA/ABS housing. The sensors are useful in applications where high-accuracy detection as well as small size is required. Compact housing and high power LED for excellent performance-size ratio.

The Teach-In function for adjustment of the sensitivity makes the sensors highly flexible. The output type is preset (NPN or PNP), and the output switching function is one programmable (NO or NC) and one dust output NO or NC.

Ordering Key

PD30CNP06PPM5DU

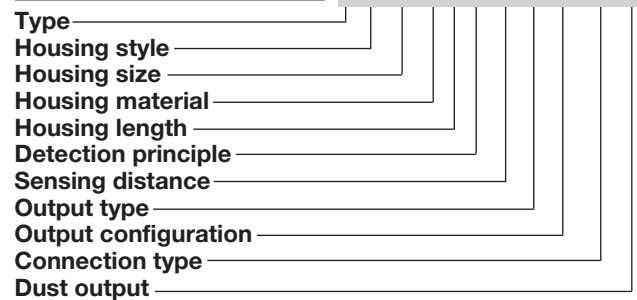

Type Selection

Housing W x H x D	Range S _n	Connection	Ordering no. NPN Make or break switching	Ordering no. PNP Make or break switching
10 x 30 x 20 mm	6 m	Cable	PD 30 CNP 06 NPDU	PD 30 CNP 06 PPDU
10 x 30 x 20 mm	6 m	Plug	PD 30 CNP 06 NPM5DU	PD 30 CNP 06 PPM5DU

Note: Reflectors to be ordered separately

Specifications EN 60947-5-2

Rated operating distance (S_n)	Up to 6 m, with reflector Ø 80 mm (ER4) 4 m on ER4060 reflector	Protection	Short-circuit, reverse polarity and transients
Blind zone	100 mm	Light source	GaAlAs, LED, 660 nm
Sensitivity	Adjustable by Teach-In	Light type	Red, modulated
Temperature drift	≤ 0.1%/°C	Sensing angle	± 2°
Hysteresis (H) (differential travel)	≤ 10%	Ambient light	10,000 lux
Rated operational volt. (U_B)	10 to 30 VDC (ripple included)	Light spot	110 mm @ 1.5 m
Ripple (U_{rpp})	≤ 10%	Operating frequency	1000 Hz
Output current Continuous (I _a) Short-time (I)	≤ 100 mA ≤ 100 mA (max. load capacity 100 nF)	Response time OFF-ON (t _{ON}) ON-OFF (t _{OFF})	≤ 0.5 ms ≤ 0.5 ms
Dust output current Continuous (I _a) Short-time (I)	≤ 20 mA ≤ 20 mA (max. load capacity 100 nF)	Power ON delay (t_v)	≤ 300 ms
No load supply current (I_o)	≤ 30 mA @ 24 VDC	Output function NPN and PNP NO/NC switching function	Preset Set by button
Minimum operational current (I_m)	0.5 mA	Output configuration Programming options Output pin 4 black Output	NO or NC NO or NC (dust)
OFF-state current (I_r)	≤ 100 µA	Dust alarm output Delay on operate	20 ms
Voltage drop (U_d)	≤ 2.4 VDC @ 100 mA	Indication Output ON Signal stability ON and power ON	LED, yellow LED, green

Specifications are subject to change without notice (12.07.2016)



Specifications (cont.) EN 60947-5-2

Environment		Rated insulation voltage	500 VAC (rms)
Installation category	III (IEC 60664/60664A; 60947-1)	Housing material	
Pollution degree	3 (IEC 60664/60664A; 60947-1)	Body	ABS
Degree of protection	IP 67 (IEC 60529; 60947-1)	Front material	PMMA, red
Ambient temperature		Connection	
Operating	-25° to +55°C (-13° to +131°F)	Cable	PVC, black, 2 m 4 x 0.14 mm ² , Ø = 3.3 mm
Storage	-40° to +70°C (-40° to +158°F)	Plug	M8, 4-pin (CON, 54-series)
Vibration	10 to 55 Hz, 0.5 mm/7.5 g (IEC 60068-2-6)	Weight	With cable: 40 g With plug: 10 g
Shock	30 g / 11ms, 3 pos, 3 neg per axis (IEC 60068-2-6, 60068-2-32)	CE-marking	Yes
		Approvals	cULus (UL508)

Operation Diagram

tv = Power ON delay

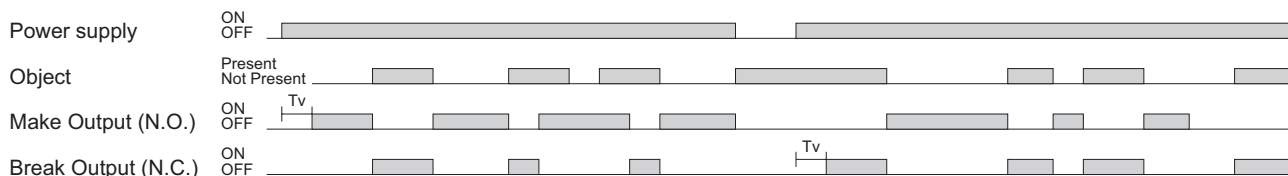

Wiring Diagrams

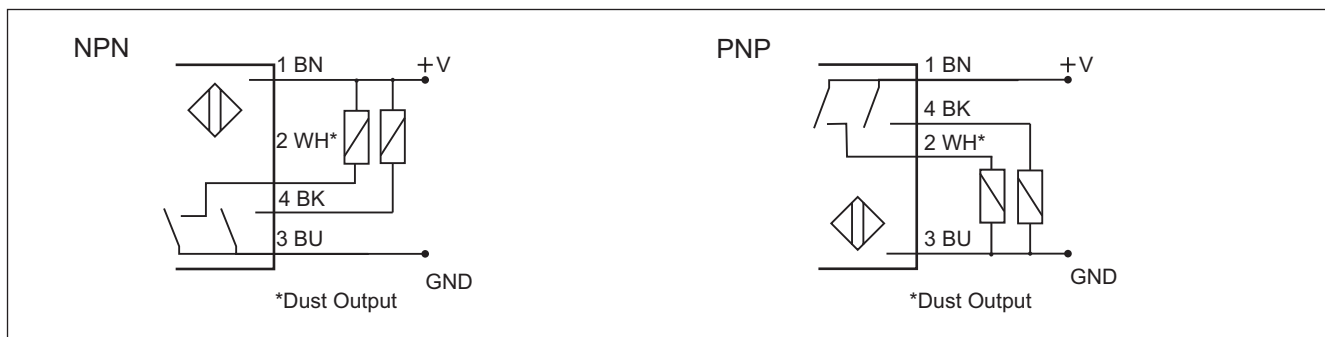

Detection Diagram

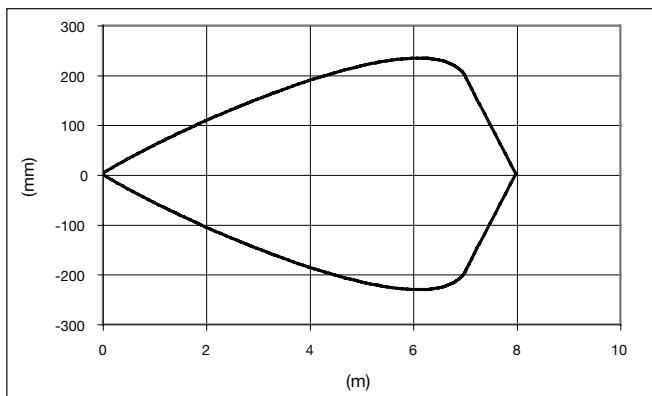

Excess Gain

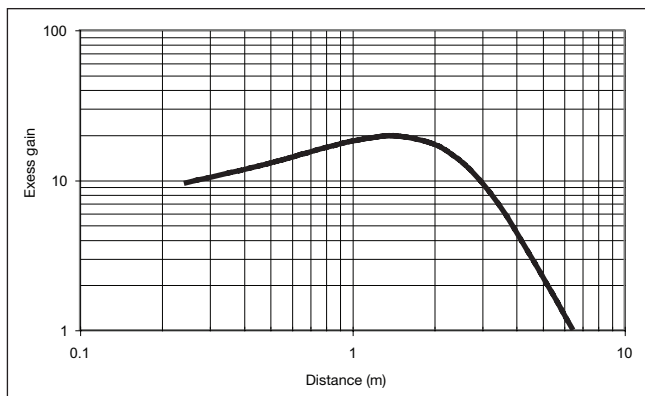

Signal Stability Indication

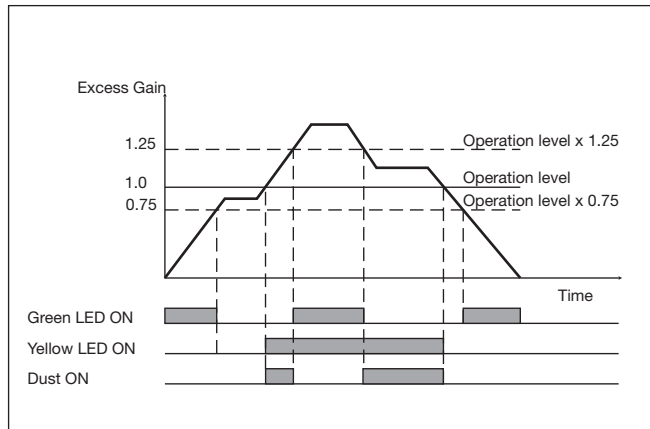

Accessories

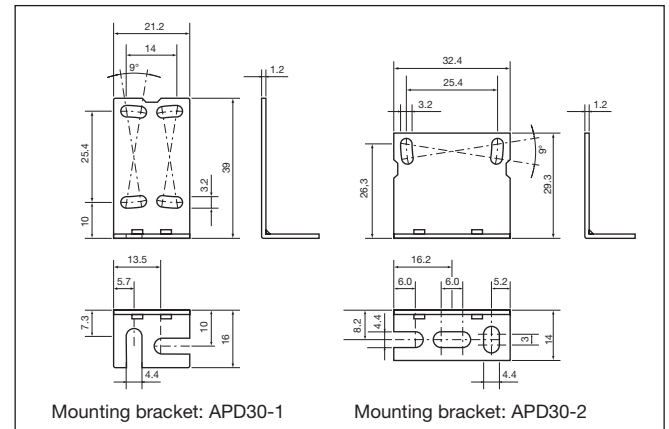

Dimensions

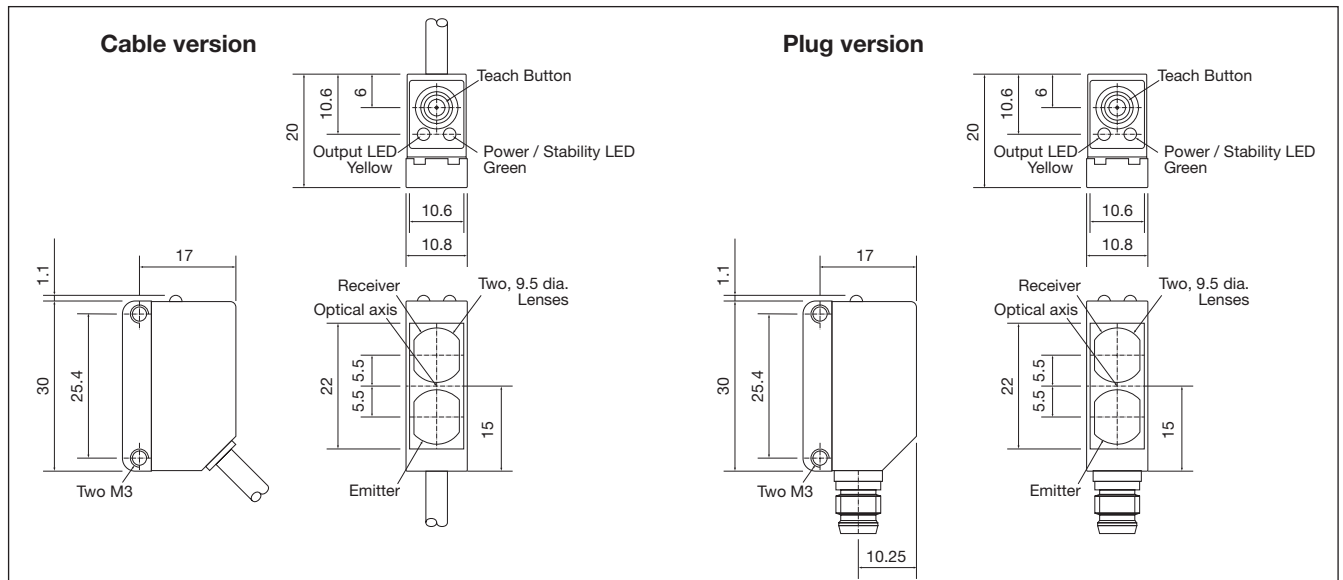

Installation Hints

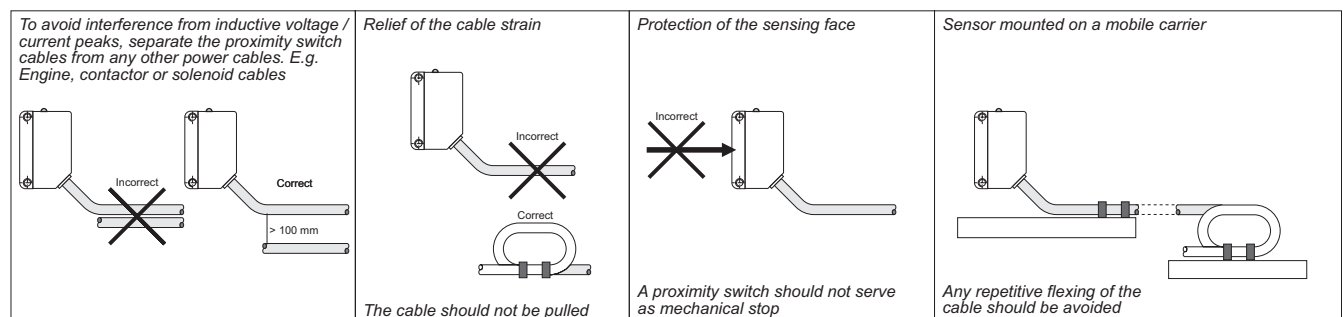

Delivery Contents

- Photoelectric switch: PD 30 CNP 06 ...
- Installation instruction
- Mountingbracket APD30-MB1
- **Packaging:** Cardboard box

Accessories

- Reflector is to be purchased separately
- Mounting bracket APD30-MB2 to be purchased separately

Teach functions

Normal operation, optimized switching point.

1. Line up the sensor with the reflector. Yellow LED and Green LED are ON.
2. Press the button for 3 seconds until both LEDs flashes simultaneously.
(The first switch point is stored)
3. Place the object between the sensor and reflector in the detection zone.
4. Press the button once and the sensor is ready to operate (Green LED ON, Yellow LED ON)
(The second switch point is stored)

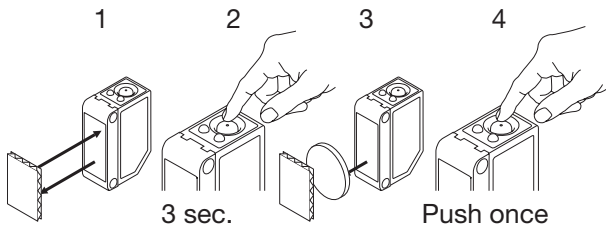

For dynamic set-up (running process)

1. Line up the sensor with the reflector. Green LED is ON, status on the yellow LED is not important.
2. Press the button for 3 second until both LEDs flashes simultaneously.
3. Press the button a second time for at least one second, both LED's flashes fast siultainiously and keep the button pressed for at least one process cycle, release the button and the sensor is ready to operate (The second switch point is stored)

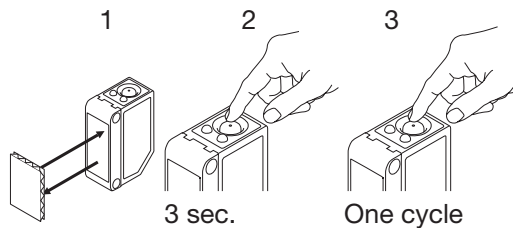

For maximum sensing distance (default setting)

1. Line up the sensor with the reflector, place the object between the sensor and reflector in the detection zone. Yellow LED is OFF and Green LED is ON.
2. Press the button for 3 seconds until both LEDs flashes simultaneously.
(The first switch point is stored)
3. Press the button a second time and the sensor is ready to operate (Green LED ON, Yellow LED ON)
(The second switch point is stored)

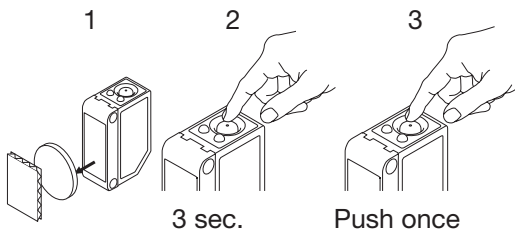

For make or break set-up (N.O. or N.C.)

1. Press the button for 10 seconds, until the green LEDs flashes.
2. While the green LED flashes, the output is inverted each time the button is pressed. Yellow LED indicates N.O. function selected.
If the button is not pressed within the next 10 seconds, the current output is stored.

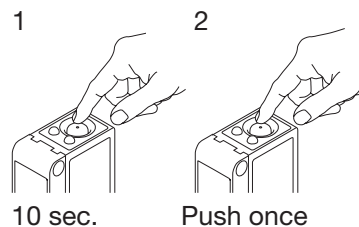

For dust output (N.O. or N.C.)

1. Press the button for 15 seconds, until the yellow LEDs flashes.
2. While the yellow LED flashes, the dust output is inverted each time the button is pressed. Green LED indicates N.O. function selected.
If the button is not pressed within the next 10 seconds, the current output is stored.

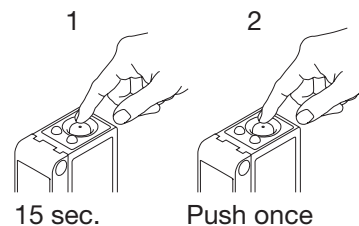

For minimum detection overhead.

1. Line up the sensor with the reflector. Yellow LED and Green LED are ON.
2. Press the button for 3 seconds until both LEDs flashes simultaneously.
(The first switch point is stored)
3. Press the button a second time and the sensor is ready to operate (Green LED ON, Yellow LED ON)
(The second switch point is stored)

