

# LT8570, LT8570-1 Boost/SEPIC/Inverting Regulator

## DESCRIPTION

Demonstration circuits 2297A-A and 2297A-B feature the [LT<sup>®</sup>8570](#) and LT8570-1 in a boost configuration. These demo circuits demonstrate small size and low component count. Both converters are designed to convert a 5V to 10V source to 12V. Refer to Figures 3 and 4 for maximum load current at different input voltage levels.

Both converters use only one feedback resistor to set the output voltage.

The LT8570 can operate with inputs as high as 40V but in these demo circuits, the input is limited by the voltage rating of the input capacitors, and the magnitude of the output voltage.

The LT8570 and LT8570-1 include many other features such as synchronization to external clock, user configurable undervoltage lockout, soft-start, frequency foldback, and other features that are easily configured as Boost, SEPIC or Inverting Converters.

The data sheet gives a complete description of the device, operation and application information. The data sheet must be read in conjunction with this demo manual for DC2297A.

**Design files for this circuit board are available at <http://www.linear.com/demo/DC2297A>**

LT, LT, LTC, LTM,  $\mu$ Module, Linear Technology and the Linear logo are registered trademarks of Linear Technology Corporation. All other trademarks are the property of their respective owners.

## PERFORMANCE SUMMARY Specifications are at $T_A = 25^\circ\text{C}$

SYMBOL	PARAMETER	CONDITIONS	MIN	TYP	MAX	UNITS
<b>DC2297A-A</b>						
$V_{IN}$	Input Supply Range		5		10	V
$V_{OUT}$	Output Voltage	$V_{IN} = 5\text{V}, I_{LOAD} = 125\text{mA}$	11.64	12	12.36	V
RIPPLE		$V_{IN} = 5\text{V}, I_{LOAD} = 125\text{mA}$		25		mV
EFFICIENCY		$V_{IN} = 5\text{V}, I_{LOAD} = 125\text{mA}$		86		%
SWITCHING FREQUENCY				1.5		MHz
<b>DC2297A-B</b>						
$V_{IN}$	Input Supply Range		5		10	V
$V_{OUT}$	Output Voltage	$V_{IN} = 5\text{V}, I_{LOAD} = 60\text{mA}$	11.64	12	12.36	V
RIPPLE		$V_{IN} = 5\text{V}, I_{LOAD} = 60\text{mA}$		5		mV
EFFICIENCY		$V_{IN} = 5\text{V}, I_{LOAD} = 60\text{mA}$		86		%
SWITCHING FREQUENCY				1.5		MHz

## QUICK START PROCEDURE

Demo circuit 2297A is easy to set up to evaluate the performance of the LT8570 and LT8570-1. Refer to Figure 1 for proper measurement equipment setup and follow the procedure below:

NOTE: When measuring the input or output voltage ripple, care must be taken to avoid a long ground lead on the oscilloscope probe. Measure the input or output voltage ripple by touching the probe tip directly across the VIN or VOUT and GND terminals. See Figure 2 for proper scope probe technique.

1. With power off, connect the input power supply to VIN and GND.

2. Turn on the power at the input.

NOTE: Make sure that the input voltage does not exceed 10V.

3. Check for the proper output voltage.

NOTE: If there is no output, temporarily disconnect the load to make sure that the load is not set too high.

4. Once the proper output voltages are established, adjust the load within the operating range and observe the output voltage regulation, ripple voltage, efficiency and other parameters.

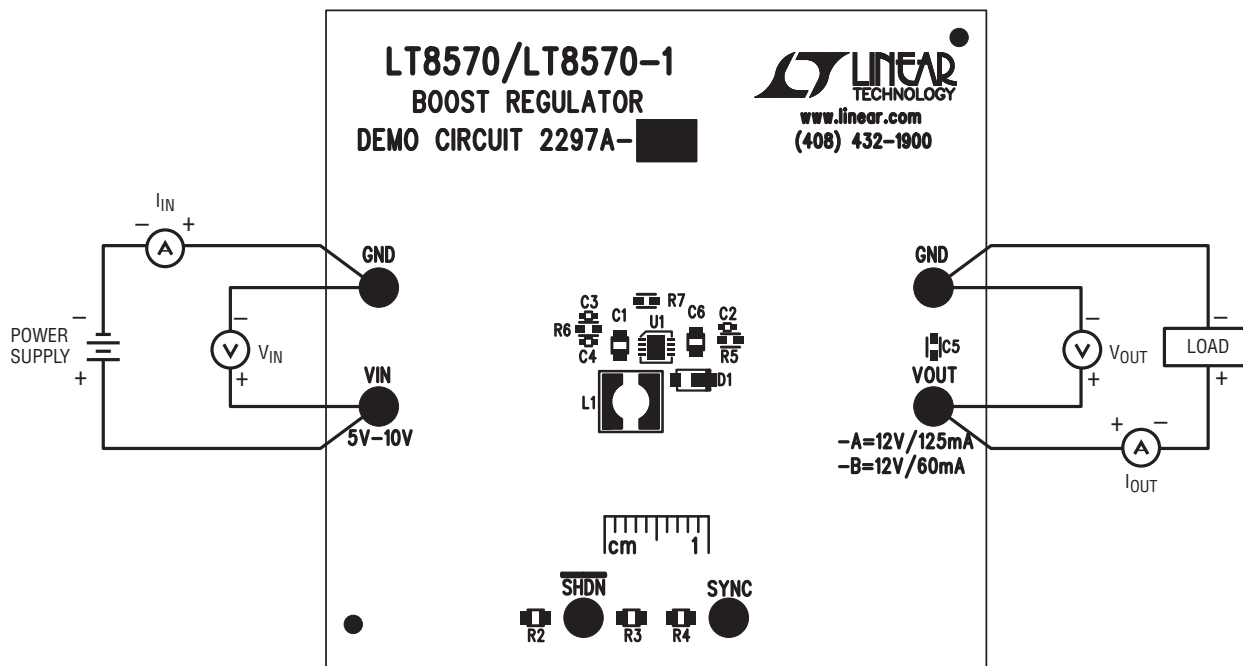

Figure 1. Proper Measurement Equipment Setup

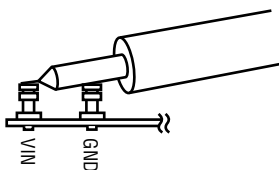

Figure 2. Measuring Input or Output Ripple

**QUICK START PROCEDURE**

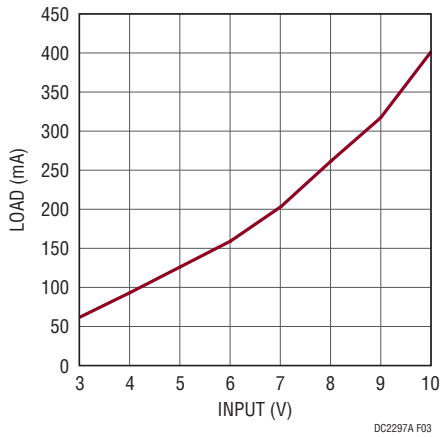

Figure 3. DC2297A-A Max Load Current vs Input Voltage

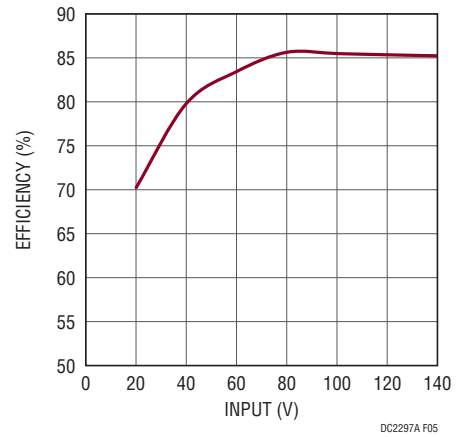

Figure 5. DC2297A-A Efficiency at 5V<sub>IN</sub>

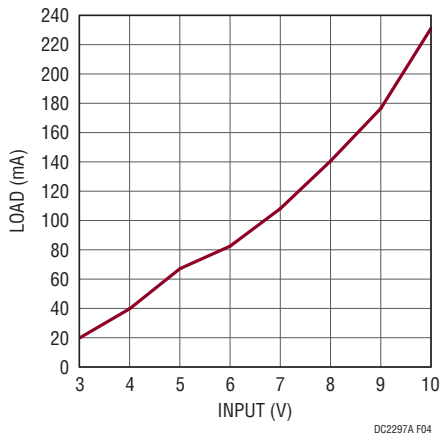

Figure 4. DC2297A-B Max Load Current vs Input Voltage

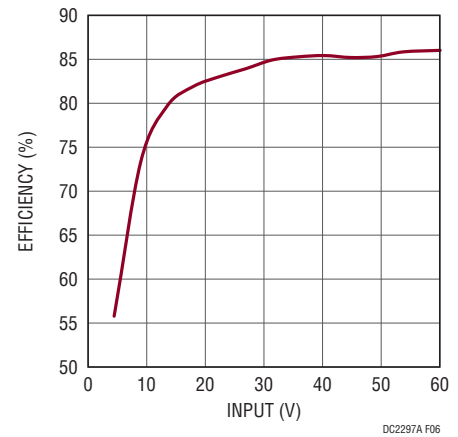

Figure 6. DC2297A-B Efficiency at 5V<sub>IN</sub>

# DEMO MANUAL DC2297A

## PARTS LIST

ITEM	QTY	REFERENCE	PART DESCRIPTION	MANUFACTURER/PART NUMBER
<b>DC2297A-A</b>				
<b>Required Circuit Components for Boost Regulator</b>				
1	1	C1	CAP., CER., 4.7µF, X7R, 16V, 10%, 0805	MURATA, GRM21BR71C475KA73L
2	1	C2	CAP., CER., 0.1µF, X7R, 16V, 10%, 0402	MURATA, GRM155R71C104KA88D
3	1	C3	CAP., CER., 2.2nF, X7R, 16V, 10%, 0402	AVX, 0402YC222KAT2A
4	1	C4	CAP., CER., 47pF, C0G, 25V, 5%, 0402	AVX, 04023A470JAT2A
5	1	C6	CAP., CER., 4.7µF, X7R, 16V, 10%, 0805	MURATA, GRM21BR71C475KA73L
6	1	D1	DIODE, SCHOTTKY, 30V, 1A, DI123	DIODES INC., DFLS130-7
7	1	L1	IND., 33µH	WÜRTH ELEKTRONIK, 744 042 330
8	1	R2	RES., 11.3k, 1/8W, 1%, 0805	VISHAY, CRCW080511K3FKEA
9	1	R3	RES., 10k, 1/8W, 1%, 0805	VISHAY, CRCW080510K0FKEA
10	1	R5	RES., 56.2k, 1/10W, 1%, 0603	VISHAY, CRCW060356K2FKEA
11	1	R6	RES., 6.04k, 1/10W, 1%, 0603	NIC, NRC06F6041TRF
12	1	R7	RES., 130k, 1/10W, 1%, 0603	VISHAY, CRCW0603130KFKEA
13	1	U1	I.C., LT8570EDD, 8DFN	LINEAR TECH., LT8570EDD#PBF
<b>Additional Demo Board Circuit Components</b>				
1	1	C5	CAP., CER., 0.1µF, X7R, 16V, 10%, 0603	TDK, C1608X7R1C104K
2	1	R4	RES., 100k, 1/8W, 1%, 0805	VISHAY, CRCW0805100KFKEA
<b>Hardware: For Demo Board Only</b>				
1	6	E1-E6	TEST POINT, TURRET, 0.094" MTG HOLE	MILL-MAX, 2501-2-00-80-00-00-07-0
<b>DC2297A-B</b>				
<b>Required Circuit Components for Boost Regulator</b>				
1	1	C1	CAP., CER., 4.7µF, X7R, 16V, 10%, 0805	MURATA, GRM21BR71C475KA73L
2	1	C2	CAP., CER., 0.1µF, X7R, 16V, 10%, 0402	MURATA, GRM155R71C104KA88D
3	1	C3	CAP., CER., 2.2nF, X7R, 16V, 10%, 0402	AVX, 0402YC222KAT2A
4	1	C4	CAP., CER., 47pF, C0G, 25V, 5%, 0402	AVX, 04023A470JAT2A
5	1	C6	CAP., CER., 2.2µF, X7R, 16V, 10%, 0805	MURATA, GRM21BR71C225KA12L
6	1	D1	DIODE, SCHOTTKY, 30V, 1A, DI123	DIODES INC., DFLS130-7
7	1	L1	IND., 68µH	U ELEKTRONIK, 744 042 680
8	1	R2	RES., 11.3k, 1/8W, 1%, 0805	VISHAY, CRCW080511K3FKEA
9	1	R3	RES., 10k, 1/8W, 1%, 0805	VISHAY, CRCW080510K0FKEA
10	1	R5	RES., 56.2k, 1/10W, 1%, 0603	VISHAY, CRCW060356K2FKEA
11	1	R6	RES., 6.04k, 1/10W, 1%, 0603	NIC, NRC06F6041TRF
12	1	R7	RES., 130k, 1/10W, 1%, 0603	VISHAY, CRCW0603130KFKEA
13	1	U1	I.C., LT8570EDD-1, 8DFN	LINEAR TECH., LT8570EDD-1#PBF
<b>Additional Demo Board Circuit Components</b>				
1	1	C5	CAP., CER., 0.1µF, X7R, 16V, 10%, 0603	TDK, C1608X7R1C104K
2	1	R4	RES., 100k, 1/8W, 1%, 0805	VISHAY, CRCW0805100KFKEA
<b>Hardware: For Demo Board Only</b>				
1	6	E-E6	TEST POINT, TURRET, 0.094" MTG HOLE	MILL-MAX, 2501-2-00-80-00-00-07-0

## SCHEMATIC DIAGRAM

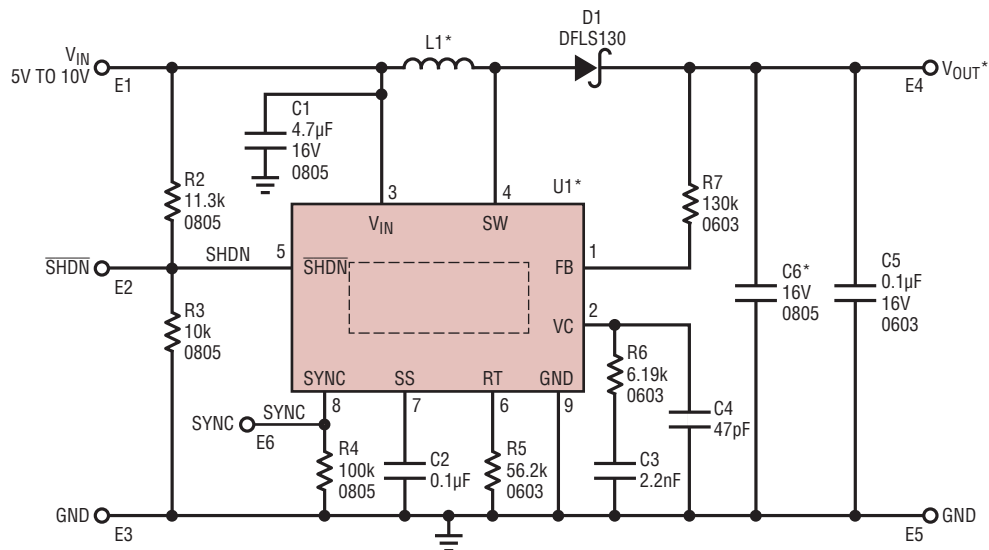

\* VERSION TABLE

ASSEMBLY TYPE	U1	C6	L1	V <sub>OUT</sub>
DC2297A-A	LT8570EDD	4.7µF	33µF	12V/125mA
DC2297A-B	LT8570-1EDD	2.2µF	66µH	12V/60mA

# DEMO MANUAL DC2297A

---

## DEMONSTRATION BOARD IMPORTANT NOTICE

Linear Technology Corporation (LTC) provides the enclosed product(s) under the following **AS IS** conditions:

This demonstration board (DEMO BOARD) kit being sold or provided by Linear Technology is intended for use for **ENGINEERING DEVELOPMENT OR EVALUATION PURPOSES ONLY** and is not provided by LTC for commercial use. As such, the DEMO BOARD herein may not be complete in terms of required design-, marketing-, and/or manufacturing-related protective considerations, including but not limited to product safety measures typically found in finished commercial goods. As a prototype, this product does not fall within the scope of the European Union directive on electromagnetic compatibility and therefore may or may not meet the technical requirements of the directive, or other regulations.

If this evaluation kit does not meet the specifications recited in the DEMO BOARD manual the kit may be returned within 30 days from the date of delivery for a full refund. **THE FOREGOING WARRANTY IS THE EXCLUSIVE WARRANTY MADE BY THE SELLER TO BUYER AND IS IN LIEU OF ALL OTHER WARRANTIES, EXPRESSED, IMPLIED, OR STATUTORY, INCLUDING ANY WARRANTY OF MERCHANTABILITY OR FITNESS FOR ANY PARTICULAR PURPOSE. EXCEPT TO THE EXTENT OF THIS INDEMNITY, NEITHER PARTY SHALL BE LIABLE TO THE OTHER FOR ANY INDIRECT, SPECIAL, INCIDENTAL, OR CONSEQUENTIAL DAMAGES.**

The user assumes all responsibility and liability for proper and safe handling of the goods. Further, the user releases LTC from all claims arising from the handling or use of the goods. Due to the open construction of the product, it is the user's responsibility to take any and all appropriate precautions with regard to electrostatic discharge. Also be aware that the products herein may not be regulatory compliant or agency certified (FCC, UL, CE, etc.).

No License is granted under any patent right or other intellectual property whatsoever. **LTC assumes no liability for applications assistance, customer product design, software performance, or infringement of patents or any other intellectual property rights of any kind.**

LTC currently services a variety of customers for products around the world, and therefore this transaction **is not exclusive**.

**Please read the DEMO BOARD manual prior to handling the product.** Persons handling this product must have electronics training and observe good laboratory practice standards. **Common sense is encouraged.**

This notice contains important safety information about temperatures and voltages. For further safety concerns, please contact a LTC application engineer.

Mailing Address:

Linear Technology  
1630 McCarthy Blvd.  
Milpitas, CA 95035

Copyright © 2004, Linear Technology Corporation