

## 8-Channel High-Speed $\pm 60\text{V}$ $\pm 1\text{A}$ Ultrasound RTZ Pulser

### Features

- HVCMOS<sup>®</sup> Technology for High Performance
- High-density Integrated Ultrasound Transmitter
- 0V to  $\pm 60\text{V}$  Output Voltage
- $\pm 1\text{A}$  Source and Sink Current in Pulse Mode
- $\pm 1\text{A}$  Source and Sink Current in Return-to-Zero (RTZ) Mode
- Up to 20 MHz Operating Frequency
- Matched Delay Times
- Optional Clock Realignment
- 3.3V CMOS Logic Interface and Reference
- +3.3V Low-voltage Supply for  $V_{DD}$
- Built-in Linear Regulators for Floating Gate Drivers
- Built-in Output Drain Diodes and Bleed Resistors

### Applications

- Portable Medical Ultrasound Imaging
- Piezoelectric Transducer Drivers
- Pulse Waveform Generator

### General Description

The HV7350 is an 8-channel monolithic high-voltage high-speed pulse generator with built-in fast return to zero-damping FETs. This high-voltage and high-speed integrated circuit is designed for portable medical ultrasound imaging system.

The HV7350 consists of a controller logic interface circuit, level translators, MOSFET gate drives, and high-current power P-channel and N-channel MOSFETs as the output stage for each channel.

The output peak currents of each channel are guaranteed to be over  $\pm 1\text{A}$  with up to  $\pm 60\text{V}$  pulse swings as well as Return-to-Zero mode. The gate drivers for the output MOSFETs are powered by built-in linear 5V regulators referenced to  $V_{PP}$  and  $V_{NN}$ . This direct coupling topology of the gate drivers not only saves four floating voltage supplies or AC coupling capacitors per channel but also makes the PCB layout smaller and easier.

An input clock pin is available to realign all the logic input control lines to a master clock. Precise logic timing is always essential in any ultrasound systems.

### Package Type

**56-lead (8 X 8) QFN**  
(Top view)

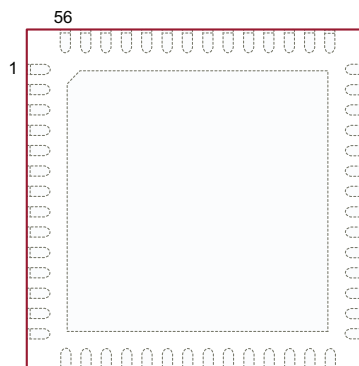

See [Table 2-1](#) for pin information.

# HV7350

## Typical Application Circuit

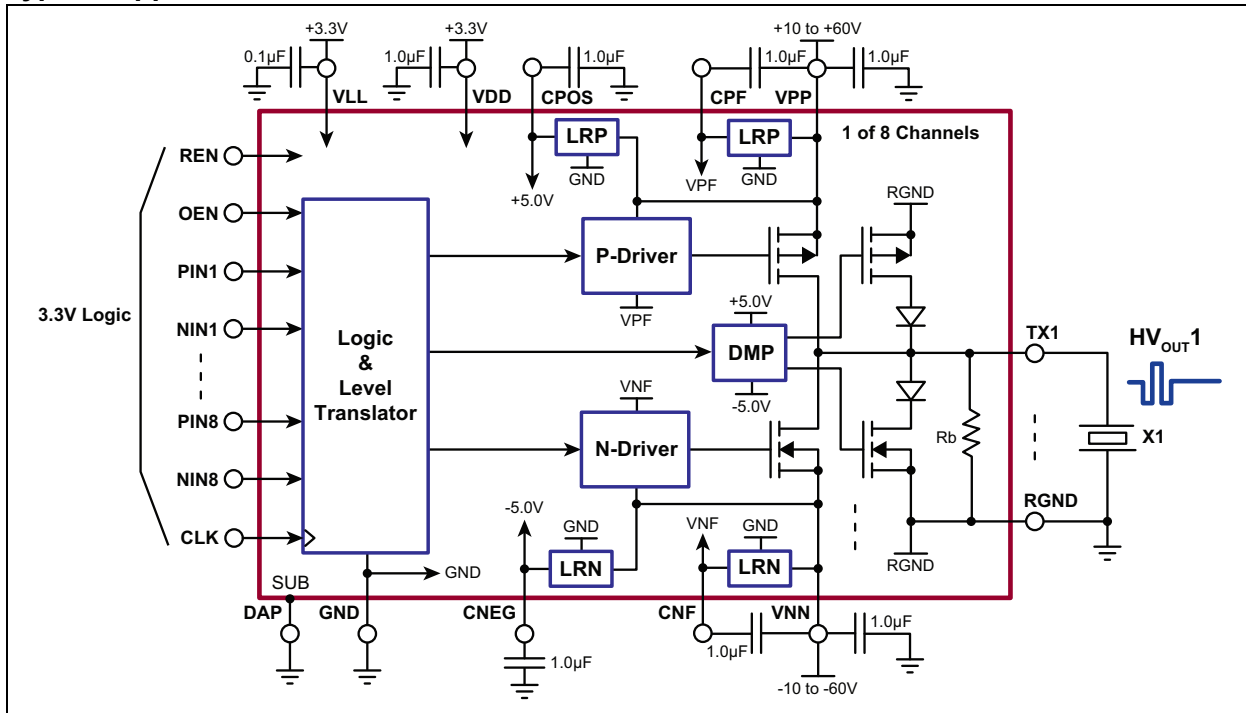

## 1.0 ELECTRICAL CHARACTERISTICS

### Absolute Maximum Ratings †

GND and Substrate Voltage, V <sub>SUB</sub> .....	0V
Positive Logic Supply, V <sub>LL</sub> .....	-0.5V to +5.5V
Positive Logic and Level Translator Supply, V <sub>DD</sub> .....	-0.5V to +5.5V
Positive Level Translator Decoupling Pin, C <sub>POS</sub> to GND .....	-0.5V to +5.5V
Negative Level Translator Decoupling Pin, C <sub>NEG</sub> to GND .....	+0.5V to -5.5V
Positive Floating Gate Driver Decoupling Pin, V <sub>PP</sub> -C <sub>PF</sub> .....	-0.5V to +5.5V
Floating Gate Driver Decoupling Pin, C <sub>NF</sub> -V <sub>NN</sub> .....	-0.5V to +5.5V
Differential High-voltage Supply, V <sub>PP</sub> -V <sub>NN</sub> .....	+130V
High-voltage Positive Supply, V <sub>PP</sub> .....	-0.5V to +65V
High-voltage Negative Supply, V <sub>NN</sub> .....	+0.5V to -65V
All Logic Input CLK, PIN <sub>X</sub> , NIN <sub>X</sub> , OEN and REN Voltages .....	-0.5V to +5.5V
Operating Junction Temperature, T <sub>J</sub> .....	-40°C to +125°C
Storage Temperature, T <sub>S</sub> .....	-65°C to +150°C
ESD Rating ( <b>Note 1</b> ).....	ESD Sensitive

† **Note:** Stresses above those listed under “Absolute Maximum Ratings” may cause permanent damage to the device. This is a stress rating only, and functional operation of the device at those or any other conditions above those indicated in the operational sections of this specification is not intended. Exposure to maximum rating conditions for extended periods may affect device reliability.

**Note 1:** Devices are ESD sensitive. Handling precautions are recommended.

### OPERATING SUPPLY VOLTAGES AND CURRENT (EIGHT ACTIVE CHANNELS)

**Electrical Specifications:** V<sub>LL</sub> = +3.3V, V<sub>DD</sub> = +3.3V, V<sub>PP</sub> = +60V, V<sub>NN</sub> = -60V, V<sub>CLK</sub> = +3.3V, T<sub>A</sub> = 25°C unless otherwise indicated.

Parameter	Sym.	Min.	Typ.	Max.	Unit	Conditions
V <sub>DD</sub> Voltage Supply	V <sub>DD</sub>	2.97	3.3	5.2	V	
V <sub>DD</sub> UVLO	UVLO <sub>DD</sub>	2.3	2.6	2.8	V	
Logic Voltage Reference	V <sub>LL</sub>	2.5	3.3	5	V	
V <sub>LL</sub> UVLO	UVLO <sub>LL</sub>	1.3	1.55	1.7	V	
Positive High-voltage Supply	V <sub>PP</sub>	+10	—	+60	V	
Negative High-voltage Supply	V <sub>NN</sub>	-60	—	-10	V	
V <sub>LL</sub> Current	I <sub>LLQ</sub>	—	8	—	μA	OEN = REN = 0
V <sub>DD</sub> Current	I <sub>DDQ</sub>	—	1	—		
V <sub>PP</sub> Current	I <sub>PPQ</sub>	—	5	10		
V <sub>NN</sub> Current	I <sub>NNQ</sub>	—	5	10		
V <sub>LL</sub> Current	I <sub>LLEN</sub>	—	13	20	μA	OEN = REN = 1 5 ms after f = 0 MHz
V <sub>DD</sub> Current	I <sub>DDEN</sub>	—	480	700		
V <sub>PP</sub> Current	I <sub>PPEN</sub>	—	220	350		
V <sub>NN</sub> Current	I <sub>NNEN</sub>	—	300	400	mA	f = 5 MHz, continuous, no loads, for calculation reference only
V <sub>DD</sub> Current	I <sub>DCCW</sub>	—	2.3	—		
V <sub>PP</sub> Current	I <sub>PPCW</sub>	—	80	—		
V <sub>NN</sub> Current	I <sub>NNCW</sub>	—	80	—	μA	f <sub>CLK</sub> = 10 MHz, PIN = NIN = 0
VLL Current	I <sub>LL,CLK</sub>	—	33	—		

# HV7350

## DC ELECTRICAL CHARACTERISTICS

Electrical Specifications: $V_{LL} = +3.3V$ , $V_{DD} = +3.3V$ , $V_{PP} = +60V$ , $V_{NN} = -60V$ , $V_{CLK} = +3.3V$ , $T_A = 25^\circ C$ unless otherwise indicated.						
Parameter	Sym.	Min.	Typ.	Max.	Unit	Conditions
<b>PULSER P-CHANNEL MOSFET</b>						
Output Saturation Current	$I_{OUT}$	1	1.5	—	A	
Channel Resistance	$R_{ON}$	—	13.2	—	$\Omega$	$I_{SD} = 100\text{ mA}$
<b>PULSER P-CHANNEL MOSFET</b>						
Output Saturation Current	$I_{OUT}$	1	1.5	—	A	
Channel Resistance	$R_{ON}$	—	8	—	$\Omega$	$I_{SD} = 100\text{ mA}$
<b>DAMPING P-CHANNEL MOSFET</b>						
Output Saturation Current	$I_{OUT}$	1	1.5	—	A	
Channel Resistance	$R_{ON}$	—	13	—	$\Omega$	$I_{SD} = 100\text{ mA}$
<b>DAMPING N-CHANNEL MOSFET</b>						
Output Saturation Current	$I_{OUT}$	1	1.5	—	A	
Channel Resistance	$R_{ON}$	—	9	—	$\Omega$	$I_{SD} = 100\text{ mA}$
<b>LOGIC INPUT</b>						
Input Logic High Voltage	$V_{IH}$	$0.7 \cdot V_{LL}$	—	$V_{LL}$	V	$V_{LL} = 2.5V$ to $3.3V$ $V_{LL} = 5V$
		$0.8 \cdot V_{LL}$	—			
Input Logic Low Voltage	$V_{IL}$	0	—	$0.3 \cdot V_{LL}$	V	$V_{LL} = 2.5V$ to $3.3V$ $V_{LL} = 5V$
			—	$0.2 \cdot V_{LL}$		
Input Logic High Current	$I_{IH}$	—	—	10	$\mu A$	
Input Logic Low Current	$I_{IL}$	-10	—	—	$\mu A$	
Input Logic Capacitance	$C_{IN}$	—	—	5	pF	
<b>MOSFET DRAIN BLEED RESISTOR</b>						
Output Bleed Resistance	$R_{B1-8}$	12	17	25	k $\Omega$	
Bleed Resistors Power Limit	$P_{RB1-8}$	—	—	50	mW	

## AC ELECTRICAL CHARACTERISTICS

Electrical Specifications: $V_{LL} = +3.3V$ , $V_{DD} = +3.3V$ , $V_{PP} = +60V$ , $V_{NN} = -60V$ , $V_{CLK} = +3.3V$ , $T_A = 25^\circ C$ unless otherwise indicated.						
Parameter	Sym.	Min.	Typ.	Max.	Unit	Conditions
Output Rise Time	$t_r$	—	30	—	ns	330 pF//2.5 k $\Omega$ load
Output Fall Time	$t_f$	—	30	—	ns	10%–90%
Enable Time	$t_{EN}$	—	300	500	$\mu s$	Cap value (See <a href="#">Typical Application Circuit.</a> ), OEN = REN
Disable Time	$t_{DIS}$	—	2.8	10	$\mu s$	
Delay Time on PIN <sub>x</sub> Rise	$t_{d1}$	—	12	—	ns	1 $\Omega$ resistor load, D% < 1% (See <a href="#">Timing Waveforms.</a> ) 50% inputs to 50% $T_X$ current
Delay Time on NIN <sub>x</sub> Rise	$t_{d2}$	—	12	—		
Delay Time on Damping Rise	$t_{d3}$	—	12	—		
Delay Time on Damping Fall	$t_{d4}$	—	12	—		
Delay Time on CLK Rise	$t_{dc}$	—	9	—		
Delay Time Matching	$\Delta t_{DELAY}$	—	$\pm 3$	—	ns	P to N, channel to channel
Delay Jitter on Rise or Fall	$t_j$	—	30	—	ps	$V_{PP}/V_{NN} = +/-25V$ , input $t_r$ 50% to HV <sub>OUT</sub> $t_r$ or $t_f$ 50%, with 330 pF//2.5 k $\Omega$ load
RTZ FETs Drain Diode $t_{rr}$	$t_{rr}$	—	25	—	ns	$I_F = 1A$ , $I_R = 1A$ , $R_L = 10\Omega$

## AC ELECTRICAL CHARACTERISTICS (CONTINUED)





**Electrical Specifications:**  $V_{LL} = +3.3V$ ,  $V_{DD} = +3.3V$ ,  $V_{PP} = +60V$ ,  $V_{NN} = -60V$ ,  $V_{CLK} = +3.3V$ ,  $T_A = 25^\circ C$  unless otherwise indicated.

Parameter	Sym.	Min.	Typ.	Max.	Unit	Conditions
Retiming Clock Frequency	$f_{CLK}$	10	220	—	MHz	
Retiming Clock Rise and Fall Times	$t_{rc}$ , $t_{fc}$	—	0.5	5	ns	
Set-up Time, PIN/NIN to CLK	$t_{SU}$	2	—	—	ns	
Hold time, CLK to PIN/NIN	$t_H$	1	—	—	ns	
Clock Time Low	$t_{CLK\_LO}$	2	—	100	ns	CLK input must have at least one pulse before PIN and NIN inputs are not zero. Be sure to return inputs to zero before stopping clock.
Clock Time High	$t_{CLK\_HI}$	2	—	100	ns	
Clock Recognition Time	$t_{CLK\_REC}$	—	2	—	ns	
Clock Release Time	$t_{CLK\_RLS}$	150	300	800	ns	
Output Frequency Range	$f_{OUT}$	—	—	20	MHz	100 $\Omega$ resistor load
Second Harmonic Distortion	HD2	—	-40	—	dB	
Output Capacitance	$C_{OSS}$	—	50	—	pF	$V_{DS} = 25V$ , $f = 1$ MHz of $T_X$ pin total

## TEMPERATURE SPECIFICATIONS

Parameter	Sym.	Min.	Typ.	Max.	Unit	Conditions
<b>TEMPERATURE RANGE</b>						
Operating Junction Temperature	$T_J$	-40	—	+125	$^\circ C$	
Storage Temperature	$T_S$	-65	—	+150	$^\circ C$	
<b>PACKAGE THERMAL RESISTANCE</b>						
56-lead (8 X 8) QFN	$\theta_{JA}$	—	21	—	$^\circ C/W$	

## LOGIC CONTROL TABLE

MODE	LOGIC INPUTS				$TX_N$ OUTPUT		
	OEN	CLK	$PIN_X$	NINX	VPP	VNN	RGND
Asynchronous Mode Output Change on PIN/NIN	1	VLL	0	0	OFF	OFF	ON
	1	VLL	1	0	ON	OFF	OFF
	1	VLL	0	1	OFF	ON	OFF
	1	VLL	1	1	OFF	OFF	OFF
Synchronous Mode Output Change at Retim- ing Clock (CLK) Rising Edge, registered by PIN/NIN	1		0	0	OFF	OFF	ON
	1		1	0	ON	OFF	OFF
	1		0	1	OFF	ON	OFF
	1		1	1	OFF	OFF	OFF
Disabled	0	X	X	X	OFF	OFF	OFF

# HV7350

## Timing Waveforms

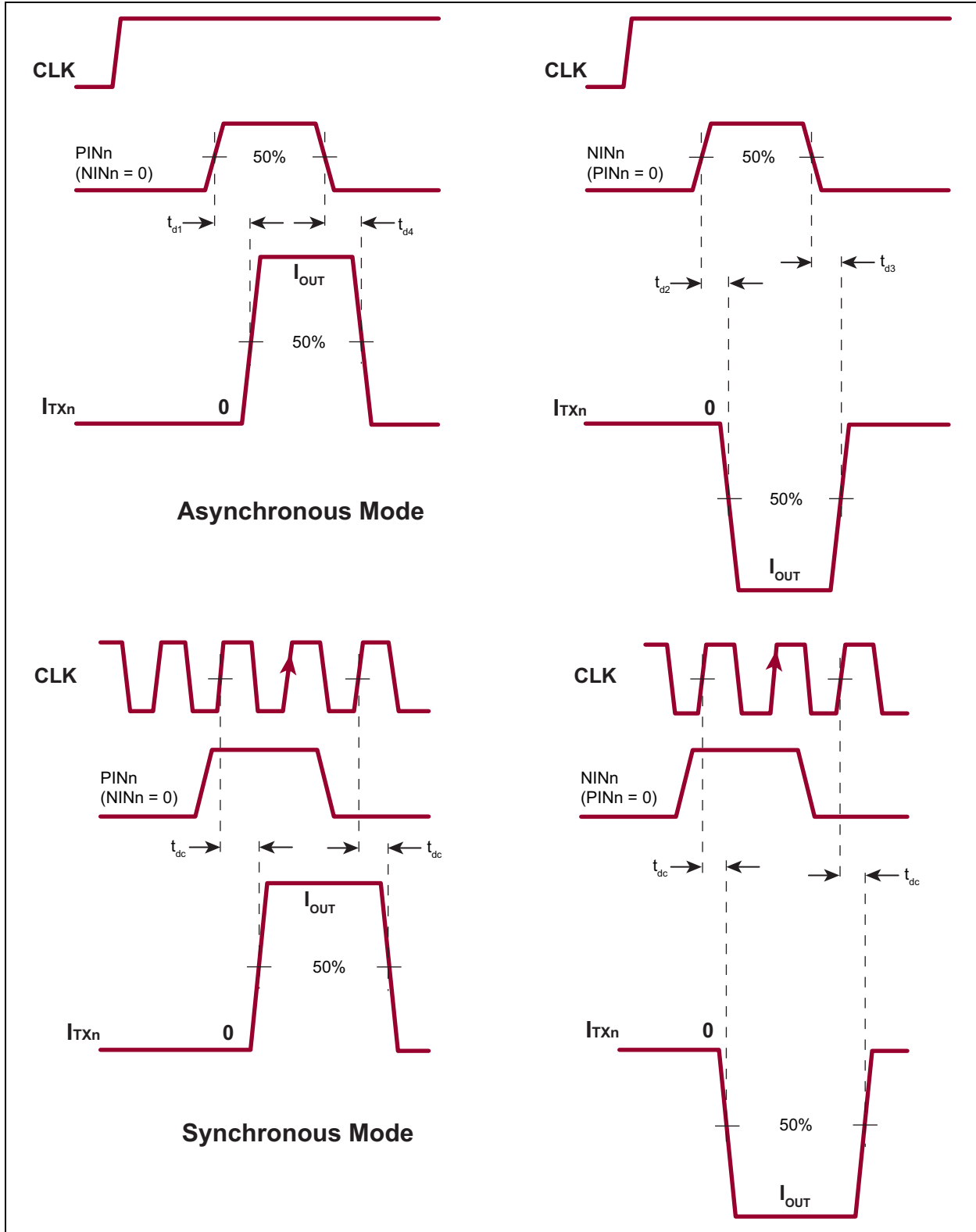

## 2.0 PAD DESCRIPTION

Table 2-1 details the description of pads in HV7350.

Refer to [Package Type](#) for the location of pins.

**TABLE 2-1: PAD FUNCTION TABLE**

Pin Number	Pin Name	Description
1	PIN2	Input logic control of high-voltage output P-FET for Channel 2; High = on; Low = off (See <a href="#">Logic Control Table</a> .)
2	NIN2	Input logic control of high-voltage output N-FET for Channel 2; High = on; Low = off (See <a href="#">Logic Control Table</a> .)
3	PIN3	Input logic control of high-voltage output P-FET for Channel 3; High = on; Low = off (See <a href="#">Logic Control Table</a> .)
4	NIN3	Input logic control of high-voltage output N-FET for Channel 3; High = on; Low = off (See <a href="#">Logic Control Table</a> .)
5	PIN4	Input logic control of high-voltage output P-FET for Channel 4; High = on; Low = off (See <a href="#">Logic Control Table</a> .)
6	NIN4	Input logic control of high-voltage output N-FET for Channel 4; High = on; Low = off (See <a href="#">Logic Control Table</a> .)
7	OEN	Output enable; High = on; Low = off (See <a href="#">Logic Control Table</a> .)
8	REN	Built-in positive and negative 5V voltage regulators enable; High = on; Low = off If REN = 0, four isolated 5V power supplies may provide, as external supplies, for the VPP to CPF, CNF to VNN, CPOS to GND and GND to CNEG pins. Note that between VPP to CPF and CNF to VNN, two must be floating supplies. (See <a href="#">Logic Control Table</a> .)
9	PIN5	Input logic control of high-voltage output P-FET for Channel 5; High = on; Low = off (See <a href="#">Logic Control Table</a> .)
10	NIN5	Input logic control of high-voltage output N-FET for Channel 5; High = on; Low = off (See <a href="#">Logic Control Table</a> .)
11	PIN6	Input logic control of high-voltage output P-FET for Channel 6; High = on; Low = off (See <a href="#">Logic Control Table</a> .)
12	NIN6	Input logic control of high-voltage output N-FET for Channel 6; High = on; Low = off (See <a href="#">Logic Control Table</a> .)
13	PIN7	Input logic control of high-voltage output P-FET for Channel 7; High = on; Low = off (See <a href="#">Logic Control Table</a> .)
14	NIN7	Input logic control of high-voltage output N-FET for Channel 7; High = on; Low = off (See <a href="#">Logic Control Table</a> .)
15	PIN8	Input logic control of high-voltage output P-FET for Channel 8; High = on; Low = off (See <a href="#">Logic Control Table</a> .)
16	NIN8	Input logic control of high-voltage output N-FET for Channel 8; High = on; Low = off (See <a href="#">Logic Control Table</a> .)
17	VLL	Logic supply voltage and reference input (+3.3V)
18	GND	Logic and circuit return ground (0V)
19	VDD	Positive voltage power supply (+3.3V)
20	VPP	Positive high-voltage power supply (+10V to +60V)
21	VPP	
22	VPP	
23	CPF	Built-in linear voltage VPF regulator output decoupling capacitor pin, 1 uF from VPP to CPF for every CPF pin
24	CNF	Built-in linear voltage VNF regulator output decoupling capacitor pin, 1 uF from CNF to VNN for every CNF pin
25	VNN	Negative high-voltage power supply (-10V to -60V)
26	VNN	
27	VNN	
28	TX8	T <sub>x</sub> pulser Channel 8 output
29	RGND	Damping ground and bleed resistors common return ground

# HV7350

**TABLE 2-1: PAD FUNCTION TABLE (CONTINUED)**

Pin Number	Pin Name	Description
30	TX7	T <sub>X</sub> pulser Channel 7 output
31	RGND	Damping ground and bleed resistors common return ground
32	TX6	T <sub>X</sub> pulser Channel 6 output
33	RGND	Damping ground and bleed resistors common return ground
34	TX5	T <sub>X</sub> pulser Channel 5 output
35	CNEG	Built-in linear voltage -5V regulator output decoupling capacitor pin, 1 uF from CNEG to GND
36	CPOS	Built-in linear voltage +5V regulator output decoupling capacitor pin, 1 uF from CPOS to GND
37	TX4	T <sub>X</sub> pulser Channel 4 output
38	RGND	Damping ground and bleed resistors common return ground
39	TX3	T <sub>X</sub> pulser Channel 3 output
40	RGND	Damping ground and bleed resistors common return ground
41	TX2	T <sub>X</sub> pulser Channel 2 output
42	RGND	Damping ground and bleed resistors common return ground
43	TX1	T <sub>X</sub> pulser Channel 1 output
44	VNN	Negative high-voltage power supply (-10V to -60V)
45	VNN	
46	VNN	
47	CNF	Built-in linear voltage VNF regulator output decoupling capacitor pin, 1 uF from CNF to VNN for every CNF pin
48	CPF	Built-in linear voltage VPF regulator output decoupling capacitor pin, 1 uF from VPP to CPF for every CPF pin
49	VPP	Positive high-voltage power supply (+10V to +60V)
50	VPP	
51	VPP	
52	VDD	Positive voltage power supply (+3.3V)
53	GND	Logic and circuit return ground (0V)
54	CLK	Retiming register clock input. Connect to VLL to disable the retiming function.
55	PIN1	Input logic control of high-voltage output P-FET for Channel 1; High = on; Low = off (See <a href="#">Logic Control Table</a> .)
56	NIN1	Input logic control of high-voltage output N-FET for Channel 1; High = on; Low = off (See <a href="#">Logic Control Table</a> .)
VSUB (Thermal Pad)		Substrate bottom is internally connected to the central thermal pad on the bottom of package. It must be connected to GND (0V) externally.



## 3.0 FUNCTIONAL DESCRIPTION

Follow the steps below to power up and power down the HV7350:

### POWER-UP AND POWER-DOWN SEQUENCE (Note 1)

Power-Up		Power-Down	
Step	Description	Step	Description
1	$V_{LL}$ with logic signal low	1	All logic signals go to low
2	$V_{DD}$	2	$V_{PP}$ and $V_{NN}$
3	REN = 1 (external supplies on)	3	REN = 0 (external supplies off)
4	$V_{PP}$ and $V_{NN}$	4	$V_{DD}$
5	Logic control signals active	5	$V_{LL}$

**Note 1:** Powering up or down in any arbitrary sequence will not damage the device. The power-up sequence and power-down sequence are only recommended to minimize possible inrush current.

### OUTPUT CURRENT AND $R_{ON}$ (Note 1, Note 4)

$I_{SC}$ <sup>2</sup>	$R_{onP}$	$R_{onN}$	$I_{DMP}$ <sup>3</sup>	$R_{onDP}$	$R_{onDN}$
1.5A	13 $\Omega$	6.5 $\Omega$	1.5A	13 $\Omega$	8 $\Omega$

**Note 1:**  $V_{PP}/V_{NN} = +/-60V$ ;  $V_{DD} = +3.3V$ ; REN = 1

**2:**  $I_{SC}$  is current into 1 $\Omega$  to GND.

**3:**  $I_{DMP}$  is current from +/-30V connected to  $T_X$  pin.

**4:** Maximum pulse width for current measurement on  $T_X$  pin is 20 ns.

# HV7350

---

## 4.0 PACKAGING INFORMATION

### 4.1 Package Marking Information

56-lead QFN

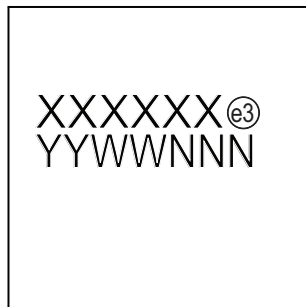

Example

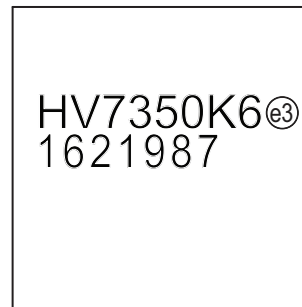

<b>Legend:</b>	XX...X	Product Code or Customer-specific information
	Y	Year code (last digit of calendar year)
	YY	Year code (last 2 digits of calendar year)
	WW	Week code (week of January 1 is week '01')
	NNN	Alphanumeric traceability code
	<sup>ⓔ3</sup>	Pb-free JEDEC <sup>®</sup> designator for Matte Tin (Sn)
	*	This package is Pb-free. The Pb-free JEDEC designator ( <sup>ⓔ3</sup> ) can be found on the outer packaging for this package.
<b>Note:</b>	In the event the full Microchip part number cannot be marked on one line, it will be carried over to the next line, thus limiting the number of available characters for product code or customer-specific information. Package may or not include the corporate logo.	

## 56-Lead QFN Package Outline (K6) 8.00x8.00mm body, 1.00mm height (max), 0.50mm pitch

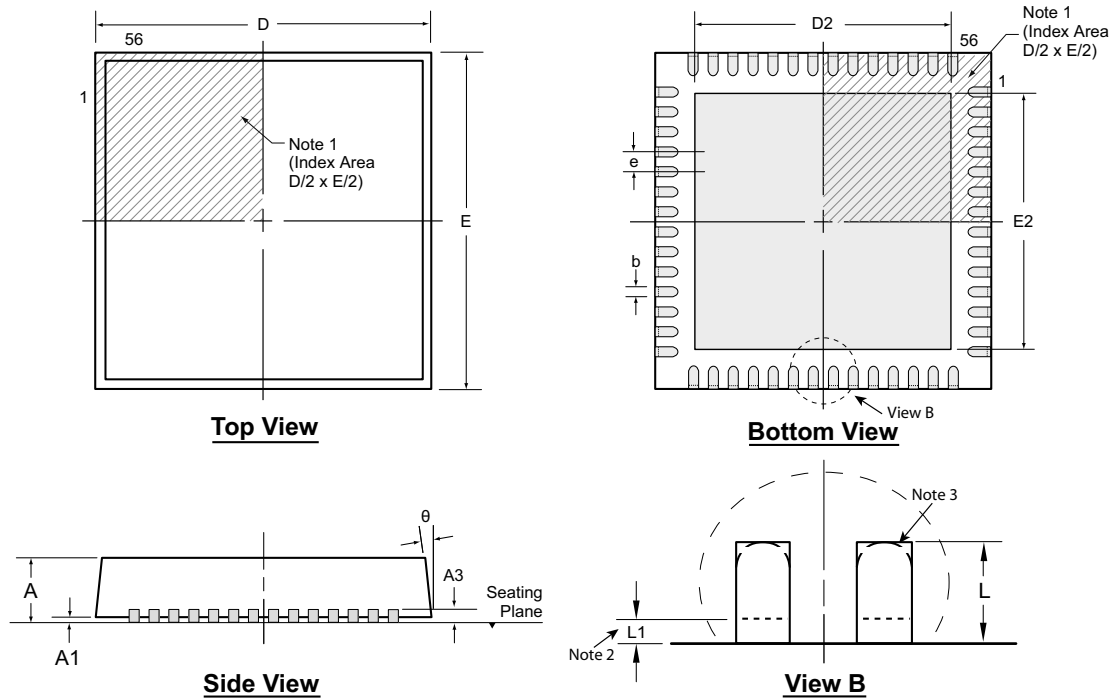

Note: For the most current package drawings, see the Microchip Packaging Specification at [www.microchip.com/packaging](http://www.microchip.com/packaging).

**Notes:**

1. A Pin 1 identifier must be located in the index area indicated. The Pin 1 identifier can be: a molded mark/identifier; an embedded metal marker; or a printed indicator.
2. Depending on the method of manufacturing, a maximum of 0.15mm pullback (L1) may be present.
3. The inner tip of the lead may be either rounded or square.

Symbol	A	A1	A3	b	D	D2	E	E2	e	L	L1	$\theta$	
Dimension (mm)	MIN	0.80	0.00	0.20 REF	0.18	7.85*	2.75	7.85*	2.75	0.50 BSC	0.30	0.00	0°
	NOM	0.90	0.02		0.25	8.00	5.70	8.00	5.70		0.40	-	-
	MAX	1.00	0.05		0.30	8.15*	6.70†	8.15*	6.70†		0.50	0.15	14°

JEDEC Registration MO-220, Variation VLLD-2, Issue K, June 2006.

\* This dimension is not specified in the JEDEC drawing.

† This dimension differs from the JEDEC drawing.

**Drawings are not to scale.**

# HV7350

---

NOTES:

## APPENDIX A: REVISION HISTORY

### Revision A (October 2016)

- Converted Supertex Doc# DSFP-HV7350 to Microchip DS20005627A
- Changed the packaging quantity of 56-lead QFN M937 from 2000/Reel to 3000/Reel
- Made minor text changes throughout the document

# HV7350

## PRODUCT IDENTIFICATION SYSTEM

To order or obtain information, e.g., on pricing or delivery, contact your local Microchip representative or sales office.

<u>PART NO.</u>	<u>XX</u>	-	<u>X</u>	-	<u>X</u>
Device	Package Options		Environmental		Media Type
Device:	HV7350	=	8-Channel High-Speed $\pm 60V \pm 1A$ Ultrasound RTZ Pulser		
Package:	K6	=	56-lead VQFN		
Environmental:	G	=	Lead (Pb)-free/RoHS-compliant Package		
Media Type:	(blank)	=	250/Tray for a K6 Package		
	M937	=	3000/Reel for a K6 Package		

**Examples:**

a) HV7350K6-G: 8-Channel High-Speed  $\pm 60V \pm 1A$  Ultrasound RTZ Pulser, 56-lead VQFN, 250/Tray

b) HV7350K6-G-M937: 8-Channel High-Speed  $\pm 60V \pm 1A$  Ultrasound RTZ Pulser, 56-lead VQFN, 3000/Reel

---

---

**Note the following details of the code protection feature on Microchip devices:**

- Microchip products meet the specification contained in their particular Microchip Data Sheet.
- Microchip believes that its family of products is one of the most secure families of its kind on the market today, when used in the intended manner and under normal conditions.
- There are dishonest and possibly illegal methods used to breach the code protection feature. All of these methods, to our knowledge, require using the Microchip products in a manner outside the operating specifications contained in Microchip's Data Sheets. Most likely, the person doing so is engaged in theft of intellectual property.
- Microchip is willing to work with the customer who is concerned about the integrity of their code.
- Neither Microchip nor any other semiconductor manufacturer can guarantee the security of their code. Code protection does not mean that we are guaranteeing the product as “unbreakable.”

Code protection is constantly evolving. We at Microchip are committed to continuously improving the code protection features of our products. Attempts to break Microchip's code protection feature may be a violation of the Digital Millennium Copyright Act. If such acts allow unauthorized access to your software or other copyrighted work, you may have a right to sue for relief under that Act.

---

Information contained in this publication regarding device applications and the like is provided only for your convenience and may be superseded by updates. It is your responsibility to ensure that your application meets with your specifications. MICROCHIP MAKES NO REPRESENTATIONS OR WARRANTIES OF ANY KIND WHETHER EXPRESS OR IMPLIED, WRITTEN OR ORAL, STATUTORY OR OTHERWISE, RELATED TO THE INFORMATION, INCLUDING BUT NOT LIMITED TO ITS CONDITION, QUALITY, PERFORMANCE, MERCHANTABILITY OR FITNESS FOR PURPOSE. Microchip disclaims all liability arising from this information and its use. Use of Microchip devices in life support and/or safety applications is entirely at the buyer's risk, and the buyer agrees to defend, indemnify and hold harmless Microchip from any and all damages, claims, suits, or expenses resulting from such use. No licenses are conveyed, implicitly or otherwise, under any Microchip intellectual property rights unless otherwise stated.

*Microchip received ISO/TS-16949:2009 certification for its worldwide headquarters, design and wafer fabrication facilities in Chandler and Tempe, Arizona; Gresham, Oregon and design centers in California and India. The Company's quality system processes and procedures are for its PIC® MCUs and dsPIC® DSCs, KEELOQ® code hopping devices, Serial EEPROMs, microperipherals, nonvolatile memory and analog products. In addition, Microchip's quality system for the design and manufacture of development systems is ISO 9001:2000 certified.*

**QUALITY MANAGEMENT SYSTEM  
CERTIFIED BY DNV  
= ISO/TS 16949 =**

### Trademarks

The Microchip name and logo, the Microchip logo, AnyRate, dsPIC, FlashFlex, flexPWR, Heldo, JukeBlox, KeeLoq, KeeLoq logo, Klear, LANCheck, LINK MD, MediaLB, MOST, MOST logo, MPLAB, OptoLyzer, PIC, PICSTART, PIC32 logo, RightTouch, SpyNIC, SST, SST Logo, SuperFlash and UNI/O are registered trademarks of Microchip Technology Incorporated in the U.S.A. and other countries.

ClockWorks, The Embedded Control Solutions Company, ETHERSYNCH, Hyper Speed Control, HyperLight Load, IntelliMOS, mTouch, Precision Edge, and QUIET-WIRE are registered trademarks of Microchip Technology Incorporated in the U.S.A.

Analog-for-the-Digital Age, Any Capacitor, AnyIn, AnyOut, BodyCom, chipKIT, chipKIT logo, CodeGuard, dsPICDEM, dsPICDEM.net, Dynamic Average Matching, DAM, ECAN, EtherGREEN, In-Circuit Serial Programming, ICSP, Inter-Chip Connectivity, JitterBlocker, KlearNet, KlearNet logo, MiWi, motorBench, MPASM, MPF, MPLAB Certified logo, MPLIB, MPLINK, MultiTRAK, NetDetach, Omniscient Code Generation, PICDEM, PICDEM.net, PICkit, PICtail, PureSilicon, RightTouch logo, REAL ICE, Ripple Blocker, Serial Quad I/O, SQL, SuperSwitcher, SuperSwitcher II, Total Endurance, TSHARC, USBCheck, VariSense, ViewSpan, WiperLock, Wireless DNA, and ZENA are trademarks of Microchip Technology Incorporated in the U.S.A. and other countries.

SQTP is a service mark of Microchip Technology Incorporated in the U.S.A.

Silicon Storage Technology is a registered trademark of Microchip Technology Inc. in other countries.

GestIC is a registered trademarks of Microchip Technology Germany II GmbH & Co. KG, a subsidiary of Microchip Technology Inc., in other countries.

All other trademarks mentioned herein are property of their respective companies.

© 2016, Microchip Technology Incorporated, Printed in the U.S.A., All Rights Reserved.

ISBN: 978-1-5224-0997-7



# MICROCHIP

## Worldwide Sales and Service

### AMERICAS

#### Corporate Office

2355 West Chandler Blvd.  
Chandler, AZ 85224-6199

Tel: 480-792-7200

Fax: 480-792-7277

Technical Support:

[http://www.microchip.com/  
support](http://www.microchip.com/support)

Web Address:

[www.microchip.com](http://www.microchip.com)

#### Atlanta

Duluth, GA

Tel: 678-957-9614

Fax: 678-957-1455

#### Austin, TX

Tel: 512-257-3370

#### Boston

Westborough, MA

Tel: 774-760-0087

Fax: 774-760-0088

#### Chicago

Itasca, IL

Tel: 630-285-0071

Fax: 630-285-0075

#### Cleveland

Independence, OH

Tel: 216-447-0464

Fax: 216-447-0643

#### Dallas

Addison, TX

Tel: 972-818-7423

Fax: 972-818-2924

#### Detroit

Novi, MI

Tel: 248-848-4000

#### Houston, TX

Tel: 281-894-5983

#### Indianapolis

Noblesville, IN

Tel: 317-773-8323

Fax: 317-773-5453

#### Los Angeles

Mission Viejo, CA

Tel: 949-462-9523

Fax: 949-462-9608

#### New York, NY

Tel: 631-435-6000

#### San Jose, CA

Tel: 408-735-9110

#### Canada - Toronto

Tel: 905-695-1980

Fax: 905-695-2078

### ASIA/PACIFIC

#### Asia Pacific Office

Suites 3707-14, 37th Floor  
Tower 6, The Gateway  
Harbour City, Kowloon

#### Hong Kong

Tel: 852-2943-5100

Fax: 852-2401-3431

#### Australia - Sydney

Tel: 61-2-9868-6733

Fax: 61-2-9868-6755

#### China - Beijing

Tel: 86-10-8569-7000

Fax: 86-10-8528-2104

#### China - Chengdu

Tel: 86-28-8665-5511

Fax: 86-28-8665-7889

#### China - Chongqing

Tel: 86-23-8980-9588

Fax: 86-23-8980-9500

#### China - Dongguan

Tel: 86-769-8702-9880

#### China - Guangzhou

Tel: 86-20-8755-8029

#### China - Hangzhou

Tel: 86-571-8792-8115

Fax: 86-571-8792-8116

#### China - Hong Kong SAR

Tel: 852-2943-5100

Fax: 852-2401-3431

#### China - Nanjing

Tel: 86-25-8473-2460

Fax: 86-25-8473-2470

#### China - Qingdao

Tel: 86-532-8502-7355

Fax: 86-532-8502-7205

#### China - Shanghai

Tel: 86-21-5407-5533

Fax: 86-21-5407-5066

#### China - Shenyang

Tel: 86-24-2334-2829

Fax: 86-24-2334-2393

#### China - Shenzhen

Tel: 86-755-8864-2200

Fax: 86-755-8203-1760

#### China - Wuhan

Tel: 86-27-5980-5300

Fax: 86-27-5980-5118

#### China - Xian

Tel: 86-29-8833-7252

Fax: 86-29-8833-7256

### ASIA/PACIFIC

#### China - Xiamen

Tel: 86-592-2388138

Fax: 86-592-2388130

#### China - Zhuhai

Tel: 86-756-3210040

Fax: 86-756-3210049

#### India - Bangalore

Tel: 91-80-3090-4444

Fax: 91-80-3090-4123

#### India - New Delhi

Tel: 91-11-4160-8631

Fax: 91-11-4160-8632

#### India - Pune

Tel: 91-20-3019-1500

#### Japan - Osaka

Tel: 81-6-6152-7160

Fax: 81-6-6152-9310

#### Japan - Tokyo

Tel: 81-3-6880-3770

Fax: 81-3-6880-3771

#### Korea - Daegu

Tel: 82-53-744-4301

Fax: 82-53-744-4302

#### Korea - Seoul

Tel: 82-2-554-7200

Fax: 82-2-558-5932 or

82-2-558-5934

#### Malaysia - Kuala Lumpur

Tel: 60-3-6201-9857

Fax: 60-3-6201-9859

#### Malaysia - Penang

Tel: 60-4-227-8870

Fax: 60-4-227-4068

#### Philippines - Manila

Tel: 63-2-634-9065

Fax: 63-2-634-9069

#### Singapore

Tel: 65-6334-8870

Fax: 65-6334-8850

#### Taiwan - Hsin Chu

Tel: 886-3-5778-366

Fax: 886-3-5770-955

#### Taiwan - Kaohsiung

Tel: 886-7-213-7828

#### Taiwan - Taipei

Tel: 886-2-2508-8600

Fax: 886-2-2508-0102

#### Thailand - Bangkok

Tel: 66-2-694-1351

Fax: 66-2-694-1350

### EUROPE

#### Austria - Wels

Tel: 43-7242-2244-39

Fax: 43-7242-2244-393

#### Denmark - Copenhagen

Tel: 45-4450-2828

Fax: 45-4485-2829

#### France - Paris

Tel: 33-1-69-53-63-20

Fax: 33-1-69-30-90-79

#### Germany - Dusseldorf

Tel: 49-2129-3766400

#### Germany - Karlsruhe

Tel: 49-721-625370

#### Germany - Munich

Tel: 49-89-627-144-0

Fax: 49-89-627-144-44

#### Italy - Milan

Tel: 39-0331-742611

Fax: 39-0331-466781

#### Italy - Venice

Tel: 39-049-7625286

#### Netherlands - Drunen

Tel: 31-416-690399

Fax: 31-416-690340

#### Poland - Warsaw

Tel: 48-22-3325737

#### Spain - Madrid

Tel: 34-91-708-08-90

Fax: 34-91-708-08-91

#### Sweden - Stockholm

Tel: 46-8-5090-4654

#### UK - Wokingham

Tel: 44-118-921-5800

Fax: 44-118-921-5820

06/23/16